



UTM URBANIZACIÓN
X: 669726
Y: 4163340

PROMOTOR	UPCT	DOMICILIO	Piza. del Cronista Isidoro Valtverde (30202)(Cartagena)
TITULAR FINAL	IBERDROLA	SITUACION INSTALACION	Cartagena
C.I.F.	TELEFONO	PLANODE	PROYECTO
FECHA	MODIFICA	SITUACION	ELECTRIFICACION DE
09	FEB	PLANO	POLIGONO RESIDENCIAL
EXPEDIENTE	ESCALA	1	
	S/E	A-3	
Lorena Pardo Fernandez		INGENIERO TECNICO INDUSTRIAL	



UTM URBANIZACIÓN
X: 669726
Y: 4163340

		INGENIERO TÉCNICO INDUSTRIAL	
PROMOTOR		DOMICILIO	
UPCT		Plza. del Cronista Isidoro Valverde (30202)(Cartagena)	
TITULAR FINAL		SITUACION INSTALACION	
IBERDROLA		Cartagena	
C.I.F.		PLANO DE	
TELEFONO		EMPLAZAMIENTO	
FECHA		FECHA	
09		FEB	
EXPEDIENTE		MODIFICA.	
S/E		ESCALA	
A-3		PLANO	
2		ELECTRIFICACIÓN DE POLIGONO RESIDENCIAL	
Lorena Pardo Fernandez			



UTM URBANIZACIÓN
 X: 669726
 Y: 4163340



Lorena Pardo Fernandez

PROMOTOR	UPCT	DOMICILIO	C.I.F.	PLANO DE	PROYECTO	INGENIERO TECNICO INDUSTRIAL
TITULAR FINAL	IBERDROLA	Piza. del Cronista Isidoro Valverde (30202)(Cartagena)	TELEFONO	EMPLAZAMIENTO	ELECTRIFICACIÓN DE	Lorena Pardo Fernandez
		SITUACION INSTALACION	FECHA	PLANO	POLIGONO RESIDENCIAL	
		Cartagena	09	ESCALA		
			EXPEDIENTE	S/E		
				A-3		
				2		



ZONA AGRICOLA

ZONA RESIDENCIAL

	PROMOTOR	DOMICILIO	C.I.F.	PLANO DE	PROYECTO	INGENIERO TECNICO INDUSTRIAL
	UPCT	Piza. del Cronista Isidoro Valverde (30202)(Cartagena)	TELEFONO	URBANIZACIÓN	ELECTRIFICACIÓN DE POLIGONO RESIDENCIAL	LORENA PARDO FERNANDEZ
IBERDROLA	Cartagena	SITUACION INSTALACION	FECHA MODIFICA	ESCALA		
			09	S/E		
			EXPEDIENTE	PLANO		
				3		

Lorena Pardo Fernandez

Lorena Pardo Fernandez

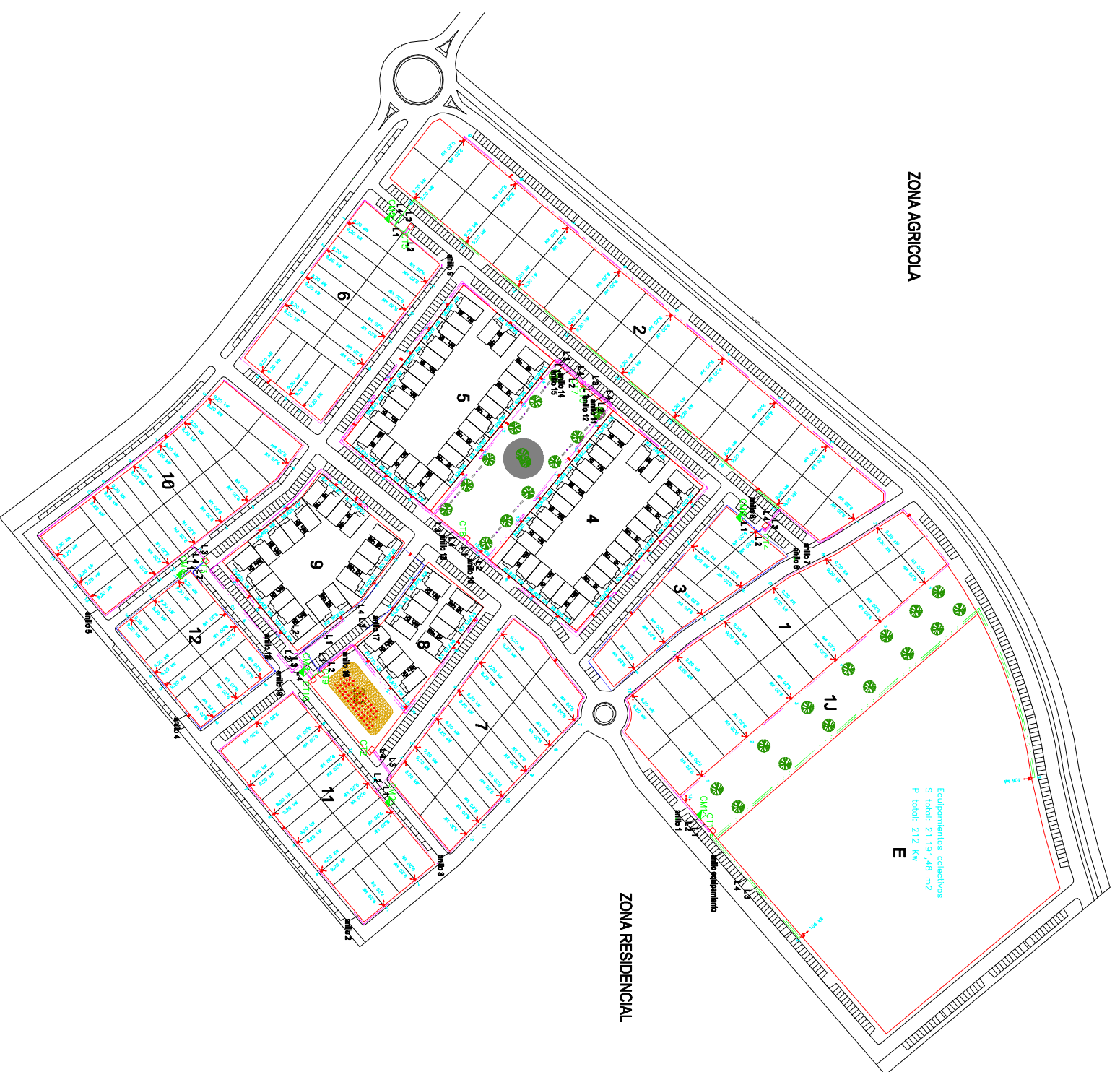

ZONA AGRICOLA

ZONA RESIDENCIAL

Equipamientos colectivos
S total: 211,91,48 m²
P total: 212 Kw
E



LEYENDA	
	CPT Material transformador
	Centro de mando para suministro
	Estación
LINEAS	
	Junto de enlace troncal
	Condensador No. 0,6/11 Kv 3x100 mm ² + 1x50 mm ² A.
	Condensador No. 0,6/11 Kv 3x100 mm ² + 1x50 mm ² A.
	Condensador No. 0,6/11 Kv 3x200 mm ² + 1x100 mm ² A.



PROMOTOR UPCT TITULAR FINAL IBERDROLA DOMICILIO Piza. del Cronista Isidoro Valverde (30202)(Cartagena) SITUACION INSTALACION Cartagena		C.I.F. TELEFONO FECHA FEB 09 MODIFICA EXPEDIENTE		PLANO DE PLANTA GENERAL BT ESCALA S/E PLANO 4		PROYECTO ELECTRIFICACIÓN DE POLIGONO RESIDENCIAL INGENIERO TECNICO INDUSTRIAL Lorena Pardo Fernandez	
---	--	---	--	---	--	---	--



LEYENDA
 □ Centro de transformación
 — Cableado tipo 12/25 kv (12x25) mm² 2L

 PROMOTOR UPCT TITULAR FINAL IBERDROLA	DOMICILIO Piza del Cronista Isidoro Valverde (30202)(Cartagena) SITUACION INSTALACION Cartagena	C.I.F. TELEFONO FECHA FEB 09 EXPEDIENTE S/E	PLANO DE PLANTA GENERAL MT ESCALA S/E A-3 	PROYECTO ELECTRIFICACIÓN DE POLIGONO RESIDENCIAL	INGENIERO TÉCNICO INDUSTRIAL Lorena Pardo Fernandez

Zanja en asfalto para 2 líneas MT ó BT

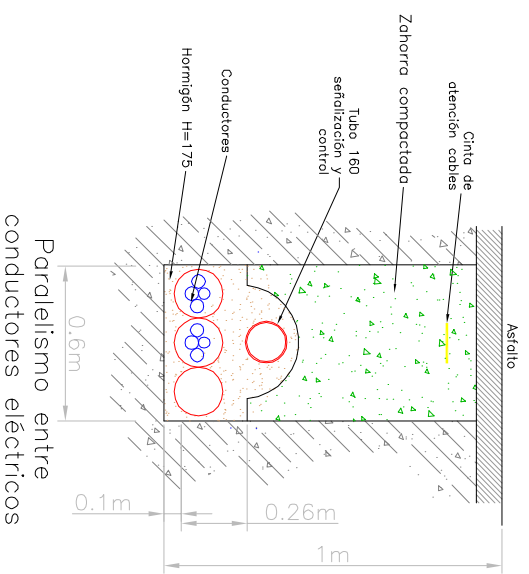

Paralelismo entre conductores eléctricos

Zanja en asfalto para 2 líneas MT ó BT

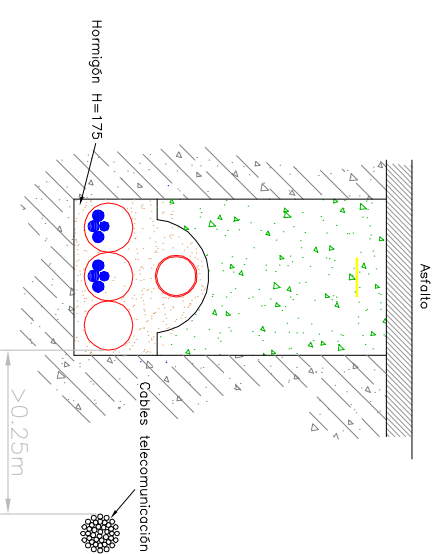

Paralelismo con cables de telecomunicación

Zanja en asfalto para 2 líneas MT ó BT

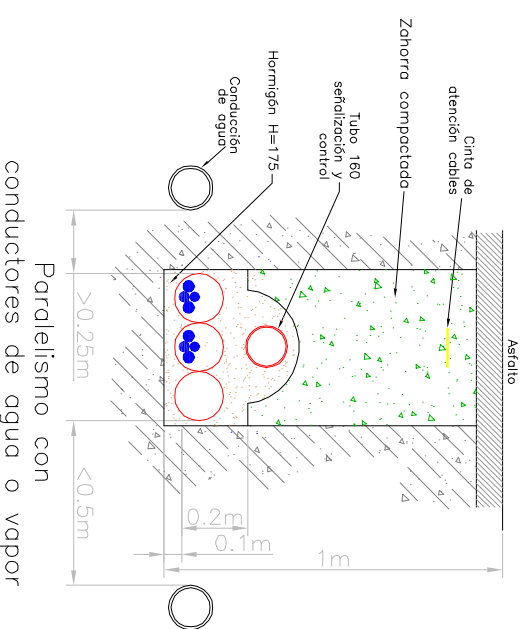

Paralelismo con conductores de agua o vapor

Zanja en asfalto para 2 líneas MT ó BT

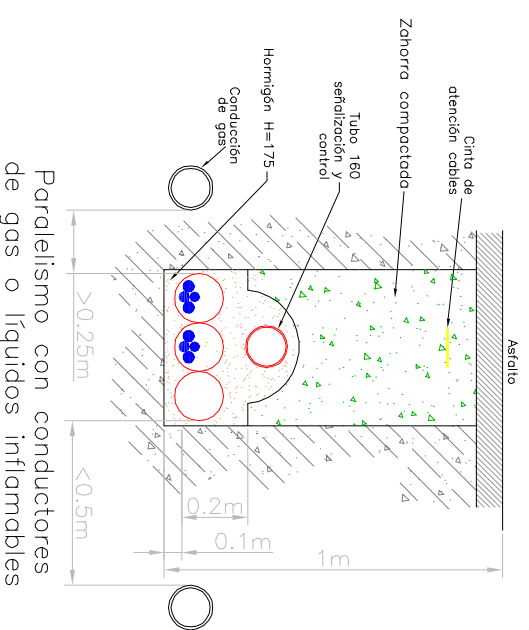

Paralelismo con conductores de gas o líquidos inflamables

Zanja en asfalto para 2 líneas MT ó BT

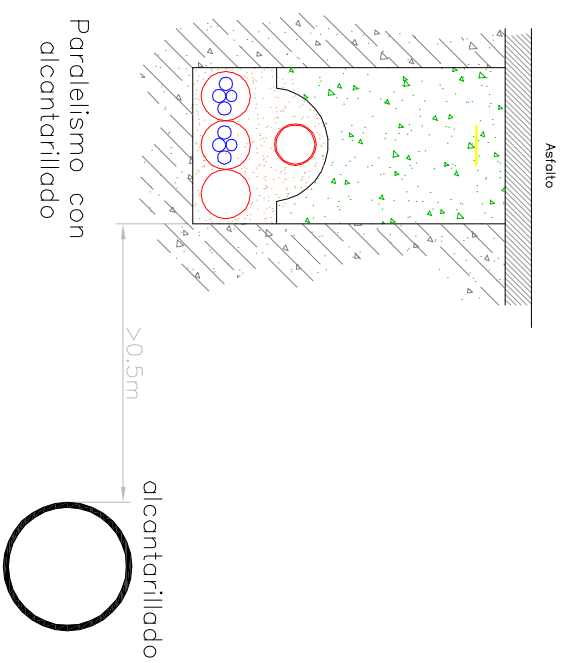

Paralelismo con cables de B.T.

	PROMOTOR UPCT	DOMICILIO Piza del Cronista Isidoro Valverde (30202) Cartagena	C.I.F. TEL. EFONO	PLANO DE paralelismo en asfaltos	PROYECTO ELECTRIFICACIÓN DE POLIGONO RESIDENCIAL	INGENIERO TECNICO INDUSTRIAL Lorena Pardo Fernandez
	TITULAR FINAL IBERDROLA	SITUACION INSTALACION Cartagena	FECHA FEB 09	MODIFICA. ESCALA A-3	PLANO 6/2	

Zanja en acera
para 2 líneas MT ó BT

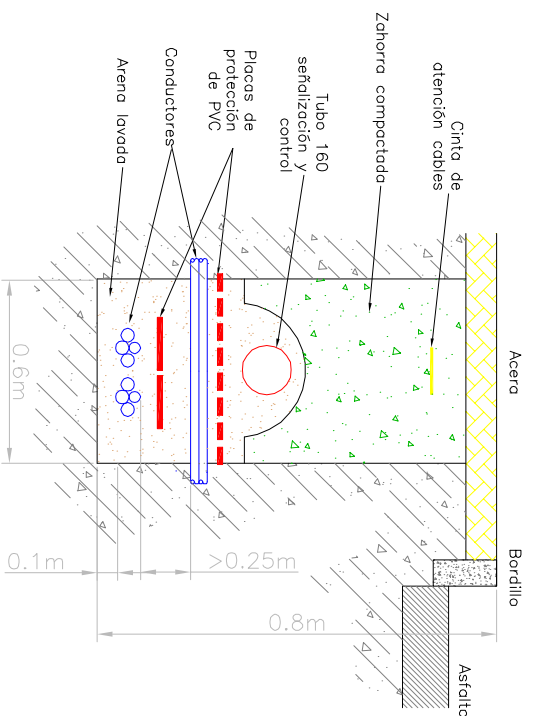

Cruzamiento entre
conductores eléctricos

Zanja en acera
para 2 líneas MT ó BT

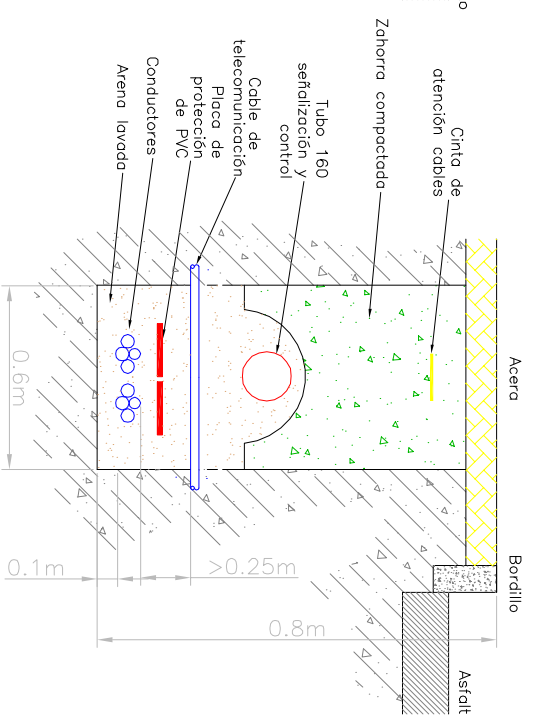

Cruzamiento con
cables de telecomunicación

Zanja en acera
para 2 líneas MT ó BT

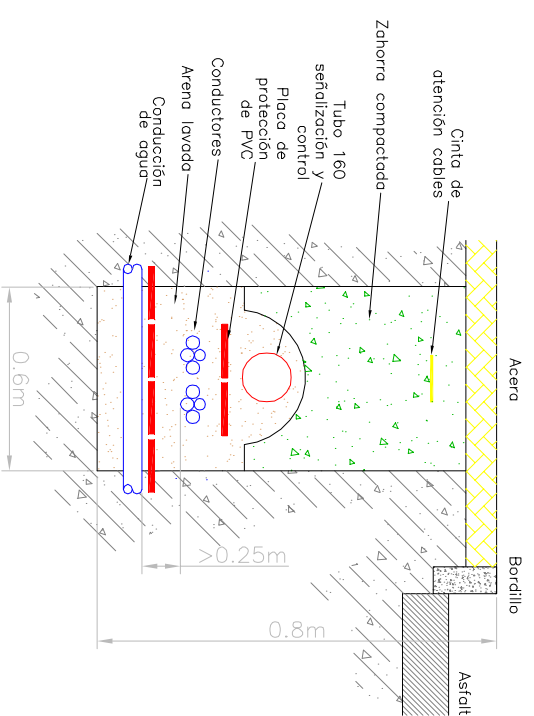

Cruzamiento con conducción
de agua, vapor o líquido inflamable.

Zanja en acera
para 2 líneas MT ó BT

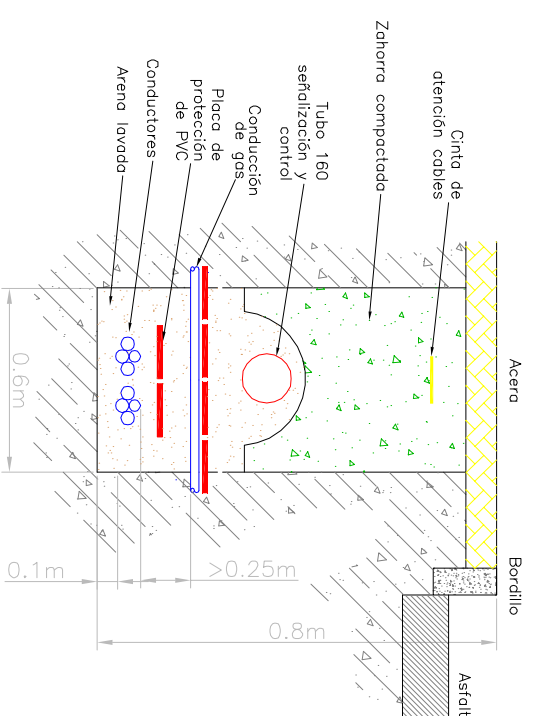

Cruzamiento con
conducción de gas

Zanja en asfalto
para 2 líneas MT ó BT

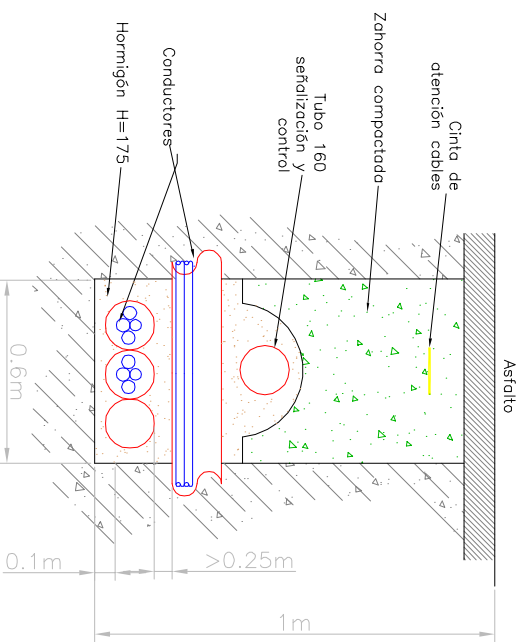

Cruzamiento entre
conductores eléctricos

Zanja en asfalto
para 2 líneas MT ó BT

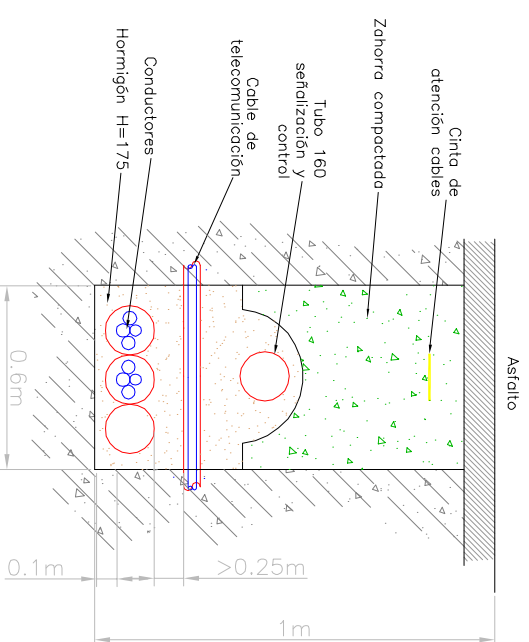

Cruzamiento con
cables de telecomunicación

Zanja en asfalto
para 2 líneas MT ó BT

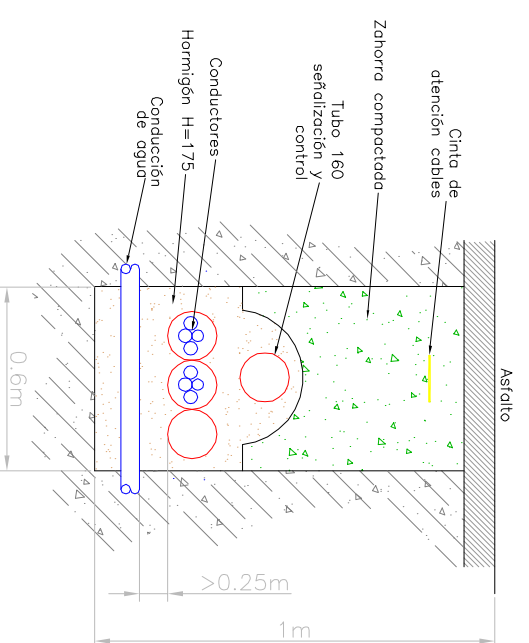

Cruzamiento con conducción
de agua, vapor o líquido inflamable.

Zanja en asfalto
para 2 líneas MT ó BT

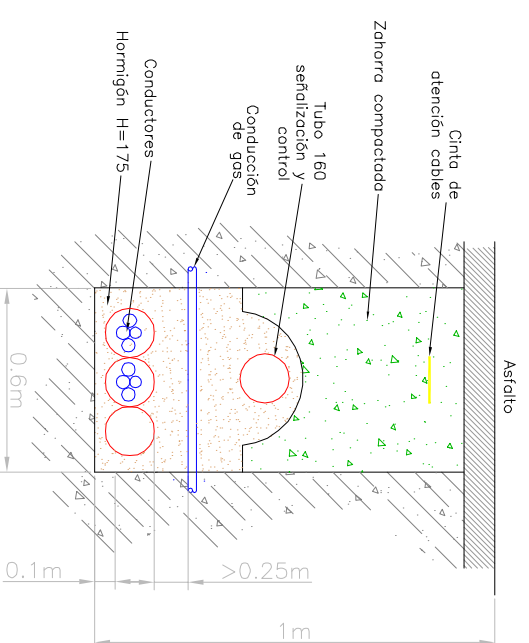

Cruzamiento con
conducción de gas

	PROMOTOR	DOMICILIO	C.I.F.	PLANO DE	PROYECTO	INGENIERO TECNICO INDUSTRIAL Lorena Prado Fernandez
	UPCT	Plza. del Cronista Isidoro Valverde (30202)(Cartagena)	TELEFONO	cruzamientos	ELECTRIFICACIÓN DE POLIGONO RESIDENCIAL	
	TITULAR FINAL	SITUACION INSTALACION	FECHA MODIFICA.	PLANO		
	IBERDROLA	Cartagena	09 EXPEDIENTE	6/1		
			ESCALA	A-3		
			SE			

Lorena Prado Fernandez

IBERDROLA

Cartagena

09 EXPEDIENTE

6/1

ELECTRIFICACIÓN DE POLIGONO RESIDENCIAL

Lorena Prado Fernandez

Zanja en acera para 2 líneas MT ó BT

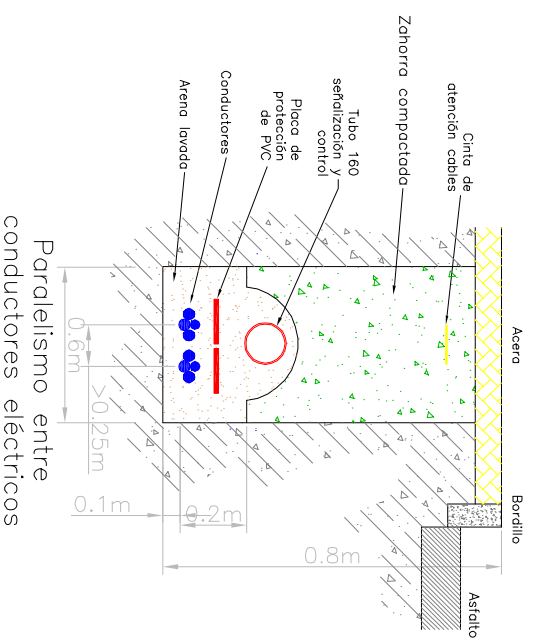

Paralelismo entre conductores eléctricos

Zanja en acera para 2 líneas MT ó BT

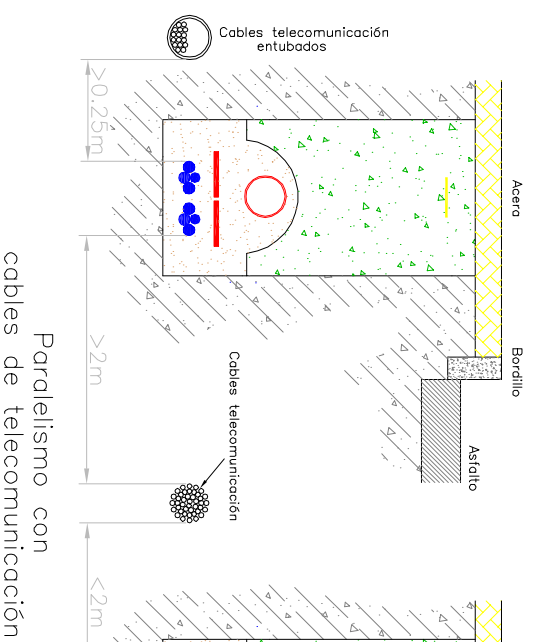

Paralelismo con cables de telecomunicación

Zanja en acera para 2 líneas MT ó BT

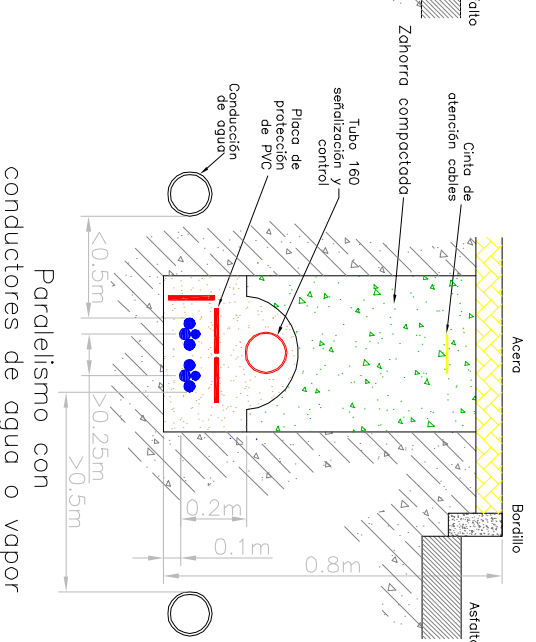

Paralelismo con conductores de agua o vapor

Zanja en acera para 2 líneas MT ó BT

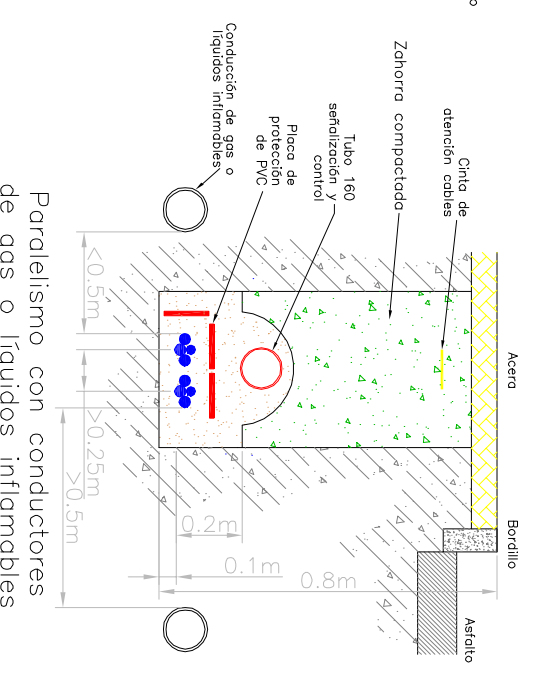

Paralelismo con conductores de gas o líquidos inflamables

Zanja en acera para 4 líneas BT y 2 líneas MT

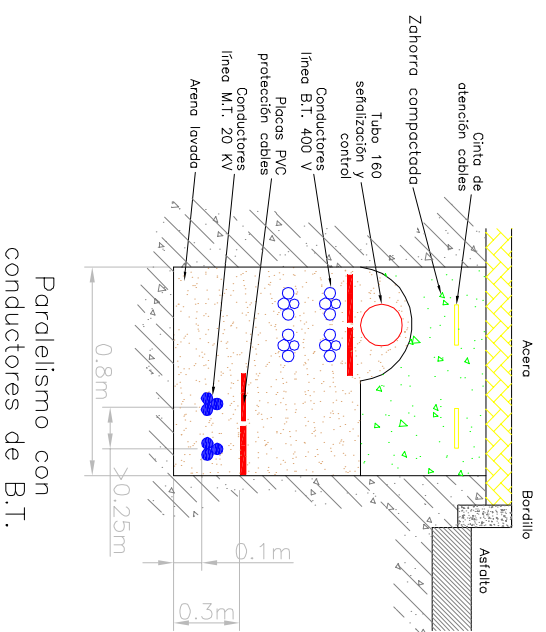

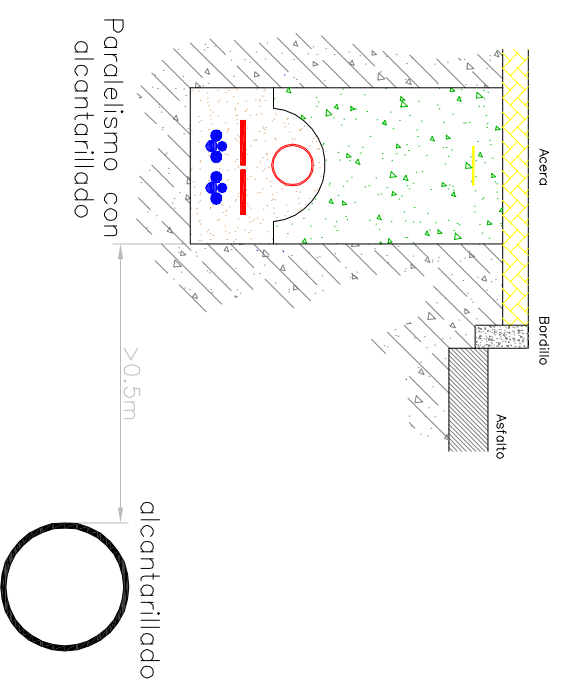

Paralelismo con conductores de B.T.

Zanja en acera para 2 líneas MT ó BT

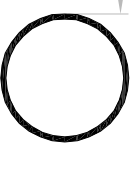

Paralelismo con alcantarillado



	PROMOTOR UPCT	DOMICILIO Piza del Cronista Isidoro Valverde (30202) (Cartagena)	C.I.F. TEL. EFONO	PLANO DE paralelismos en acera	PROYECTO ELECTRIFICACIÓN DE POLIGONO RESIDENCIAL	INGENIERO TECNICO INDUSTRIAL Lorena Pardo Fernandez
	TITULAR FINAL IBERDROLA	SITUACION INSTALACION Cartagena	FECHA FEB 09	MODIFICA ESCALA A-3	PLANO 6/3	

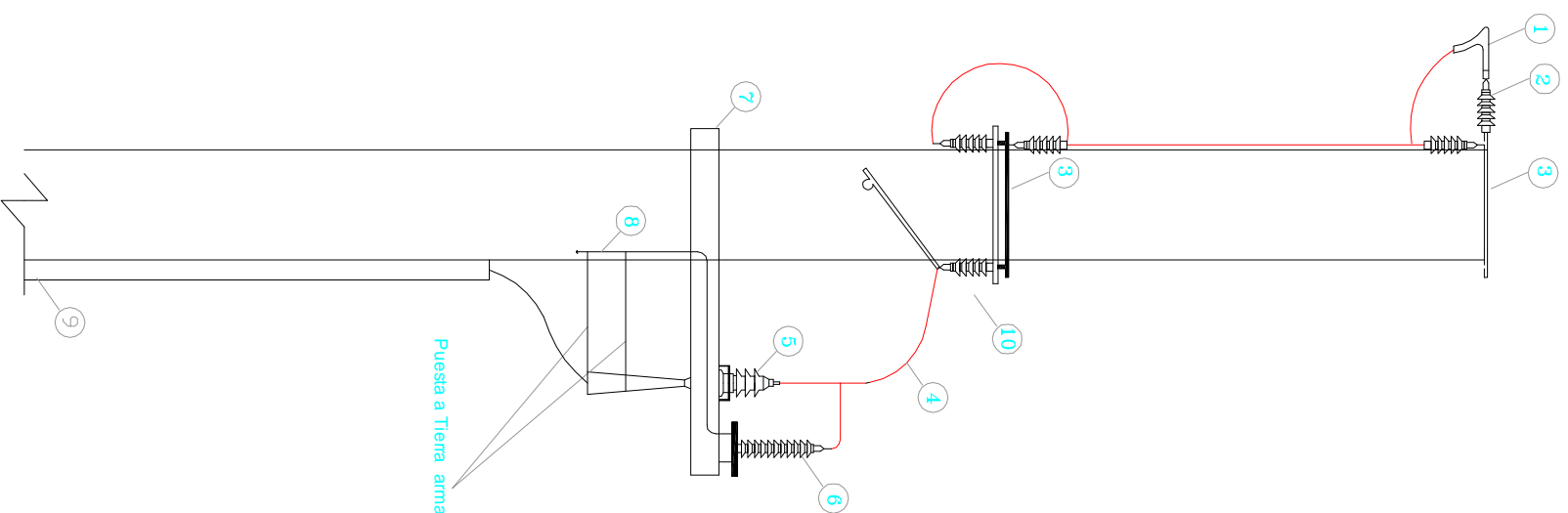

- 1 Grapa de amarre
- 2 Aislador composite
- 3 Curceta
- 4 Cable Cobre
- 5 Terminal exte. 12/20 Kv Cable seco
- 6 Parrarayos autovalvular 24 Kv
- 7 Cruceleta soporte terminal y pararrayos
- 8 Puesta a tierra autovalvulas
- 9 Tubo protector acero galvanizado
- 10 Seccionadores I ext. 24 Kv 6 Cortacircuitos fusibles XS colocados a 12 m del suelo (máximo)

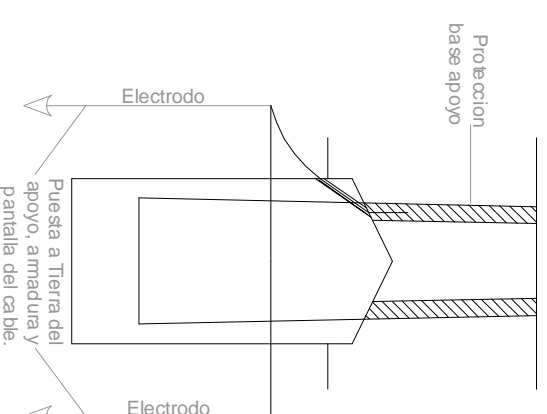

Lorena Pardo Fernandez

PROMOTOR	DOMICILIO	C.I.F.	PLANO DE	PROYECTO	INGENIERO TECNICO INDUSTRIAL
UPCT	Piza. del Cronista Isidoro Valverde (30202)(Cartagena)	TELEFONO	ENTRONQUE A/S	ELECTRIFICACIÓN DE	
TITULAR FINAL	SITUACION INSTALACION	FECHA	PLANO	POLIGONO RESIDENCIAL	
IBERDROLA	Cartagena	09	ESCALA		
		EXPEDIENTE	S/E		
			A-3		

Lorena Pardo Fernandez

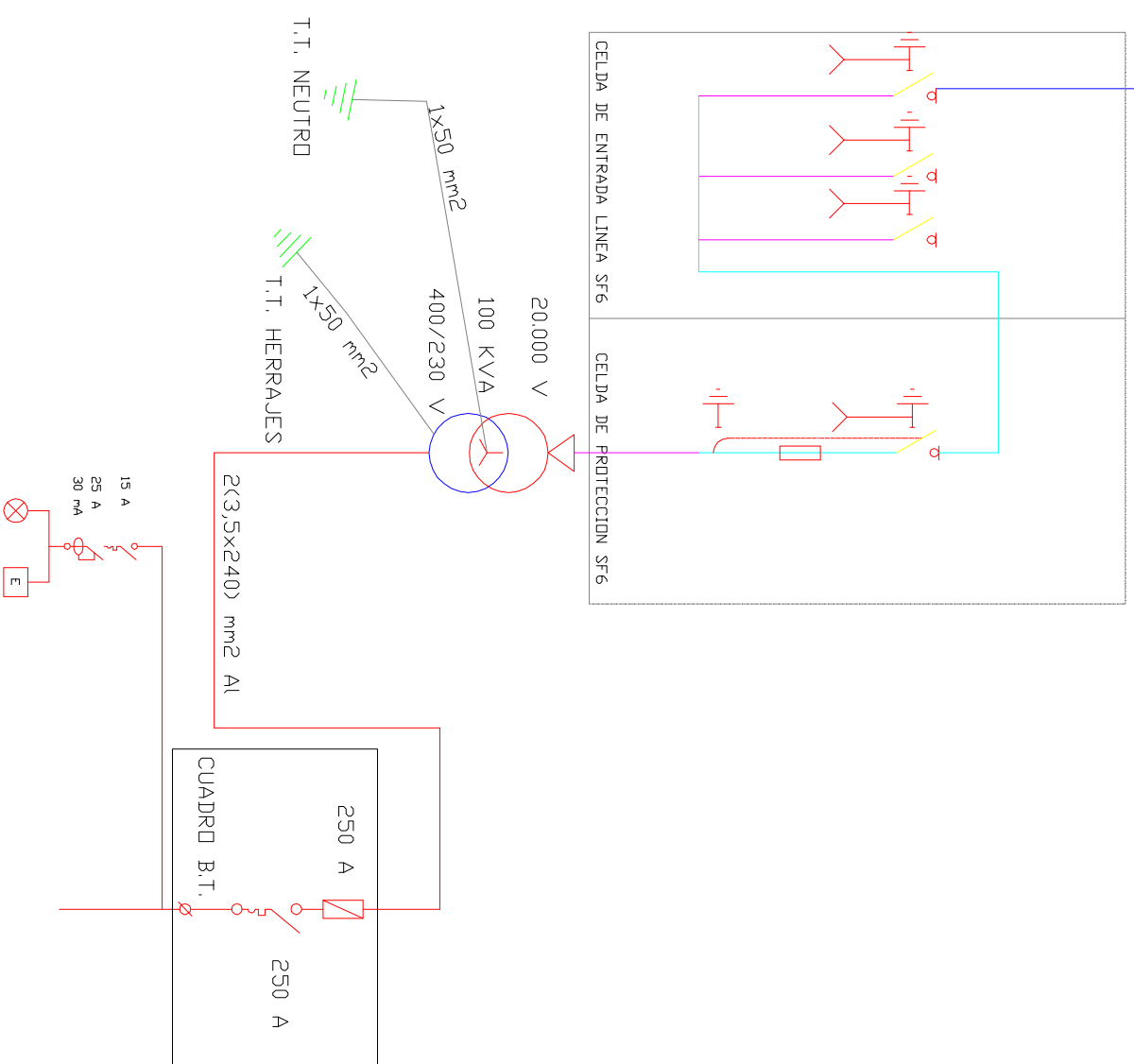
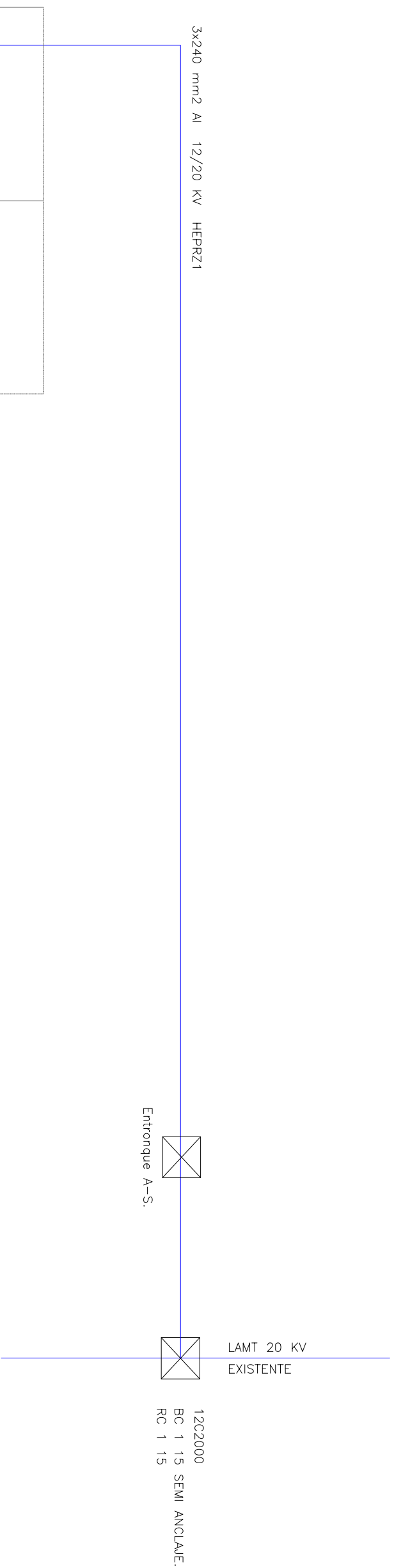

	PROMOTOR	UPCT	DOMICILIO	Piza, del Cronista Isidoro Valverde (30202)(Cartagena)	C.I.F.	PLANO DE	PROYECTO	INGENIERO TECNICO INDUSTRIAL Lorena Pardo Fernandez
	TITULAR FINAL	IBERDROLA	SITUACION INSTALACION	Cartagena	TEL EFRONO	ESQUEMA	ELECTRIFICACIÓN DE POLIGONO RESIDENCIAL	
					FECHA	ENTRONQUE		
					MODIFICA	PLANO		
					09	8		
					EXPEDIENTE	ESCALA		
					S/E	A-3		

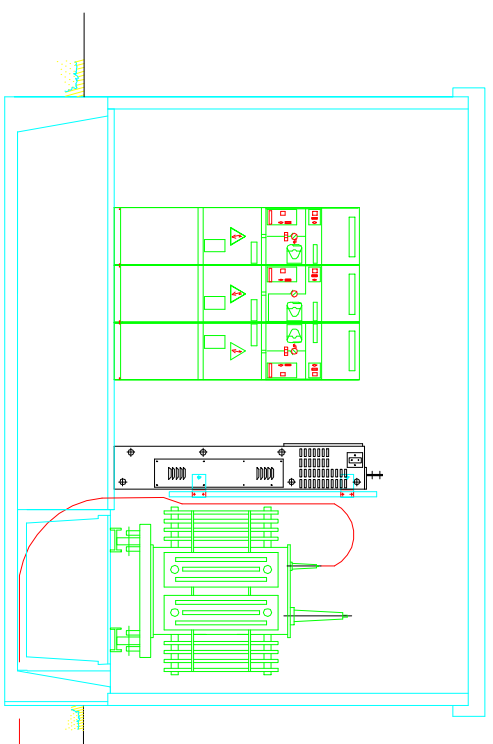

ALZADO

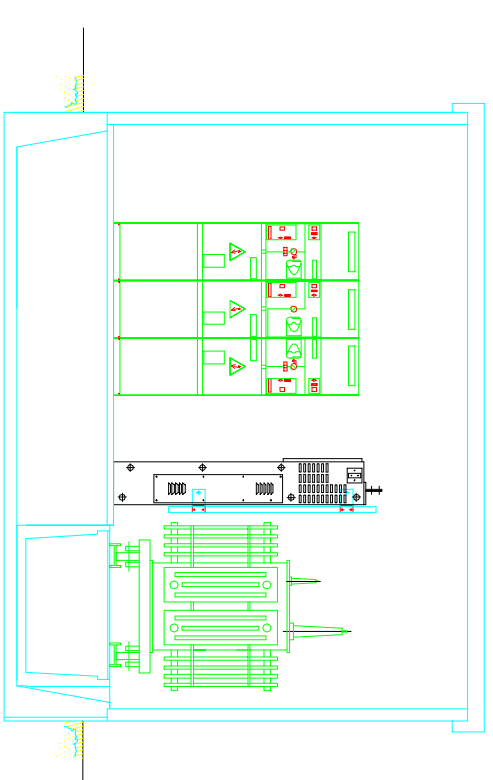

ALZADO

Pica Acero/Cu I.T.
2 mts.

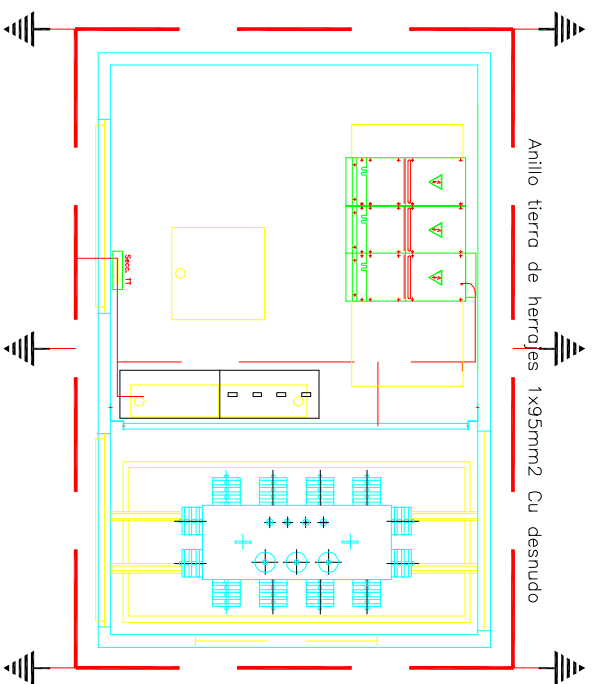

PLANTA

- 1- Placa de pinesos auxiliares
- 2- Far de quartes
- 3- Exhitor
- 4- Banqueta
- 5- Luminaria 2,38 W
- 6- Interruptor
- 7- Toma de corriente auxillar
- 8- Emergencia

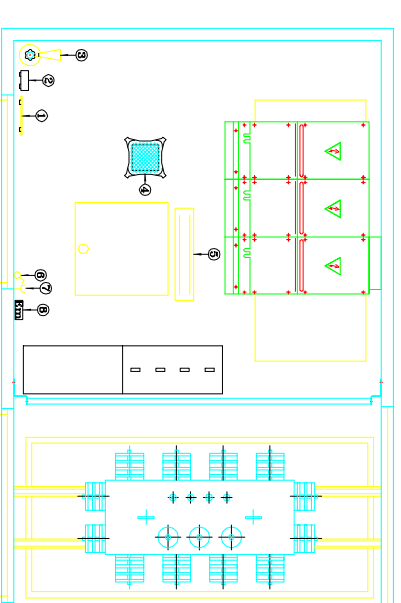

PLANTA

	PROMOTOR	DOMICILIO	C.I.F.	PLANO DE	PROYECTO	INGENIERO TECNICO INDUSTRIAL Lorena Pardo Fernandez
	UPCT	Piza del Cronista Isidoro Valverde (30/202) (Cartagena)	TEL. EFONO	instalaciones, seguridad y red de tierras	ELECTRIFICACIÓN DE POLIGONO RESIDENCIAL	
TITULAR FINAL	SITUACION INSTALACION	FECHA	MODIFICA.	ESCALA		
IBERDROLA	Cartagena	09		S/E		
		EXPEDIENTE		9/1		

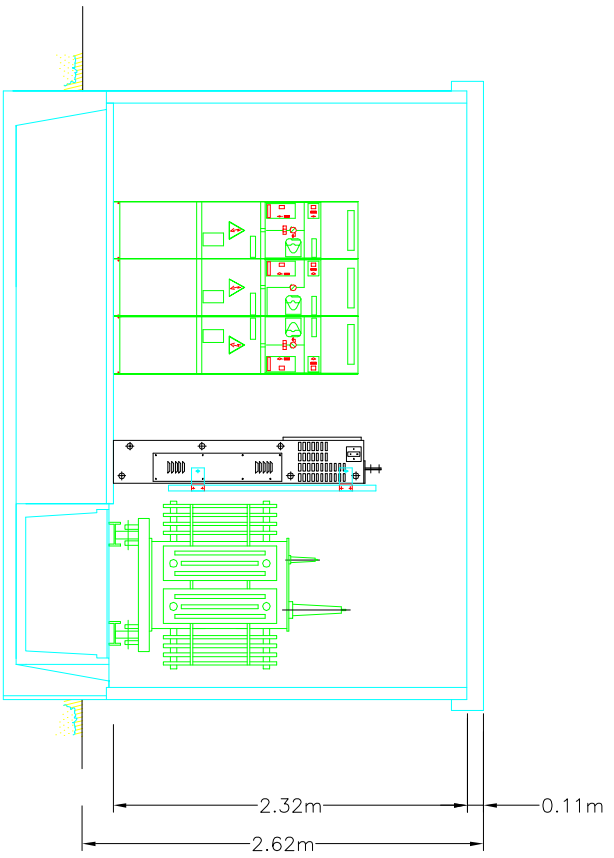

ALZADO

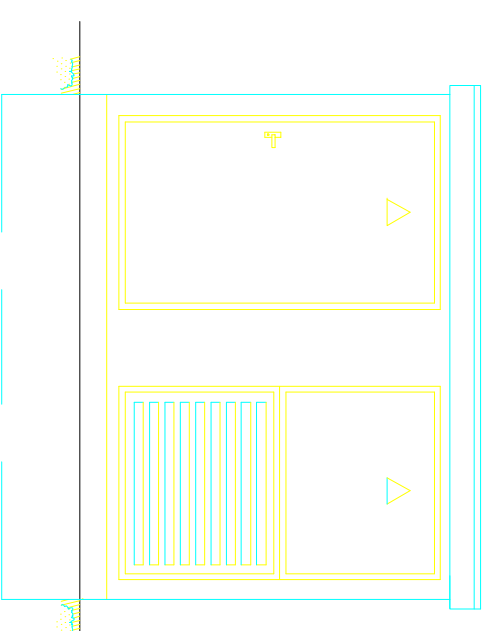

FACHADA

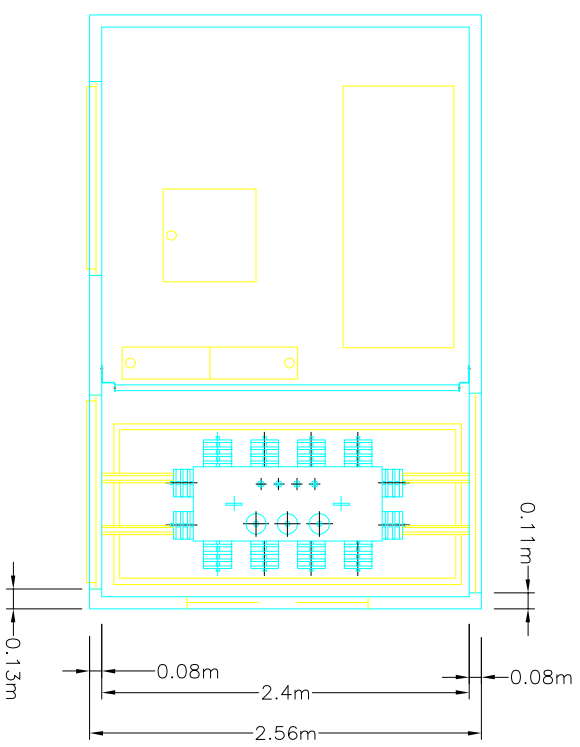

PLANTA

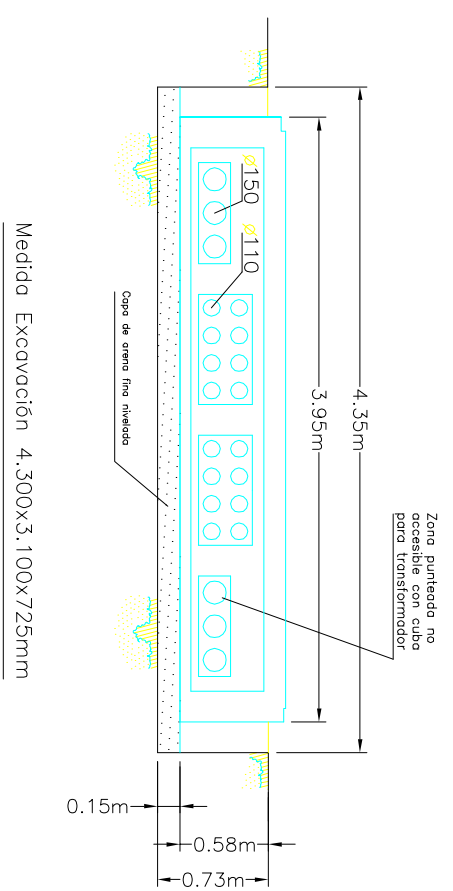

Lorena Pardo Fernandez

PROMOTOR	DOMICILIO	C.I.F.	PLANO DE	PROYECTO	INGENIERO TECNICO INDUSTRIAL
UPCT	Plza. del Cronista Isidoro Valverde (30/202) (Cartagena)	TEL.FONO	cotas	ELECTRIFICACIÓN DE POLIGONO RESIDENCIAL	
TITULAR FINAL	SITUACION INSTALACION	FECHA	MODIFICA.		
IBERDROLA	Cartagena	09 FEB			
		EXPEDIENTE	ESCALA	PLANO	
			S/E	9/2	

Lorena Pardo Fernandez

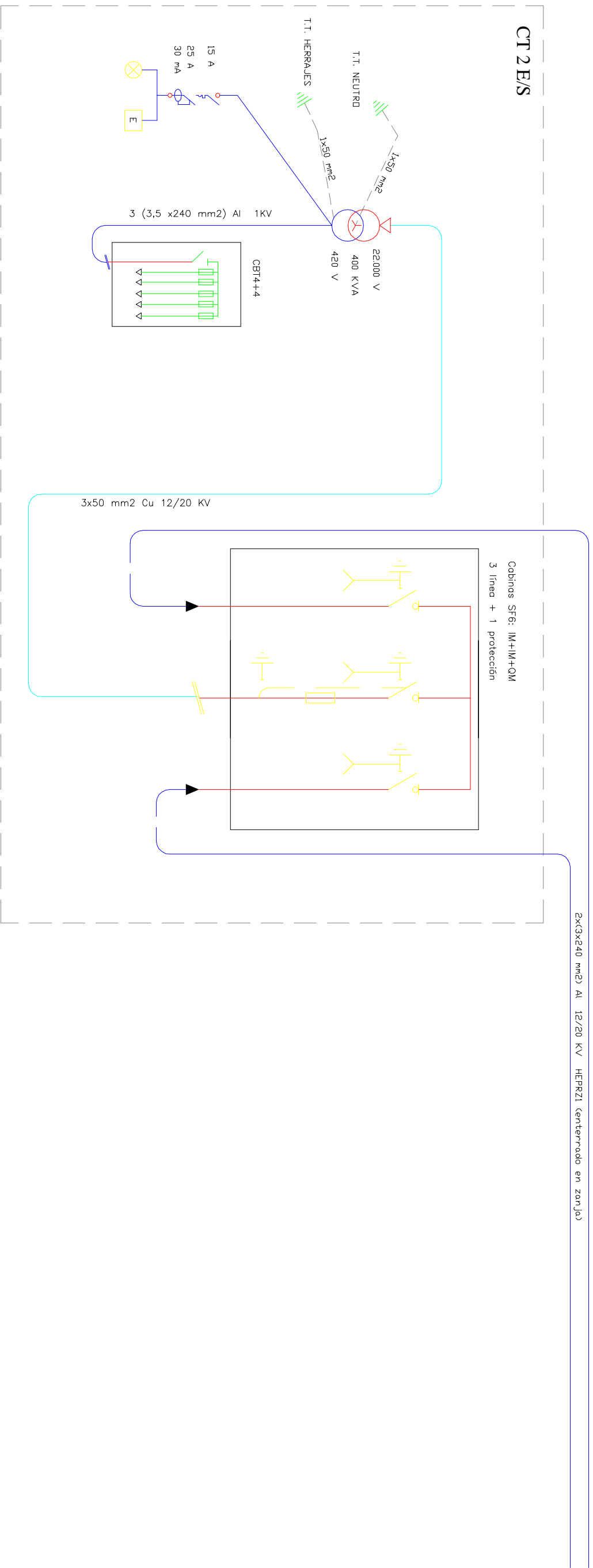

		PROMOTOR UPCT		DOMICILIO Plza. del Cronista Isidoro Valverde (30/202) Cartagena)		C.I.F. TEL.FONO		PLANO DE esquema eléctrico		PROYECTO ELECTRIFICACIÓN DE POLIGONO RESIDENCIAL		INGENIERO TECNICO INDUSTRIAL Lorena Pardo Fernandez	
TITULAR FINAL IBERDROLA		SITUACION INSTALACION Cartagena		FECHA 09 FEB		MODIFICA. EXPEDIENTE		ESCALA A:3		PLANO 9/3			

Lorena Pardo Fernandez

Lorena Pardo Fernandez

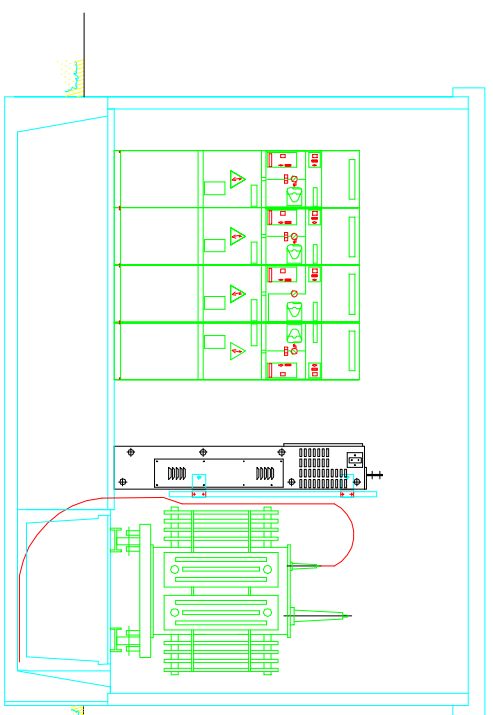

ALZADO

Tierra de neutro 1x95mm² Cu 0,6/1KV

Pica Acero/Cu I.T.
2 mts.

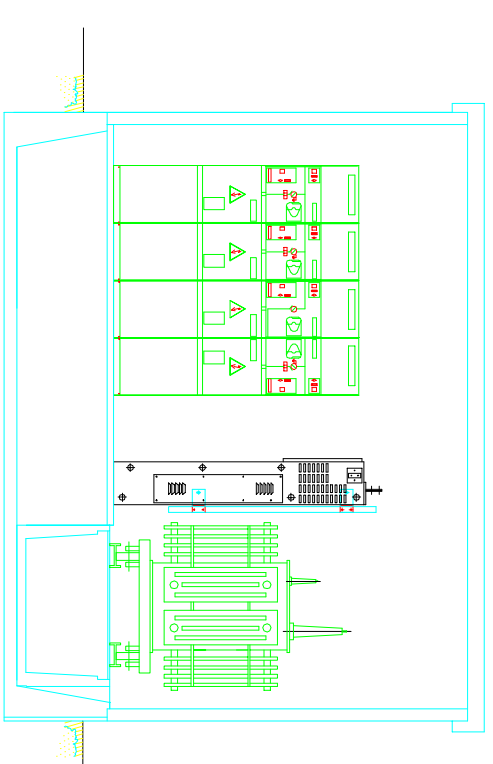

ALZADO

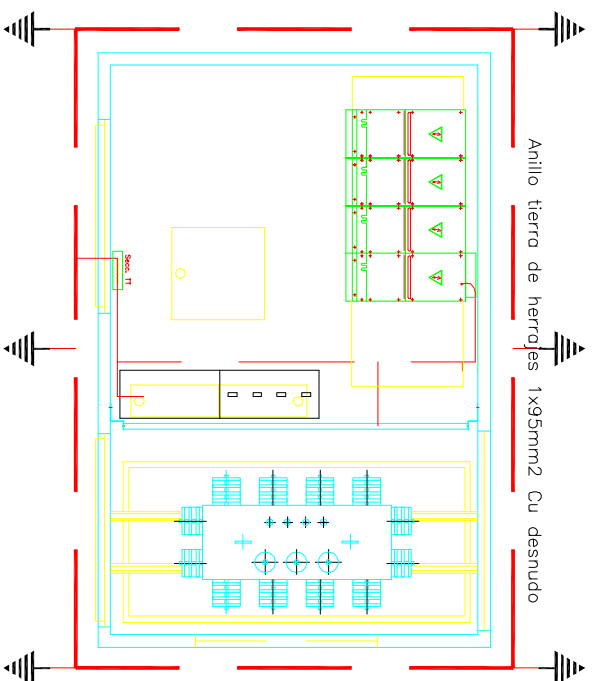

PLANTA

- 1- Placa de pinesos auxiliares
- 2- Far de quantific
- 3- Exhitor
- 4- Bancheta
- 5- Luminaria 2,38 W
- 6- Interruptor
- 7- Toma de corriente auxillar
- 8- Emergencia

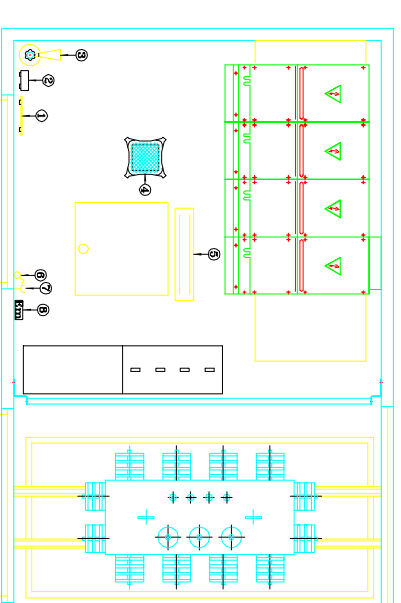

PLANTA

	PROMOTOR	DOMICILIO	C.I.F.	PLANO DE	PROYECTO	INGENIERO TECNICO INDUSTRIAL Lorena Pardo Fernandez
	UPCT	Piza del Cronista Isidoro Valverde (30/202) (Cartagena)	TEL. EFONO	instalacion, seguridad y red de tierras	ELECTRIFICACION DE POLIGONO RESIDENCIAL	
TITULAR FINAL	SITUACION INSTALACION	FECHA	MODIFICA.	PLANO		
IBERDROLA	Cartagena	09		9/4		
		EXPEDIENTE	ESCALA			
			S/E	A-3		

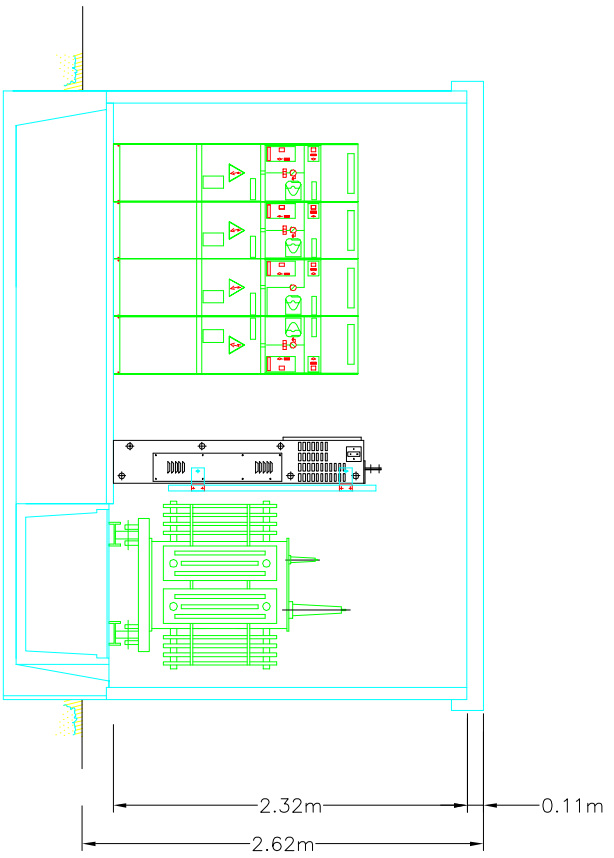

ALZADO

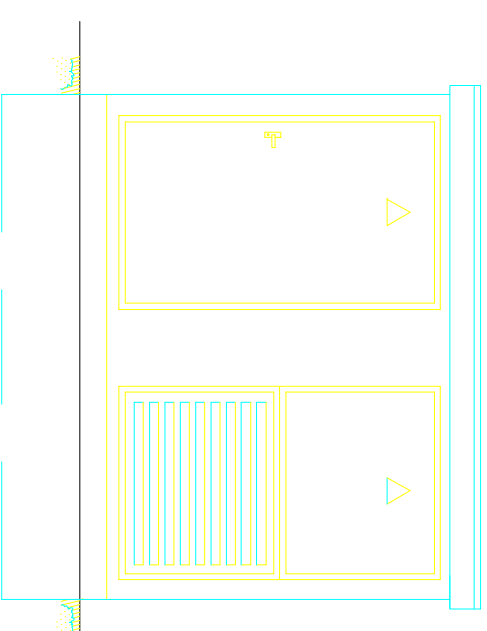

FACHADA

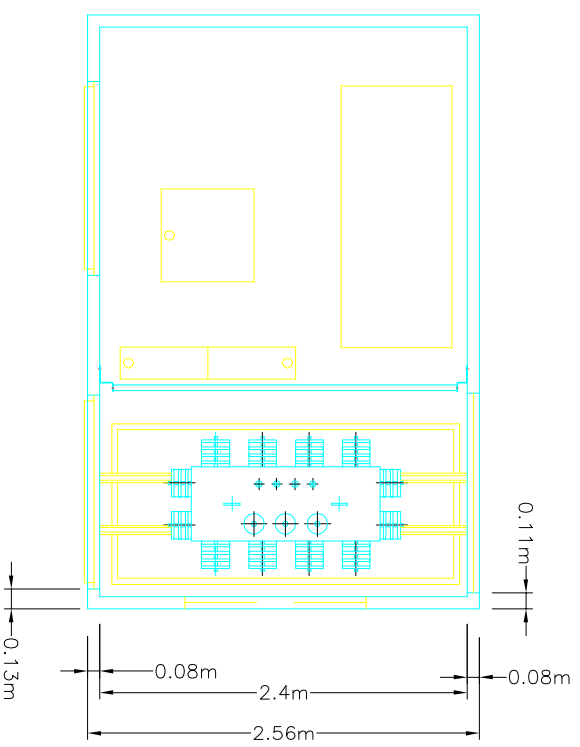

PLANTA

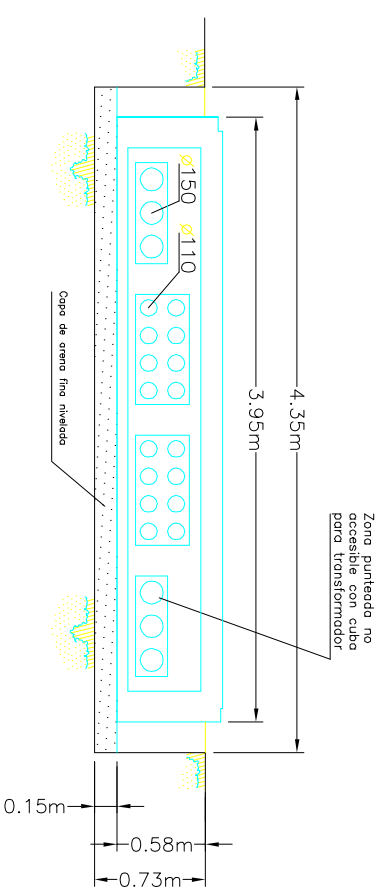



Lorena Pardo Fernandez

PROMOTOR	DOMICILIO	C.I.F.	PLANO DE	PROYECTO	INGENIERO TECNICO INDUSTRIAL
UPCT	Plza. del Cronista Isidoro Valverde (30/202) (Cartagena)	TEL.FONO	cotas	ELECTRIFICACIÓN DE POLIGONO RESIDENCIAL	
TITULAR FINAL	SITUACION INSTALACION	FECHA	MODIFICA.		
IBERDROLA	Cartagena	09 FEB			
		EXPEDIENTE	ESCALA	PLANO	
			S/E	9/5	

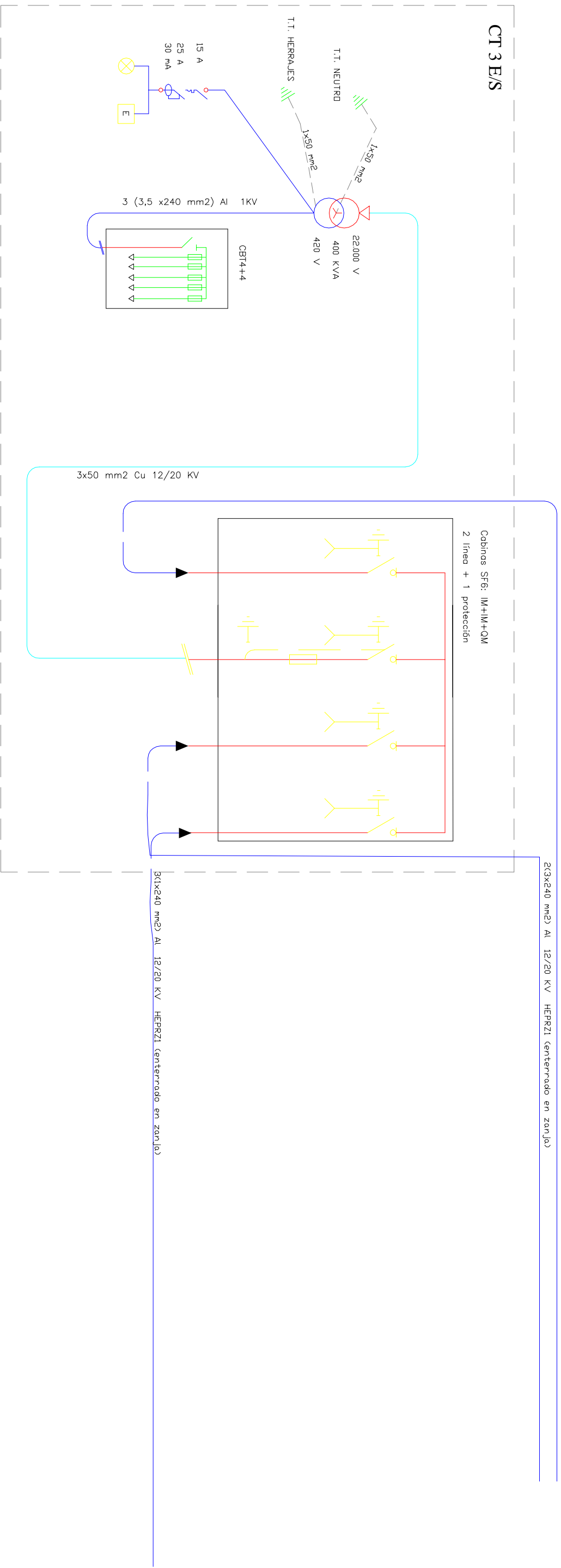
Lorena Pardo Fernandez



					
PROMOTOR	UPCT	DOMICILIO	Plza. del Cronista Isidoro Valverde (30/202) (Cartagena)		
TITULAR FINAL	IBERDROLA	SITUACION INSTALACION	Cartagena		
C.I.F.		PLANO DE	esquema eléctrico		
TEL. FONONO		ESCALA	A-3		
FECHA	FEB 09	PLANO	9/6		
MODIFICA.		PROYECTO	ELECTRIFICACION DE POLIGONO RESIDENCIAL		
EXPEDIENTE		INGENIERO TECNICO INDUSTRIAL	Lorena Pardo Fernandez		

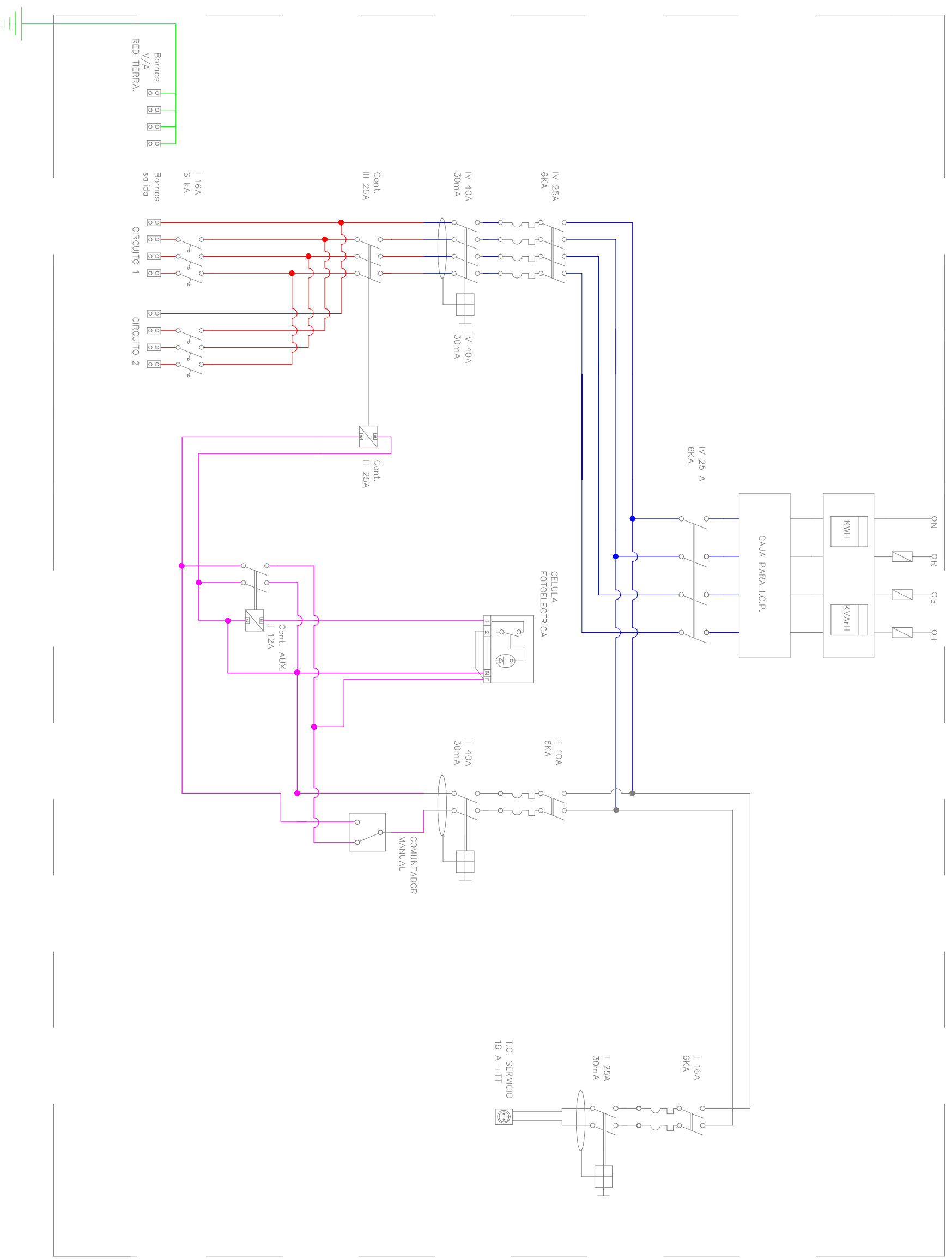

 Lorena Pardo Fernandez	PROMOTOR	UPCT	DOMICILIO	Pizza del Cronista Isidoro Valverde (30202)(Cartagena)	G.I.F.	PLANO DE	PROYECTO	INGENIERO TECNICO INDUSTRIAL
	TITULAR FINAL	IBBRDROLA	SITUACION INSTALACION	Cartagena	TELEFONO	ESQUEMA CUADRO DE MANDO	ELECTRIFICACION DE POLIGONO RESIDENCIAL	
		FECHA	09	MODIFICA	ESCALA	S/E	PLANO	
		EXPEDIENTE					11	