



Escuela Técnica  
Superior  
de Ingeniería de  
Caminos y Puertos  
y de Ingeniería  
de Minas

Escuela de Ingeniería de Caminos, Canales y  
Puertos y de Ingeniería de Minas



## **CIVIL ENGINEERING BACHELOR DEGREE**

*Analysis of urban plot of Lorca after the earthquake (2011): the effects  
of damages and urbanistic and geotechnical adjustment of the city.*

### **FINAL BACHELOR DEGREE PROJECT**

**Alexey Pudovkin Lazchenko**



Universidad  
Politécnica  
de Cartagena



Universidad  
Politécnica  
de Cartagena

*Under the guidance of:* Dr. Salvador García-Ayllón Veintimilla  
PhD Architecture and Civil Engineer  
Responsible for the Planning Unit of Infrastructures and Territorial Policy  
Cartagena, June 2018



Universidad  
Politécnica  
de Cartagena

Campus  
de Excelencia  
Internacional

Escuela de Ingeniería de Caminos, Canales y  
Puertos y de Ingeniería de Minas



## **GRADO EN INGENIERÍA CIVIL**

Análisis de la trama urbana de Lorca tras el terremoto de 2011: interacción  
entre daños y la configuración urbanística y geotécnica de la ciudad.

---

### **PROYECTO FIN DE GRADO**

**Alexey Pudovkin Lazchenko**

*Dirigido por:* Dr. Salvador García-Ayllón Veintimilla  
Dr. Arquitecto e Ingeniero de Caminos, Canales y Puertos  
Responsable de la UD de Planificación de Infraestructuras y Política Territorial  
Cartagena, junio 2018





Universidad  
Politécnica  
de Cartagena

Campus  
de Excelencia  
Internacional

Escuela de Ingeniería de Caminos, Canales y  
Puertos y de Ingeniería de Minas



## **CIVIL ENGINEERING BACHELOR DEGREE**

Analysis of urban plot of Lorca after the earthquake (2011): the effects  
of damages and urbanistic and geotechnical adjustment of the city.

---

### **FINAL BACHELOR DEGREE PROJECT**

**Alexey Pudovkin Lazchenko**

*Under the guidance of:* Dr. Salvador García-Ayllón Veintimilla  
PhD Architecture and Civil Engineer  
Responsible for the Planning Unit of Infrastructures and Territorial Policy  
Cartagena, June 2018

# INDEX

## 1. Summary

---

1.1 Abstract	9
1.2 Introduction	11
1.3 Historical facts	
<i>Earthquake of 1579</i>	16
<i>Earthquake of 1818</i>	18
<i>Earthquake of 1674</i>	20
<i>Tectonic frame</i>	26
<i>Seismic risk assessment in the region of Murcia</i>	30
<i>Geology of the epicentral zone: geological source of the earthquake</i>	37
<i>Implications of the earthquake of Lorca in the seismic danger</i>	38
<i>Analysis of the geological source of the earthquake: FAM</i>	39
1.4 Building damages and affected areas	43
<i>Damage to cultural heritage</i>	48
1.5 Detected pathologies relation	
<i>Interaction of structure and infill panel</i>	50
<i>Failure of the beam-column junction</i>	50
<i>Failure of the column and the infill panel</i>	52
<i>Failure of the non-structural masonry walls</i>	52
<i>Column failure</i>	53
<i>Shear failure of the infill panel</i>	55
1.6 Guide parameters	56

## 2. General information drawings

---

<i>The Seismoresistant Construction Regulations NCSE-02</i>	58
<i>Macroseismicity map of the eastern Betics</i>	59
<i>Map of the trace of the FAM</i>	60
<i>Lorca region</i>	61





<i>Soil classification and general structure</i> _____	62
<i>Affected districts</i> _____	64
<i>Public and historical building affected by the earthquake</i> _____	65

### **3. Analysis**

---

3.1 New evaluation techniques for information and aftershock management___	68
3.2 The territorial management perspective in the analysis of the seismic vulnerability of cities_____	71

### **4. Conclusions and future performances**

---

Seismicity_____	75
-----------------	----

### **R**

---

References_____	78
-----------------	----

### **B**

---

Bibliography_____	79
-------------------	----

### **Attached documents**

---

<i>Ley 7/2012, de 20 de julio, reguladora de la reedificación por sustitución forzosa para la urgente reconstrucción de Lorca</i> _____	80
---	----

## **Acknowledgments**

First, foremost, and most importantly, none of this could have happened without my parents, my life-coaches, Mikhail and Tatiana, who offered their encouragement through phone calls and discussions every week – despite my own limited devotion to correspondence. With his own brand of humor, my brother Dimitri has been kind and supportive to me over the last years. To all three of them – it would be an understatement to say that, as a family, we have experienced some ups and downs in the past years. Every time I was ready to quit, you did not let me and I am forever grateful. This dissertation stands as a testament to your unconditional love and encouragement.

*[Во-первых, прежде всего, и самое главное, ничего из этого не могло бы произойти без моих родителей, моих помощников и советчиков по жизни, Михаила и Татьяны, которые каждую неделю предлагали свою поддержку через телефонные звонки и обсуждения, несмотря на мою ограниченную возможность к общению. Со своим неповторимым юмором мой брат Дмитрий, был и остаётся доброй и надёжной опорой для меня в течение последних лет. Наша семья пережила как взлеты так и падения за последние годы. Каждый раз, когда я собирался сдать, вы не позволили мне этому, и я всегда благодарен. Эта диссертация является свидетельством вашей безграничной любви и большой поддержки.]*

I have to thank my research supervisor, Dr Salvador García-Ayllón Veintimilla. Without his assistance and dedicated involvement in every step throughout the process, this paper would have never been accomplished. I would like to thank you very much for your support and understanding over this past year. For any faults I take full responsibility.

I am so grateful to the Universidad Politécnica de Cartagena and the Faculty of Civil Engineering for making it possible for me to study here. I give deep thanks to all the Professors and lecturers that I have had a pleasure to meet and learn from.

Getting through my dissertation required more than academic support, and I have many, many people to thank for listening to and, at times, having to tolerate me over the past years. I cannot begin to express my gratitude and appreciation for their friendship. Carlos, Jose Ángel, La Chusa, El Patata have been unwavering in their personal and academic support during the time I spent at the University. For many memorable evenings, nights and mornings out and in, I must thank everyone above as well as Fernando and Perelló. I would also like to thank Jere and Pacow who opened both their home and heart to me when I first arrived in the city.





## ***Agradecimientos***

En primer lugar, y lo más importante, nada de esto podría haber sucedido sin mis padres, mis entrenadores de vida, Mikhail y Tatiana, quienes ofrecieron su incondicional apoyo a través de llamadas telefónicas y conversaciones todas las semanas, a pesar de mi limitada predisposición a la correspondencia. Con su propio estilo de humor, mi hermano Dimitri ha sido amable y me ha apoyado en los últimos años. A los tres, sería una exageración decir que, como familia, hemos experimentado algunos altibajos en los últimos años. Cada vez que yo estaba a punto de rendirme, no me dejasteis y estaré eternamente agradecido. Este Proyecto Fin de Grado se erige como un testimonio de vuestro amor incondicional y apoyo.

Tengo que agradecer a mi tutor y supervisor, Dr. Salvador García-Ayllón Veintimilla. Sin su ayuda personalizada y dedicación exclusiva en cada paso del proceso, este documento nunca se hubiera logrado. Me gustaría agradecerle mucho su apoyo y comprensión durante este año pasado. Por cualquier falla, asumo toda la responsabilidad.

Estoy muy agradecido a la Universidad Politécnica de Cartagena y la Escuela de Ingeniería de Caminos, Canales y Puertos y de Ingeniería de Minas por haberme permitido estudiar aquí. Doy las gracias profundamente a todos los profesores y personal docente que he tenido el placer de conocer y aprender.

Superar mi Proyecto fin de Grado requirió más que apoyo académico, y tengo que agradecer a muchas personas por escucharme y, a veces, tener que tolerarme en los últimos años. No puedo comenzar a expresar mi gratitud y aprecio por vuestra amistad: Carlos, José Ángel, La Chusa, El Patata han sido inquebrantables en su apoyo personal y académico durante el tiempo que pasé en la Universidad. Por muchas noches y días memorables, debo agradecer a todos los presentes, así como a Fernando y Perelló. También me gustaría dar las gracias a Jere y Pacow que me abrieron su hogar y su corazón cuando llegué a la ciudad.



# 1. Summary





## 1.1. Abstract

The Lorca earthquake of May 11, 2011, is the most important event that has affected the Spanish mainland in the last 55 years, since the earthquake of *Albolote, Granada*, in 1956 which, interestingly, was the same type and had the same magnitude of 5,1 degrees on the Richter scale.

In these more than 60 years, the typology of the buildings has changed completely, from buildings of masonry walls up to two storeys high, the generalization of apartment buildings from an average of 6 floors, columns and beams with rigid joints and concrete floors. It is important to make constructive behavioural experiences that have buildings Lorca, it is the only real case we have, for the improvement of seismic structural safety of buildings in Spain.

Lorca has been found in the bad behaviour of the brick structures with which it is built heritage. It has been proved that with the exception of a building, the new structures of concrete and steel seismic acceleration has exceeded three times the standard prescribed by seismic NCSE-02, which were calculated. By contrast, there has been the worst performance of the factory elements (bibs, fences, walls, brick, etc.) with widespread failures, which are those that produced the enormous damage to housing and personal injury. These elements are not «structural» but the NCSE-02 standard set for them conditions that have not implemented in buildings constructed since the adoption of this standard.

The earthquake in the *Cordillera Bética* of SE Spain occurred almost exactly on the *Alhama de Murcia* fault (FAM), a marked fault that forms part of a NESW trending belt of faults and thrusts. The fault belt is reminiscent of a strike-slip corridor, but recent structural studies have provided clear evidence for reverse motions on these faults. Focal mechanisms of the main earthquake, but also of a foreshock, are strikingly consistent with structural observations on the *Alhama de Murcia* fault. This strengthens the conclusion that, rather than a strike-slip fault, the fault is at present a contraction fault with an oblique reverse sense of motion, presumably in response to the NW-directed motion of Africa with respect to Europe.

Archive documents provide the main source of information concerning historic earthquakes, their chronology and global effects when they occurred before the instrumental period. Nevertheless, exhaustive consultations of documents and detailed studies of them have hardly ever been undertaken. The recent earthquakes at Lorca have stimulated an effort to transcribe all the documents dealing with seismic events in the region and also to analyse in depth the wealth of files regarding the 1674 Lorca earthquake, with the aim of fully characterizing its effects. The register of damage appraisal has allowed me to draw up graphics and tables showing the magnitude of the natural disaster: 1,683 buildings were inspected, of which 1,178 were damaged, 479 were devastated, and 26 suffered no harm. According to the type of building involved, 97 percent belonged to housing, 2 percent to urban infrastructures, and 1 percent to religious buildings. It is also offered guidelines to the kind of local documents offering

information on these events together with suggestions as to how to find complementary information in other archives within the Spanish system.

**Keywords:** *Risk management, risk assessment, seismic risk, seismic vulnerability, masonry structures, damage assessment, Lorca historic centre, collapse mechanisms, pathology, heritage, construction, structural safety, earthquake, Lorca.*



## 1.2. Introduction

The base of the seismic hazard studies to mitigate future earthquake losses is to understand the earthquakes that hit a region in the past. Seismic catalogues incorporate information about past events by palaeoseismological, archaeological and historical studies. A multidisciplinary combination of historical, archaeological and palaeoseismological data can provide insight into the seismogenic fault, recurrence, location and socioeconomic effects. The study of the seismogenic fault by palaeoseismological studies of the surface rupture is one of the data sources (on-fault) that provide estimation of fault rupture, magnitude, location and recurrences for seismic catalogs. Unfortunately, catastrophic earthquakes of low to moderate magnitudes ( $M < 6.5$ ) may not leave evidence of the surface ruptures. Therefore, for earthquakes for which seismogenic fault and surface ruptures have not been identified (because of the low to moderate magnitudes, blind faults, or just because it is not observed at the surface due to subsequent burial, erosion by surface processes or destruction by human activity), the evidence of the seismic events is found in the earthquake damage (ED) observed in historical or archaeological sites. Earthquake information can be obtained by the study off-fault of the ED recorded in historical and archaeological sites or in historical photographs and descriptions of the earthquakes (archaeoseismology, historical seismology) [14]. This information, along with how the population felt the earthquake in many cases has been used to make estimations of the earthquake dates, locations of epicentres, focal depths, magnitude or intensity, ground shaking and seismic moments of the seismic events [14]. All this information is crucial to evaluate the seismic hazard and regulatory seismic codes [14].

In addition, as a consequence of the accident at the Fukushima Daiichi nuclear power plant (11th March 2011) and the lessons learned from that experience, the International Atomic Energy Agency (IAEA) undertook re-evaluation procedures for nuclear power plants and one of its strong recommendations is the use of ancient earthquakes data in seismic hazard assessments (IAEA, 2015).

Damage in architectonic elements of buildings are one of the effects observed after earthquakes, and they can remain in historical buildings and archaeological sites for years and even centuries as a witness of the earthquake. Such earthquake damage can be used to complete historical seismic catalogues and give information about earthquake parameters [14]. The orientation of the earthquake damage (e.g., fallen columns, toppled walls, conjugate fracture sets in walls, or dropped keystones in arches) in architectonic elements suffered due to an earthquake can be regarded as a structural seismoscope of the ground motion pulse [14]. For example, the generation of a dropped keystone requires horizontal ground motion. In addition, from early studies like Mallet's reports in the 19th century, observations of the orientations of fractures in walls and of tilted and collapsed walls were used to infer the epicentres and depths of the earthquakes. This information is especially important for earthquakes where non-instrumental information (e.g. seismometer information) is available (historical or archaeoseismological earthquakes).

Commonly in historical and archaeoseismological studies the systematic orientation pattern of fallen columns and the tilting of architectural elements, at archaeological sites and historical buildings hit by earthquakes has been used to constrain seismic parameters like the epicentre location, the orientation of the P-waves, the orientation of the compressional strain and the kinematic of the fault [14]. However, the parameters that are obtained from this orientation are contradictories between different authors. Thus, traditionally the earthquake damage orientation is interpreted as the orientation toward the epicentre and the P-waves. Other authors propose that a systematic orientation of damage effects at a site indicates the direction of maximum-shortening and the orientation of seismo-tectonic strain ellipsoid [15]. Others suggest that fallen columns oriented in the same direction indicate the kinematics of the fault [16]. Recently, others authors even question these relations [17] because other factors like geometry, topography or irregularities in the columns could affect the fallen orientation and therefore is not clear the relation of falling directions to earthquake source location.

The catastrophic earthquakes of Lorca 2011 caused significant destruction of historical heritage (e.g., castles, churches, aqueducts, monumental monoliths, etc.). It also generated significant economic losses and fatalities, although the magnitudes of these earthquakes were moderate or low (never exceeded M 6.5, with no surface rupture). These earthquakes have allowed the systematic measurement a large number and wide variety of ED in historical buildings (the same structures used in historical and archaeological studies) and also a comparison of their orientations (Earthquake Orientation Damage-EDO) with modern instrumental data which is not possible in historical and archaeoseismological studies (seismogenic fault trend, focal mechanisms, accurate epicentre locations, magnitudes, etc.).

Lorca is an ancient city located within a moderated seismic region in southeast of Spain. It is characterized by a very rich historic heritage including not only monumental or religious buildings (towers, mansions, palaces, churches or monasteries) but also a residential stock varied in age and styles.

Its seismic activity has been documented from historical sources since 343 b.C. and from instrumental sources since 1920 (IGN 2012), being the most important earthquakes in 1579, 1674, 1818, 1911, 1948, 1999, 2002 and 2005. The occurrence of the last earthquakes increased the seismic hazard and seismic risk studies of the area [18]. Within this context the RISMUR project (Seismic Risk Assessment of the Murcia Region) was led and financed by the national and local government. Its final report [19] considered Lorca one of the cities within the Murcia Region with higher seismic risk, due mainly to its proximity to the active *Alhama de Murcia* fault, providing recommendations for future developments in order to define risk reduction measures.

As many of the European historic centres in seismic active areas, Lorca's city centre consists of a residential and commercial district with a majority of the buildings made of unreinforced stone or brick masonry, often with a bad level of maintenance. Despite of the Special Protection and Rehabilitation Plan of the Historic and Artistic Site of Lorca, PEPRI, (Lorca's City Council 2000), some of the buildings have been allowed to decay. On the other hand, there hasn't been any explicit concern to earthquake protection in this area: except for the use of ring beams, quoins or iron ties in a small





number of buildings, there has been hardly any upgrading intervention to improve their seismic vulnerability.

On 11 May 2011, exactly 2 months after the Fukushima disaster in Japan, a two-shock earthquake struck the city of Lorca, located about 60 km southwest of Murcia in southern Spain. The earthquake mainly affected the city centre, home to 60 000 of the municipality's 90 000 inhabitants (Fig. 1). The Lorca earthquake was not one of the deadliest in the Mediterranean area but did display several novel features.

The Iberian Peninsula had not experienced such a deadly earthquake since 1956, when an earthquake killed 13 people in southeast Spain, near the city of Granada. In 2011, the magnitude Mw 5.2 Lorca earthquake occurred at around 18.47 h local time (16.47 h GMT), after another magnitude Mw 4.6 foreshock had occurred almost 2 h before. With an epicentre intensity of VII (EMS-98), the quake killed 9 people and injured 300. One building collapsed completely and 1164 others were severely damaged. Economic losses were estimated by Lorca municipality at EUR 1 200 million in November 2011. The casualties were caused in streets near buildings and were due not to collapsing buildings but to falling cornices, balconies and other façade elements [20].

The shock lasted only a few seconds, developing a maximum acceleration of 0.37 g, as recorded in the city 3 km from the epicentre. It was the highest acceleration recorded in Spain since the first accelerometers were installed in the region in 1984. Site effects, shallow focal depth, high acceleration and the relatively high vulnerability of infrastructure seem to be the main factors explaining the damage. They probably helped restrict damage to the city itself, as there was hardly any visible damage only a few kilometres outside the city limits. The nearest outside measuring station, located 24 km from the epicentre, actually recorded a peak acceleration of only 0.02 g, nearly 20 times less than that recorded inside the city.

Finding references to documents concerning the geological characterization and behaviour of the notorious *Alhama Murcia* fault and some of its most recent earthquakes is relatively easy because of their abundance. Nevertheless, data from the municipal archives about the seismic history of this area which might be related to this fault are rarely researched. Seismologists have in general focused their interest on the secular calendar dates, intensities and magnitudes of the most significant earthquakes that can be studied from documents in the municipal archives.

In many cases the information is difficult to arrive at and incomplete because of problems with understanding the palaeography. There are also other factors that have an influence on the limited use of historical archives: I hardly ever have complete and expressive enough documentation to allow anything like an “Xray” view of earthquake effects. The minute books of the municipalities where earthquakes have taken place were the first to report the event. Generally, a few days after an earthquake, municipalities adopted agreements to remedy the disaster effects. These agreements contain a concise account of the facts in some detail and thus allow me to obtain some idea of the involvement of the population in the event. The agreements also talk about the decisions that have been made to lend aid to the scene of the disaster, namely to ensure basic supplies of food and water, to restore essential services and so on.

In severe cases it was usual to provide higher authorities with detailed information. It was possible in fact find letters addressed to the king and various government institutions describing what had happened. In some cases the letters provide assessments of damages and plead for exemption from payments and taxes so as to alleviate the precarious conditions in which a city was plunged after such events. These requests may be coupled with a reply, such as the provisions of the king, who communicated to the council the granting of exemptions or non-payment of tax dues in subsequent years. The provisions of the king also granted special taxes collected directly from other councils to enable the reconstruction of the city. There are also papers that report on the overall economic damage as well as religious events organised to quell what was considered to be “a manifestation of the wrath of God”.

Records of historic seismicity in Lorca recount nine events, in the years 1579, 1674, 1713, 1755, 1783, 1792, 1818, 1862 and 1890. Only three of them were of an intensity of more than V and led to substantial damage. The most complete documentation on historic earthquakes preserved in the Lorca municipal archives relates to the seismic sequence that took place in August 1674. Earth tremors began on August 9 and continued over the next two months. On August 29 the acting mayor, *Juan de Alburquerque Leones y Guevara*, and nine councillors met in the main square in Lorca to announce providences concerning the first religious acts. Once the urgencies of casualties had been solved the council members were more concerned about the religious acts of “relief” and “atonement” than pressing issues of public policy. On August 31 eight working teams were formed, each led by an alderman and subject to the advice of a master builder, to assess damage and the demolition of ruined buildings. One of the groups was commissioned to review the clock tower and repair the water pipe in the square. Six groups would be responsible for the higher parishes, *San Pedro*, *Santa María* and *San Juan*, and two of the most populous parishes, *San Mateo* and *Santiago*. Lastly, the eighth group would be responsible for the neighbourhood located on the other side of the river, *San Cristóbal*.

On the same day an agreement was adopted to take water to the mills and to repair the ovens to bake bread. Bakers were also ordered to be found to ensure that there were no interruption to the public supply of bread. On November 10 a request was made to the king to write off the city’s overdue debts to the royal treasury. A similar request was made to be exempted from the tax burdens of the kingdom as well as the city’s being allowed means to undertake public reconstruction works.

The document recording the damage assessment caused by the earthquake in August 1674 is preserved in the Lorca municipal archives. It is made up of 60 sheets and contains a detailed account of all the buildings that had been damaged or devastated. More than 1,600 buildings were affected. Experts used three terms to classify the affected buildings. Those terms were “no harm”, “damaged” and “devastated”.

First of all, the damage assessment document was fully transcribed and I then proceeded to extract the information. All the buildings were classified into three different types. In this way, it was possible to find homes, religious buildings and urban infrastructures (prison, towers and walls, gates, fountains, clock, slaughterhouse and butcher’s shop, granary, etc.). The appraisal of homes has special characteristics because there were some houses which were overvalued, such as some of those located in *Santiago* and *San*



*Mateo*, neighbourhoods where the local nobility built their mansions emblazoned with their coats of arms. This type of house has been omitted from the calculations of the average housing assessment so as to avoid any distortion of the final result. The average price of devastated homes was estimated. The building was considered to be devastated if it was affected to the extent of more than 50 percent. Half of the average price of homes was calculated. The resulting data were chosen as the maximum limit of appraisal. Any data greater than this limit were not included in the calculation of the average damage to homes. The results were related to the average price in order to ascertain the average percentage of damage.

In Lorca, casualties mainly occurred outdoors (outside the buildings), whereas they are usually found under the ruins of damaged buildings. Hence, I focus on the individuals' exposure over the time, along the main public areas. Following other recent studies, I chose to adapt the most common approach that primarily examines structural defects caused by earthquakes and how these can cause casualties [21].

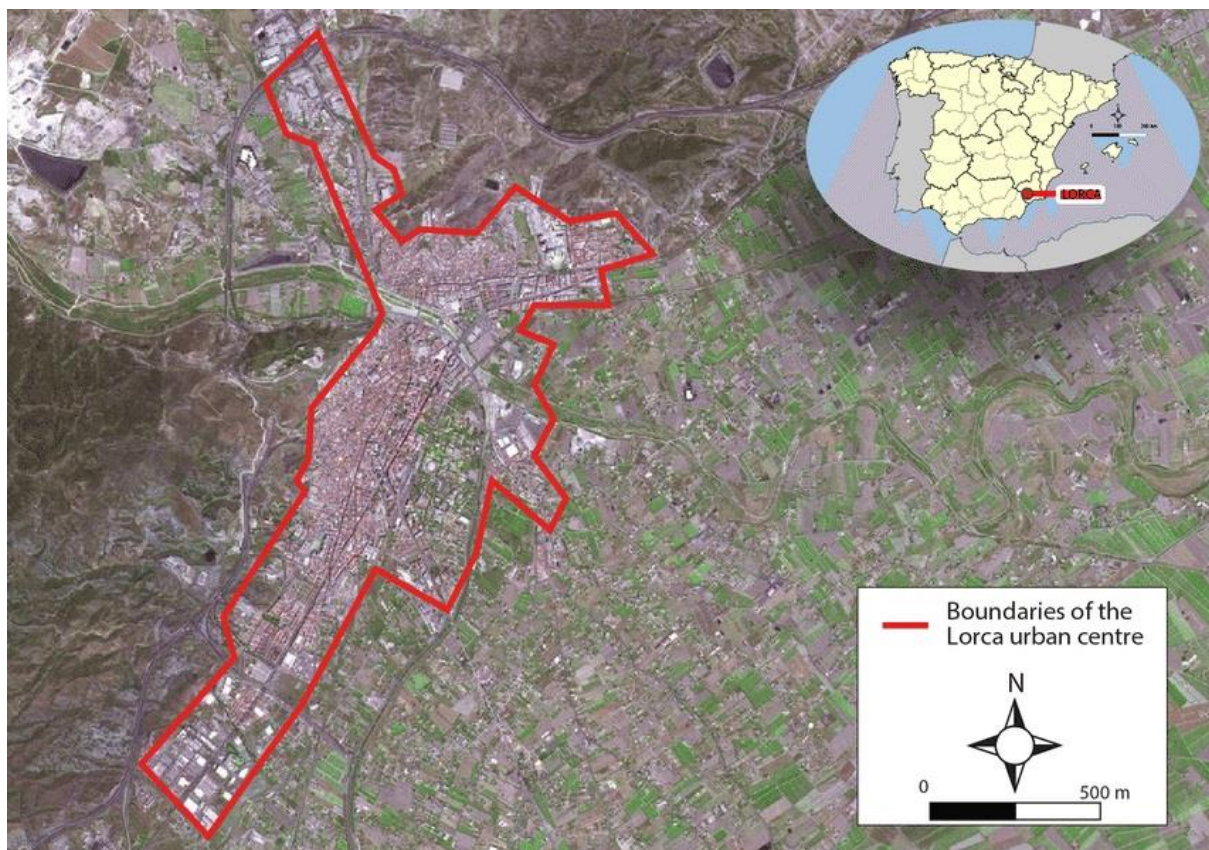

Figure 1. Location of Lorca (inset) and view of the city centre. SPOT source courtesy of the ©Instituto Geográfico Nacional de España.



## 1.3. Historical facts

### *Earthquake of 1579*

The first known earthquake occurred on January 31, 1579, and it is known from the chapter minutes of Tuesday, February 3, the following:

*“Este dicho día se juntaron a Concejo en la sacristía de la iglesia colegial de San Patricio de esta dicha ciudad atento que por haber sido nuestro señor servido de enviar a esta ciudad temblores de tierra que han sido causa que la sala del ayuntamiento donde esta ciudad se acostumbra a juntar esté muy consentida y dañada y con muchos peligros...”*

At the request of the four and a half million “*maravedies*” that the city had to contribute as a result of the taxes that had been given to it, the Council responded in the same session:

*“Los dichos señores Lorca dijeron que por cuanto esta ciudad está encabezada en cuatro cuentos y quinientos mil maravedíes pagaderos a su majestad y a los señores sus contadores mayores, por estar la tierra y término de ella y de su jurisdicción muy pobres y alcanzados de causa de la esterilidad que de siete años a esta parte ha habido y no se puede pagar el dicho encabezamiento y los vecinos de la ciudad cada día molestados por la cobranza de las dichas alcabalas dejan sus casas y se van a poblar y comer a otros pueblos como es notorio faltar de presente mucho número de vecinos de ella y porque el sábado pasado último de enero por causa de los terremotos y temblores de tierra que antes y después ha habido otros muchos vecinos de esta ciudad se han salido de ella y cada día se salen y van con sus casas y haciendas a otras partes especialmente a los lugares del Reino de Granada por particulares provisiones y pragmáticas de estos reinos los que los pueblan son exentos de pagar pechos y alcabalas y otros derechos a su majestad pertenecientes y para que a su majestad conste de la dicha esterilidad y de los dichos terremotos y de cómo esta ciudad se despuebla y cada día se despoblará más por haber quedado las casas y edificios de ella muy a peligro y arruinados y muchas de ellas caídas y para reparo de los dichos edificios y poder vivir y habitar en ellos se habrán de gastar más de treinta mil ducados y la gente y vecinos de esta ciudad por estar las casas y edificios como dicho es se salen y han salido a vivir y viven en las huertas y campos de esta ciudad. Mandaron que se haga información de todo lo susodicho...”*

In spite of the preventions of the “*regidores*” meeting in a building of greater solidity for being constructed entirely with ashlar, they returned to their habitual seat a few days after, although occupying provisionally, and during a month, more or less, the tower that was attached to room. It can be estimated, therefore, that the damages were not as alarming as it might be expected from the first statements, although there is no way in knowing the content and the evaluations of the reports that were undoubtedly





sent to the Court. From the available and scarce information, we can point out that there were a series of earthquakes that preceded and succeeded the main one, whose greater intensity is estimated in VI-VII; that there were no irreparable personal injuries, or at least they were not made explicit; that the material damages in the buildings were considerable for the 30,000 ducats in which they were evaluated - a very high amount of money - although it seems that it was a general cracking of the constructions of worse quality; and that the most modest part of the hamlet could be the most affected, even experiencing some collapse. The letter that the “*corregidor murciano*”, Jorge Manrique, wrote to Lorca on February 5:

*“Yo he sentido en el alma la desgracia que por esa ciudad ha venido y si fuera alguna parte para el remedio de ella a la hora me partiera para allá pero son cosas de la mano de dios y para que acuda con su misericordia es bien que vuestras mercedes ordenen se hagan algunas procesiones solemnes procurando en ellas muy buena orden y concierto, con lo cual y buena conformidad espero en dios aplacara su ira; y de la poca que estos días pasados ha habido entre Vuestras mercedes estoy yo con harto cuidado y con brevedad iré a esa ciudad a dar orden en las cosas que se ofrecieren. Aunque estoy satisfecho que vuestras mercedes tienen cuidado de hacer castigar los pecados públicos y ruin vida de algunas gentes, quiero traérselo a la memoria, y así mismo escribo al alcalde mayor porque muchas veces los trabajos y calamidades envía Nuestro señor por causa de esto...”*

The misfortune of the neighbours was reflected again in another letter addressed to the king by the city, on April 7, 1579, revealing

*“... la extrema necesidad en que está, que la tiene imposibilitada para poder cumplir con el precio de su encabezamiento. Por lo cual y los grandes terremotos que en este presente año ha habido en esta ciudad han necesitado tanto a los vecinos a que para el reparo de sus casas gasten mucha parte de sus haciendas como más en particular por la información que de ello tenemos hecha y presentada ante los del consejo de hacienda de vuestra majestad ...”.*

It is clear, again, that the series of earthquakes was intense and from everything that happened, perhaps, there might be a way to recover the report that was sent to the royal estate which would help to make a more accurate assessment of the effects that actually caused the earthquakes.

## ***Earthquake of 1818***

The earthquake of 1818, which have caused damages very similar to those experienced in the sixteenth century, is inserted in a series that reached its peak on December 19 and 20. That first day, at four in the afternoon, a premonitory movement took place, and it was at a quarter to ten the next day when an earthquake of intensity VI-VII produced a general damage throughout Lorca. The current dean, José Gómez Manzanera, is the one who seems to take charge immediately of the situation in the absence of the “*corregidor*”. He has ordered to the masters “*alarifes*” to go and to recognise the damaged buildings and to the medical and surgery doctors to help the wounded. This was his disposition:

*“...dijo: que habiéndose sentido un terremoto extraordinario a la diez menos cuarto de la mañana de este día y difundido la voz de que se han resentido varios edificios y causado algunas desgracias: lo que es de creer por su fuerte impulso y ruido estrepitoso que se ha oído; debía de mandar y mandó que para indagar los estragos que ha causado y proveer del oportuno remedio, se haga saber a los maestros veedores del gremio de Alarifes que por sí y por todos los maestros procedan a reconocer todos los edificios de esta población y a poner un estado demostrativo de los quebrantos que hayan padecido principalmente con respeto a los que puedan amenazar ruina; y que se pase oficio a la facultad médica y al subdelegado de la superior junta de cirugía a fin de que cada cual por su parte pase una noticia exacta de los heridos que hayan curado y personas a que hayan asistido y socorrido a resultas de dicho terremoto. Publíquese bando para que todos los vecinos a quien haya tocado alguna desgracia concurran a las respectivas facultades de medicina y cirugía para que les asistan y curen; y a su maestro todo aquel que advierta quebrantamiento en su edificio y conceptúe ser de pronta necesidad su reparación; y sin perjuicio de todo póngase este acontecimiento en la consideración del Real y supremo consejo por conducto del señor don Bartolomé Muñoz para las disposiciones de su agrado...”*

After the notifications to the concern parts and after fulfilling the orders, on the 21st a quick report was made by Bartolomé Muñoz and on the 25th of that month the communications of the doctors were received quantifying in a bit more than a dozen the seriously wounded. The serious wounded were caused by bruises and blows, especially in the head and extremities, caused by the detachment of tiles and bricks falling from cornices, broken roofs and chimneys, by the collapse of walls and collapsed work pillars. Of all the damages, which were completed with the lists of affected buildings made by the mayors of the neighbourhood, a report was made -of which no copy is kept- and, according to the documentation in the file, was taken care of by the government. Some more information provides a letter addressed on March 6, 1819 to the jurisdictional rector of Lorca by the president of a room of the Chancery of Granada, which in the part that interests us says as follows:

*“...Enterada la Sala de la representación que dirigió Vuestra merced noticiando que la mañana del día veinte de diciembre se experimentó en esa ciudad un terrible temblor de tierra que quebrantó varios Templos y otros edificios*





*arruinando diferentes casas y que enseguida providenció que los facultativos de medicina y cirugía reconociesen los heridos y enfermos resultando hasta el día veintiséis haber de peligro de diez a doce y que también decretó el reconocimiento general del pueblo para evitar en lo posible los perjuicios que puedan ocurrir, y que en la madrugada de dicho día hubo otro sacudimiento que arruinó tres casas en la Parroquia de San Pedro en las que no sucedió desgracia por estar las familias fuera, ha mandado tome usted las providencias más activas para la asistencia y curación de los heridos dando cuenta de su resultado por mano del fiscal de Su Majestad del crimen don Lucas Gómez Negro...”*

There was then a reply of some consideration at dawn from 20 to 21, since it threw to the ground those three houses mentioned that possibly had been affected by the previous tremors.

As already mentioned, the property damage appraisal report is not kept, but the one that was compiled -in total 19 folios- to make a city vote to Santo Domingo de Silos, on which the earthquake occurred, for having "freed" the neighbours from suffering greater damages. It contains the translation of the agreement of the City Council, with the rhetorical intervention of the councillor Juan Jacinto Ferrer responsible for making the difficult claim in favour of recognition of the protection of the saint, the processing before the ecclesiastical authority to grant the party and preliminaries, after of one year, for the religious celebration. Of all the written, nothing provides new information about the earthquake suffered by the city.

## ***Earthquake of 1674***

The most complete documentation on historical earthquakes preserved in the Municipal Archive of Lorca is relative to those that took place in August 1674. Due to the general damage caused by the earthquakes, because it affected only the main population centre and due to the fact that it caused deaths and a large number of injuries, its comparison with those of May 2011 could not be stopped. The earthquakes of 1674 are the best documented series among the historical and the longest in time, having its most tragic staging on August 28 of that year.

Although there is no warning of the municipal agreements, the seismic movements felt by the population began on August 9 and would continue even in the following two months. For the moment, a few days after the tragedy happened, let's see in the words of the councilmen how the situation was:

“Señora

*La aflicción y desconsuelo con que esta ciudad se halla la obliga a tomar el alivio de dar aviso a Vuestra Majestad de su miseria y desdichas para que en tan gran trabajo les sea amparo la Real Conmiseración de las piadosas entrañas de Vuestra Majestad. El día 9 de agosto, víspera de San Lorenzo, a las 11 de la noche, acaeció un terremoto a esta ciudad tan grande y repentino con quebranto de algunas casas que la puso en confusión y alboroto, quedando los vecinos llenos de pavor con el accidente y se continuaron otros menores por algunos días hasta que el día de San Agustín, 28 de agosto, a las 9 y media de la noche, sobrevino uno tan grande y espantoso que destruyó la mayor parte de esta ciudad con muerte de más de 30 personas y muchos heridos que cogieron las paredes de las casas, siendo todas las quebrantadas y mucha parte totalmente destruidas y los templos y torres de ellos tan quebrantados y arruinados algunos que ha obligado a los curas sacar los santos sacramentos y ponerlos fuera de la ciudad, siendo forzoso dejar las monjas sus casas y habitar en barracas en la huerta del convento de Santa Clara donde están las de ambos conventos y entrar con temor y prisa en algunos templos que han quedado a decir misa - Privó del uso del Reloj el quebranto de su torre, de la cañería del agua de la fuente única publica de Lorca - Arriesgados los frutos cogidos y maltratados la mayor parte, mezclados con la tierra, otros que no pueden consistir por arriesgados de sacar e imposible de conservar - Las casas del Ayuntamiento tan cascadas que por el riesgo es necesario hacer los cabildos en el yermo - Y por escapar las ruinas todos han dejado la ciudad habitando bajo los árboles de la huerta, siendo espantoso espectáculo volver los ojos a los edificios como la noche del fracaso lo fue la confusión, los gemidos, el polvo y la sangre de los muertos y heridos; no es posible en largos años la reparación de esta ciudad y es el daño inestimable - Ayer domingo se sacó una procesión general que se compuso en esta plaza y salió por fuera de los muros presidiendo en ella el Arzobispo de Durazo que fue de particular consuelo a los vecinos su asistencia y prácticas que hizo, yendo todos descalzos, así los cabildos eclesiásticos y secular como todo lo restante del número que se componía y muchos al ejemplo del arzobispo*





*con sogas a la garganta y coronas de espinas y otras penitencias = Suplica esta ciudad a Vuestra Majestad sea servida de mandarla singularmente encomendar a nuestro señor y mirarla en todo con la acostumbrada piedad de Vuestra Majestad CC RR que guarde nuestro señor los muchos años que estos afligidos vasallos deseamos y hemos menester.*

*Lorca y septiembre 3 de 1674 años”*

The bleak picture that was painted to the regent queen, was no more than a light but accurate sketch of what had happened. The remoteness of the premonitory tremor, which was believed definitive since the aftershocks did not cease in later days, surprised the unsuspecting population and in their homes when the major earthquake struck. The large number of deaths and injuries was caused by the collapsing walls and roofs, with the collapse of the public infrastructure almost necessary. Once the harvests were harvested in cages and chambers, the crops were considered lost and the general destruction of buildings was irrecoverable. And although it may be thought that pessimism invaded this type of report, we must remember that an important part of the monumental features of the city, including churches, convents and large houses in the historic centre, would take the final form the one that deserved the declaration of Historical Set in 1964 - between the final decades of the XVII and the first of the XVIII.

On August 29,

*“en la plaza mayor de esta ciudad por defecto de estar muy maltratadas las casas de cabildo ocasionado del terremoto que sucedió en esta ciudad la noche del día veintiocho”*

at half past nine in the morning, the interim “*corregidor*”, Juan de Alburquerque Leonés and Guevara was “*alférez*” mayor- and nine “*regidores*” to dictate the first measures:

*“La ciudad dijo que por cuanto la noche del día veintiocho del corriente a hora de las nueve y media de ella, algo más o menos, sucedió en esta ciudad tan gran terremoto que destruyó y asoló totalmente mucha parte de las casas de esta ciudad y las demás muy destruidas sin haber reservado iglesias, torres y otros edificios fuertes y todavía se van continuando dichos terremotos y con el primero está la gente tan escandalizada de ver la compasión de los muertos y heridos, ruinas de casas y haciendas y por continuarse dichos terremotos van despoblando la ciudad y hacen barracas para su habitación y para el consuelo de los vecinos conviene se hagan rogativas y procesiones rogando a su divina majestad sea servido de aplacar su ira. Por tanto se acordó se dé recado de parte de esta ciudad a los señores abad y cabildo de la colegial de ella para que se sirvan de hacer rogativas y el domingo siguiente se haga procesión general penitente a San Lázaro, a Ntra. Señora de los Remedios, y el señor vicario para que lo dé a los señores curas. Y así mismo a los conventos para que hagan dichas rogativas y así mismo se dé recado al Ilustrísimo señor arzobispo obispo de Durazo que al presente se halla en esta ciudad para que se sirva de asistir a la procesión y se publique que todos los fieles cristianos confiesen y comulguen.”*

It is discouraging to see that in the first moments, save the urgencies of the dead and wounded, the “*regidores*” were more concerned about the religious acts of "reparation"

and "expiation" than for pressing matters of public order. Until the 31st of that month they did not meet again and then they began to see clearly: the hermitage designated for the procession was among rocks that had fallen and, as a precaution, a general demonstration of penance was ordered in the Hermitage of "Nuestra Señora de Gracia", located on the plain, next to the road to Andalusia. It was also ordered that an altar be installed in the main square to celebrate masses and that the faithful who wanted to pray without the fear of entering the temples. And, finally, more sensible agreements were adopted:

*“La ciudad dijo que por cuanto con el terremoto de la noche del día veintiocho del presente se han hundido tantas casas que no se puede andar por las calles así por la mucha cantidad de piedra y tierra que hay en ellas como por el temor de que hay muchas que están amenazando ruina de instante a instante, se caen muchos pedazos que atemoriza y está a pique de que sucedan muchas desgracias y muertes, y para obviar los dichos inconvenientes acordó que los maestros de albañilería de esta ciudad reconozcan todas las casas de esta ciudad y todas las que tuvieren peligro las derriben y cada uno vaya con un caballero regidor de este ayuntamiento y así se decretó...”*

Consequence of that decree was the organisation of up to eight gangs, each headed by an alderman who had the advice of a master builder, to assess damage and demolish those buildings that were clearly ruined. "Regidor" Gaspar de Pareja, with the company of the masons Martínez Botija and Antonio Rodríguez, was entrusted with the task of checking the clock tower and repairing the water pipe of the square: the first governed the irrigation runs of the garden and the pipeline was the most important drinking water supply in the centre of the city. The remaining groups, six would be responsible for the high parishes (*San Pedro, Santa María* and *San Juan*) and the two most populous (*San Mateo* and *Santiago*), and the eighth of the neighbourhood of *San Cristobal* on the other side of the river. That same day, it was also agreed that the water should be poured into the mills so that they would be ordinary, that the ovens be repaired, and that bakers and bakers would be looked for to supply the public supply. But in view of the fact that the aftershocks did not end and thinking that the disaster could have been greater, the Lorca councilmen, meeting in the main square, decided on September 1 to vote the city in the following way:

*“La ciudad dijo que por cuanto el día veintiocho de agosto pasado de este año en que sucedió el terremoto que ha destruido la mayor parte de esta ciudad fue día del bienaventurado doctor San Agustín y milagrosamente parece que Dios ntro. Señor por medio e intercesión de dicho santo reservó la vida a los vecinos y que las desgracias que sucedieron en las personas fue nada respecto del gran estruendo y vehemencia con que en un instante se hundió la mayor parte de esta ciudad y lo demás tan destruido como se reconoce y en hacimiento de gracias esta ciudad tiene propósito de votar por fiesta solemne de guardar en ella la fiesta del glorioso santo y doctor de la Iglesia San Agustín y así se dé recado a los señores abad y cabildo para que por lo que les toca le vote y celebre dicha fiesta como de primera clase y en la forma y con la solemnidad que se celebran las demás fiestas de voto de esta ciudad y se escriba a su Ilustrísima el señor*





*obispo de este obispado suplicándole se sirva de dar comisión para que se haga dicho voto solemne en manos del Ilustrísimo señor arzobispo de Durazo...”*

On September 2, the Bishop of Cartagena authorized the particular celebration of that feast and on the 4th, the commitment to make it annually in perpetuity was formalised in the collegiate church. The vow also involved the erection of a small votive temple with the invocation of St. Augustine, which would later be handed over to the Jesuits to raise church and college. The already advanced reforms that they undertook in the place, the order was expelled from Spain and years later would be installed in that enclave, lasting until today, the new parish of *San Mateo*.

On the same day, September 1, the aldermen also agreed to let the Crown know “*del miserable estado en que esta ciudad se halla por causa del terremoto, solicitando su acostumbrada clemencia.*” And, finally, it was commanded that all masonry masters recognise the battered clock tower to see the best way to repair it or to ensure that it did not cause harm. It is to be believed that the most practical solutions in order to normalize citizen life as much as possible, were taken along the lines of events and there is no trace left in the Chapter Acts. The thickness of the agreements of the councillors until the arrival of the royal delegate have to do with general processions in demand of aid to the temples of the most devout Marian images (*vírgenes de los Remedios, del Alcázar y de las Huertas*), having to be suspended that of September 9 for the replicas that were still taking place. Still on October 5, the “*regidores*” having already met in their usual room, it is noted in the minutes that

*“... que atento se continúan los terremotos en esta ciudad acordó se haga procesión de penitencia con Nuestra Señora del Alcázar al convento de Nuestra Señora de las Mercedes redención de cautivos de esta ciudad a Nuestra Señora de los Remedios que es en dicho convento...”*

It was ordered that all the ecclesiastics should be notified to say the usual Masses and prayers.

On November 1 was read in Council the Real Provision of September 15 by which the king appointed commissioned judge for Lorca to Pedro Romualdo de Contreras, Council of His Majesty, mayor of the Royal Chancery of Granada, urging that

*“...viniese a dicha ciudad a reconocer el daño que hizo el terremoto en esta ciudad la noche del día veintiocho de agosto de este presente año y procediese a su reedificación y en el interin tomase la posesión de la jurisdicción ordinaria y lo demás contenido en dicha real provisión...”*,

a full power to act decisively. In the same session, the aforementioned judge took over as extraordinary magistrate and the decisions took another turn. On November 10, the king was asked to pardon the delayed debts of the city to the Royal Treasury, to exempt it from the economic charges derived from the kingdom's taxes and to undertake the repair or reconstruction of public works allow the following excise taxes: half real in each “*fanega*” of wheat from which it is extracted and one quart in each bushel of barley; two “*reales*” of each car and cart that will pass through this term; half of the “*real*” of each major horse and one quart of each minor; and one on the water of the rivers.



The “*regidores*” had already begun to undertake repairs with the funds available to them, but on November 19, faced with the possibility that the beginning could not be concluded, the royal commissioner said

*“... que como a la ciudad consta la obra de la ciudad de ella está muy adelante la cual se ha hecho y reparado con el dinero que cada uno de los vecinos ha mandado voluntariamente por ser el único remedio que tienen para la conservación de esta ciudad y que dicha obra está muy adelante y que con cinco a seis mil reales se podrá acabar de perfeccionar dicha obra y en no hacerse está expuesto a evidente peligro que toda dicha obra se pierda. Y esta ciudad y sus vecinos por falta de medios no ha de poder volver a hacer dicha obra y por esa causa se quedará todo perdido y esta ciudad despoblada y así requiere a esta ciudad vean los medios más suaves de donde se puede sacar la cantidad para acabar dicha obra y habiéndose conferido dijeron que el medio más suave que se puede tomar para ellos es que se hagan fallas de todas las aguas para dicho efecto y habiendo todos concurrido en ello y sido de parecer unánimes y conformes que se hagan dichas fallas acordó que a parecer de los señores comisarios de dicha obra se hagan cuatro fallas y si convinieren más se hagan más. Y el dinero que procediere de ellas entre en poder de Ginés Pinar receptor del dinero de dicha obra para que con él se acabe dicha obra que para ello se les da poder y comisión en forma”.*

This extraordinary means consisted of depriving the owners of the water of the sales that were made in a whole day to irrigate the orchards near the urban centre. The water was auctioned and awarded to the highest bidder and the different portions in which the river flow was divided belonged to the wealthiest families and to ecclesiastical and civil institutions that obtained from them a few annual rents.

On the 26th of January, the real answer finally came to Lorca's requests for help, which said:

*“... que con el conocimiento cierto referido y vista del informe del dicho Don Pedro Romualdo De Contreras, mandásemos al nuestro Consejo de Hacienda que por doce años se eximiese a esa dicha ciudad y sus vecinos de todas las contribuciones reales, aduanas, almojarifazgo y del repartimiento de milicia y donativos y otros cualesquier en adelante hasta cumplirse dicho tiempo como se había hecho en la villa de la Zarza en Extremadura remitiéndole también los débitos atrasados hasta dicho día veintiocho de agosto de dicho año de setenta y cuatro y asimismo para la reedificación de las obras públicas que como casa de ayuntamiento, carnicerías, pósito, cárcel, fuentes y canales de las aguas, conceder arbitrios para ello como medio real en cada fanega de trigo y un cuartillo en cada una de cebada que saliese de esa dicha ciudad y medio real en cada arroba de aceite que pasase por ella y otro medio real encada arroba de atún salado o fresco que saliese de esa dicha ciudad por mar o tierra de lo que se pescara en las almadrabas de Cope y Calabardina, término de ella, pues de otra suerte no sería posible el conseguirse la reedificación de esa dicha ciudad como tan necesaria o como la nuestra merced fuese...”.*





But the truth is that some of the economic measures granted were turned against the city itself, hardening the economic conditions of its neighbours. This was made known to the Crown on February 11, 1675 to modify the measures of grace:

*“Se han reparado hasta ahora la fuente, el reloj y su torre, la puerta de Nogalte tomando el dinero prestado a daño por falta de propios sin haber alcanzado a poder reparar la cárcel, salas de ayuntamiento y las canales, edificios por donde de necesidad ha de pasar el agua para los riegos de parte de la huerta. Y los demás edificios públicos se están sin reparar. Y los pobres vecinos han hecho algunos reparos que han podido de sus casas. Y los que no, aún se están en barracas en el campo, con grandes incomodidades y menoscabo de las labores del campo en que los más se ocupan y es la única conveniencia y trato de esta ciudad y que han menester mucha ayuda para reparar sus casas para poder morar con seguridad en ellas. Lo que esta ciudad paga de servicios en cada un año ajustado por un quinquenio se verá por los testimonios que acompañan esta relación y los débitos atrasados por la certificación de la contaduría de Murcia que va con ellos. Los arbitrios que por esta ciudad se propusieron mirado más despacio reconocer que recargan sobre los vecinos y pueden embarazar en parte el comercio y venta de frutos con que deseando su alivio y reconocimiento el glorioso celo con que Vuestra Alteza los desea ayudar, le parece que los medios más proporcionados serían si Vuestra Alteza fuese servido conceder a esta ciudad por tanteo el arrendamiento de las alcabalas y rentas y unos por ciento en la cantidad que hoy está y conceder a esta ciudad el arrendamiento de los servicios de millones por lo que le corresponde prorratio al precio en que los tenía el arrendador que ahora se han puesto en quiebra, porque se excusa a los vecinos la molestia que trae consigo la administración, y hacer remisión a esta ciudad de los dichos débitos atrasados, y de las contribuciones del servicio de milicias y ordinario y extraordinario por ser éstos los que recargan sobre la gente más miserable por haber tantos privilegiados de ellos, y que asimismo sean libres por el tiempo que a Vuestra Alteza fuere servido de los almojarifazgos y los demás derechos agregados. Esto suplica esta ciudad a Vuestra Alteza...”*

## ***Tectonic frame***

The earthquake of Lorca is located in the Internal Zones of the “*Cordillera Bética*”, commonly known as the “*Dominio de Alborán*”. This domain is structured by a series of tectono-sedimentary complexes, composed of Paleozoic, Mesozoic and Tertiary rocks arranged in a stack of shifting mantles generated during the formation of the Alpine Orogen. The neotectonic period in the eastern sector of the “*Cordillera Bética*” would begin after this extensional stage about 9 Ma, dominated by a compressive regime with a maximum shortening NO-SE controlled by the convergence between the European and African tectonic plates. The data of GPS speeds calculated in recent years through regional models in the western Mediterranean suggest a regional shortening in the east of the “*Cordillera Bética*” between 4 and 5 mm per year according to the almost orthogonal direction of the FAM. GPS speeds of a more local character obtained by the Cuateneo network [7], however, indicate somewhat more northward directions and more coherent with the sinistral tearing component presented by the FAM.

The geodetic velocities, in any case, indicate that the speeds of movement that can be expected in the active faults of the “*Béticas Orientales*” must be less than 1 mm / year for each of the individual faults. In the case of the FAM, this is consistent with geological observations for neotectonic time periods and paleoseismic studies on quaternary materials that indicate speeds ranging between 0.08 and 0.5 mm / year [8].

In relation to the tectonic regime of seismicity, the focal mechanisms of earthquakes of magnitude greater than 3.5 in the east of the “*Béticas*” indicate the existence of different stress and deformation regimes at different scales, with normal and normal-directional earthquakes component associated mainly with failures of orientations ranging from NE-SE to NS, while mechanisms of a more compressive nature, inverses or inverses-directional, are mostly associated with faults with an orientation closer to the perpendicularity to shortening regional (NE-SO to EO). In this sense, most of the focal mechanisms throughout the FAM present this compressive character with kinematics that go from sinistral-inverse to inverse [9].



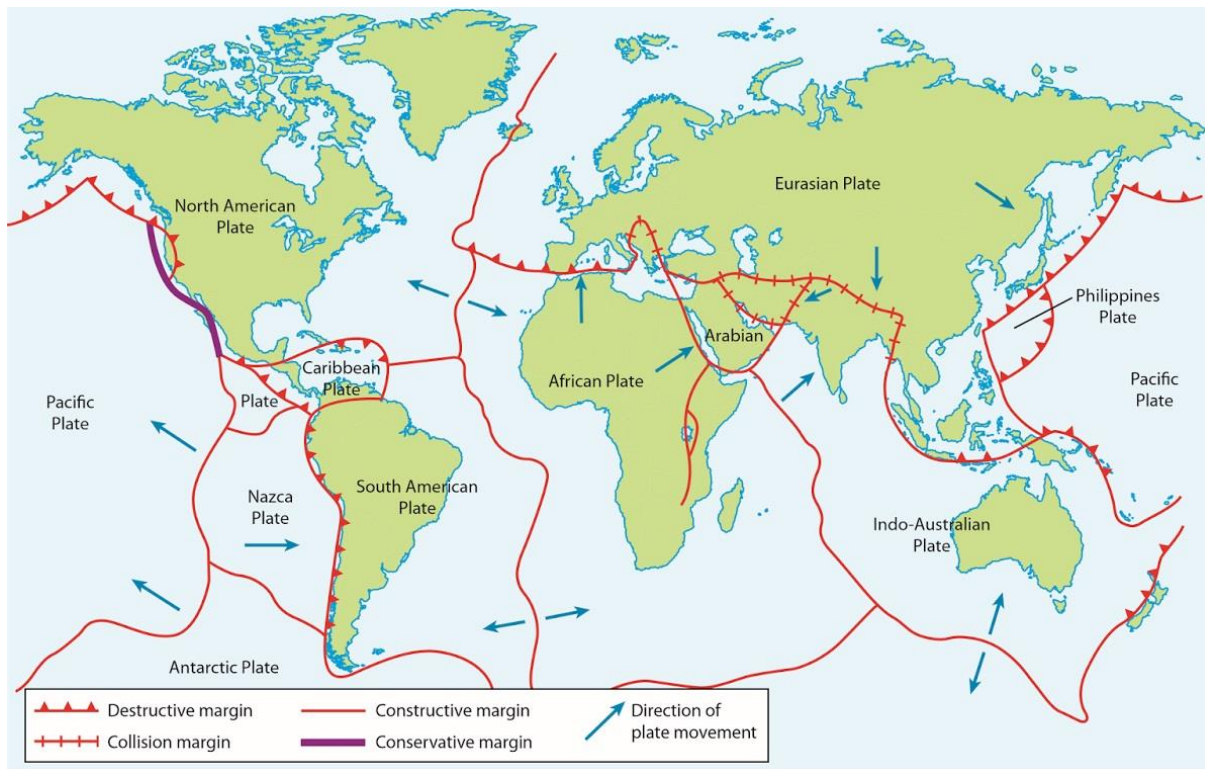

Figure 2: Tectonic plates distribution.

A conservative plate boundary, also known as a slip or transform plate margin, happens where plates slide past each other in opposite directions, or in the same direction but at different speeds.

Friction is eventually overcome and the plates slip past in a sudden movements causing an earthquake releasing seismic waves from the focus across the epicentre and thus shaking the earth's crust.

In the context of Spain, the Murcia region has moderate to high seismicity. In Table 1.1 is presented the recurrence rate of events by ranges of Magnitude. In 1977, 1999, 2002 and 2005 have occurred events, producing considerable economic losses. In Table 1.2 are presented the magnitude, the maximum macroseismic intensity observed, the Peak Ground Acceleration (PGA) recorded for the events and a brief description of the damages.

Magnitude	Recurrence rate (events per year)
>7	0,006
6,1 - 7	0,033
5,1 - 6	1,2
4,1 - 5	16,6
3,1 - 4	219,0
2,1 - 3	584,0

Table 1.1. Earthquake recurrence rate (events per year) by ranges of magnitude.

Recently, in May 11 of 2011, an earthquake of Mb 5.1 stroke Lorca. The PGA recorded was about 0.38 g. This acceleration is higher than the PGA estimated for Lorca in the Spanish building code for a return period of 500 years (0.12g) [22]. At April 19 of 2012, the damage of buildings is described as follows: from a sample of 6419 buildings (35% of the buildings of the city), 63% were classified as habitable, 21% of the buildings had light or insignificant structural damages and 11% of the buildings suffered structural damages and its occupancy was prohibited. The remaining 5% were heavily damaged and have been demolished (Ayuntamiento Lorca, 2012 report). In terms of economic damages, at December 29th of 2011, the estimated losses, only in insured buildings, were around 332.5 million of euros. From this amount, 256.9 million corresponds to damages in households; 36.8 millions of damages in commerce and stores, 4.9 million in damages in industries; 2.9 millions of damages in vehicles.

Date	Location	Magnitude	Macroseismic intensity	PGA	Observations
February of 1999	Mula	4,7	VI	0,012	Near of 5000 residential buildings were affected. 18.5 % suffered significant structural damages. The damages on insured buildings were around 15.6 million of euros.
August of 2002	Bullas	5	VI	0,02	Old buildings suffered light damages on architectural elements. The damages on insured buildings were around 1.6 million of euros.
January of 2005	La Paca	4,8	VII	0,032	More than 900 residential buildings were affected. The Government of Spain and Murcia delivered 4.8 million for the reconstruction. 0.3 million were used for the management of the emergency. The damage on insured facilities was around 8.1 million.

Table 1.2. Most relevant Earthquakes occurred in the Region of Murcia. Sources: ABC.es (2012), Ayuntamiento Lorca (2012), Consorcio de seguros (2011), Ministerio de Fomento (2002), Rinamed (2011).



Given the seismicity of the region, seismic risk should be a matter of planning based on the analysis of the expected losses. In this regard, a probabilistic seismic hazard assessment, as well as the evaluation of seismic scenarios for return periods of 475 years have been developed in the project RISMUR.

Due to the uncertainty in the estimation of the seismic hazard and the buildings vulnerability, questions arise about the recurrence rate of the events and its consequences, as well as the reliability of risk management programs based on the damage assessment of specific scenarios. Then, in order to support risk based decisions, this work presents the application of a methodology for the estimation of the expected losses in the Province of Murcia, taking into account all possible seismic events. This analysis allows estimating the probability of exceedance of the loss associated to the recent events, the probability of exceedance of a given loss in a given time frame, as well as the probability of exceedance of a given loss in the following  $t$  years. Those metrics are useful in order to highlight the relevance of the problem, influencing upon risk perception and avoidance.

### ***Seismic risk assessment in the region of Murcia.***

The total value of the buildings of the Region of Murcia was obtained from the data available in cadastral statistics. The exposed value is around 54000 million of Euros. The exposed value was regionally distributed according to the population of each entity. Also, buildings have been classified into structural typologies, based on the classification by vulnerability classes (A, B, C, D) developed in the project RISMUR.

The typologies considered were simple stone masonry bearing walls (M12L, Low rise), unreinforced masonry walls with composite steel and masonry slabs (M33L, Low rise), unreinforced masonry walls with Reinforced Concrete - RC- slabs (M34M, mid-rise), irregular RC structures with infilled masonry walls (RC32L, Low Rise), regular RC structures with infilled masonry walls (RC31M, mid-rise) and steel moment frames with infill masonry walls (S3M, mid-rise). This classification was developed taking into account the construction period of buildings and the classification of the population entities in urban or rural. The height of the buildings has been considered according to the statistics of number of floors (INE 2012). In Fig 2.1 (a) is presented the percentage of buildings by number of floors. In Fig 2.1 (b) is shown the percentage of the exposed value by structural typologies. Also, in Fig 2.2 (a) is presented the location of the Region of Murcia and (b), the exposed values on each population entity.

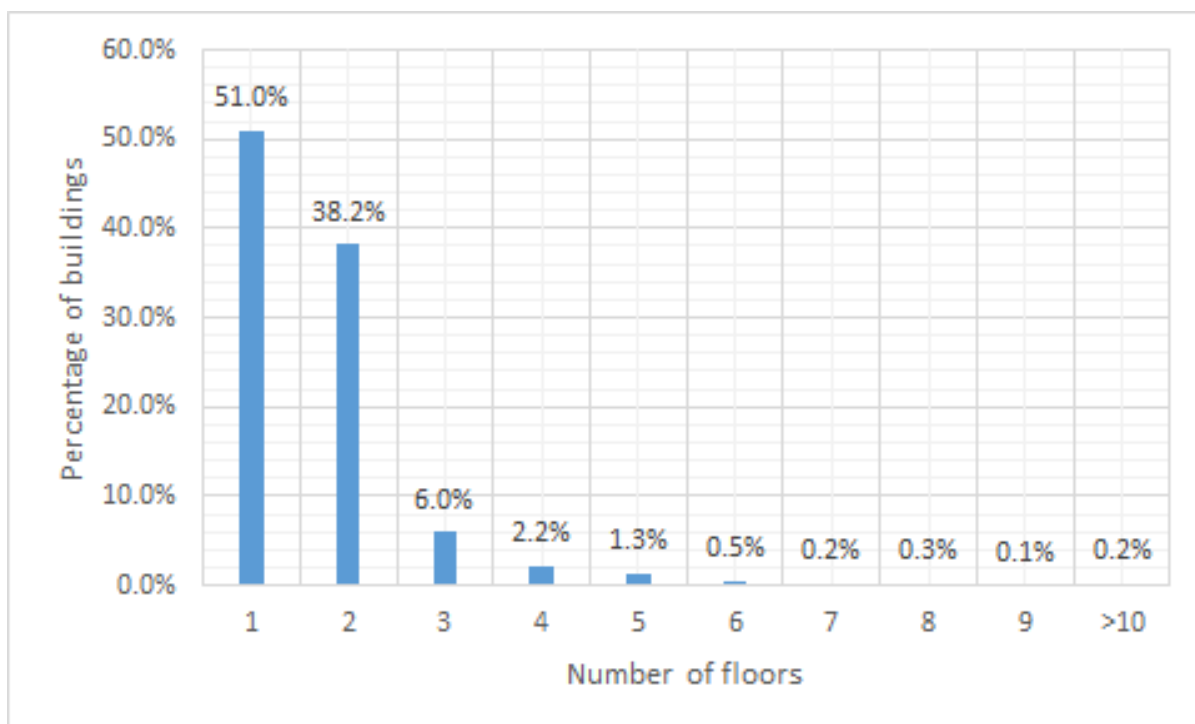

Fig 2.1 (a): percentage of buildings by number of floors.

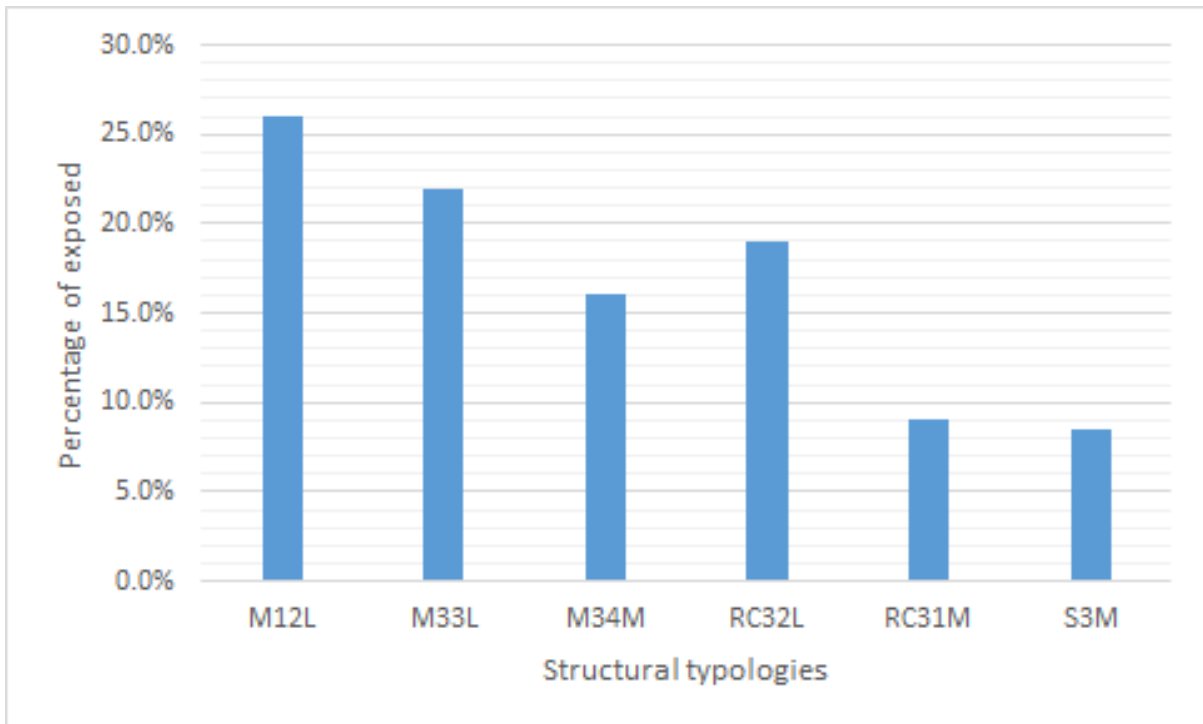

Fig 2.1 (b): percentage of the exposed value by structural typologies.

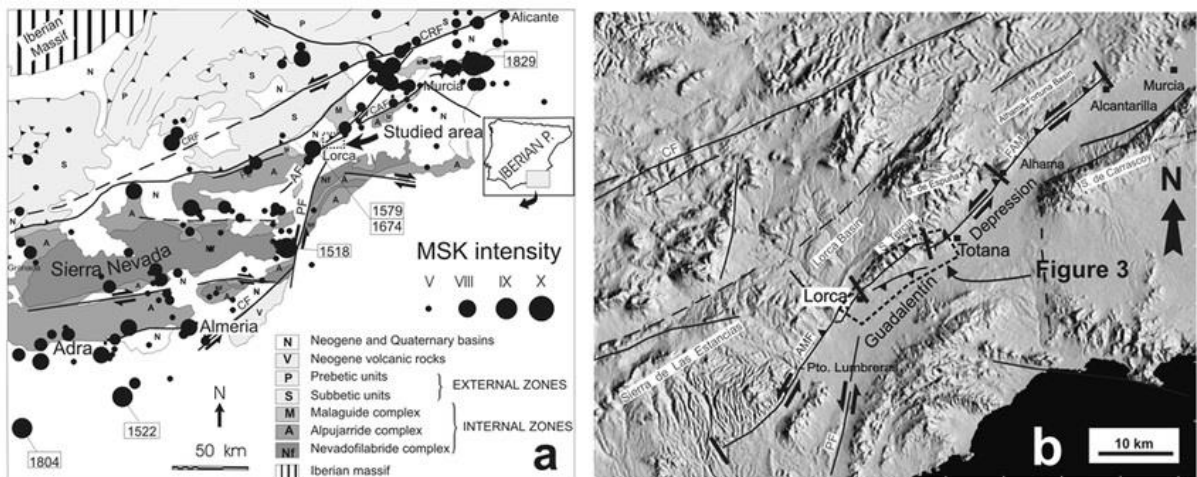

Figure 3. (a) Macroseismicity map of eastern Betics with the main Neogene faults. Indicated fault movements correspond to late Neogene. CRF, Crevillente fault; AF, Alhama de Murcia fault; CF, Carrascosy fault; PF, Palomares fault; CF, Carboneras fault. (b) Topographical model of the surroundings of the Alhama de Murcia fault, next to the Neogene Guadalentín depression. The segment boundaries along the Alhama de Murcia fault are indicated by black bars.



It is presented an initial characterisation of the seismic series began on May 11, 2011 to the May 17, 2015; with the seismic data of the National Geographical Institute.

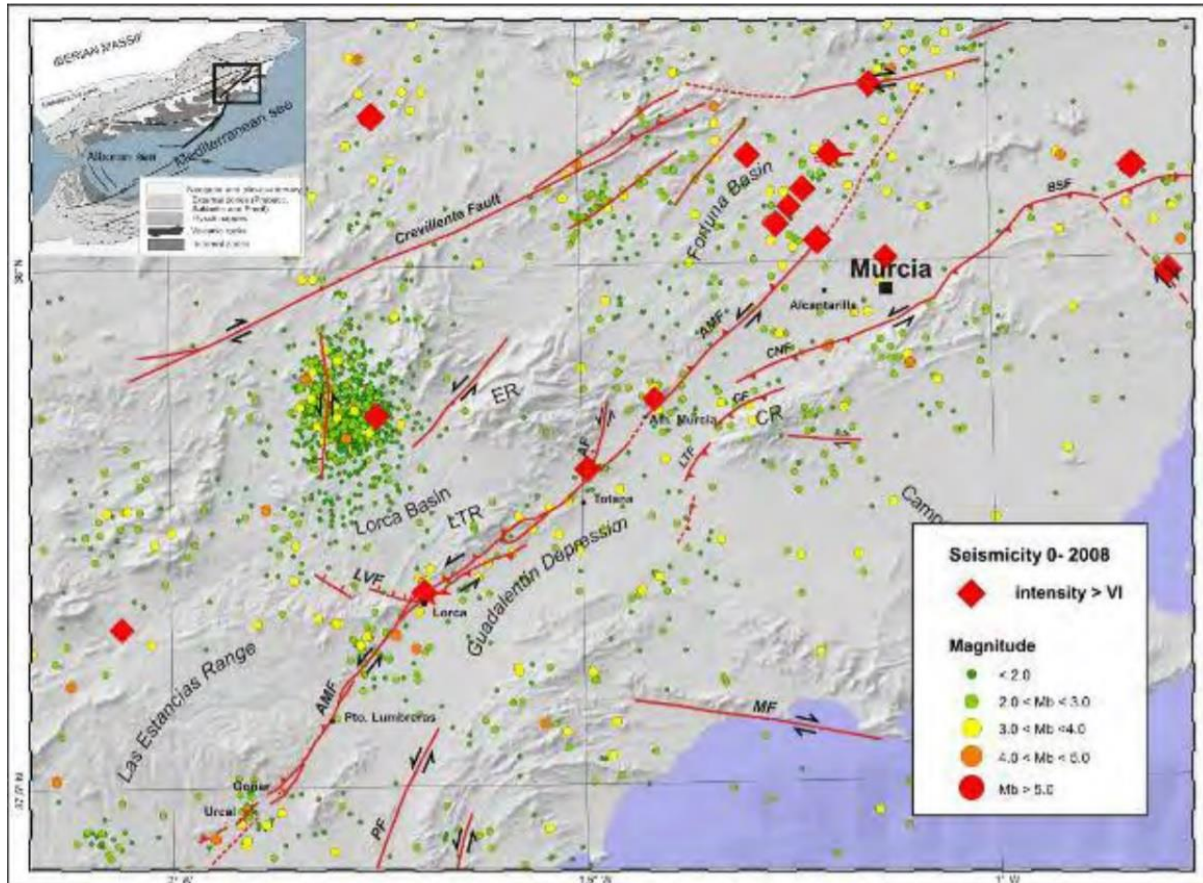

Figure 4: Map of seismicity in the area until the year 2015. The red diamonds indicate the position of destructive historical earthquakes. The circles show the epicentres of earthquakes with the colour depending on the magnitude of the event. The red lines show the traces of major active faults.

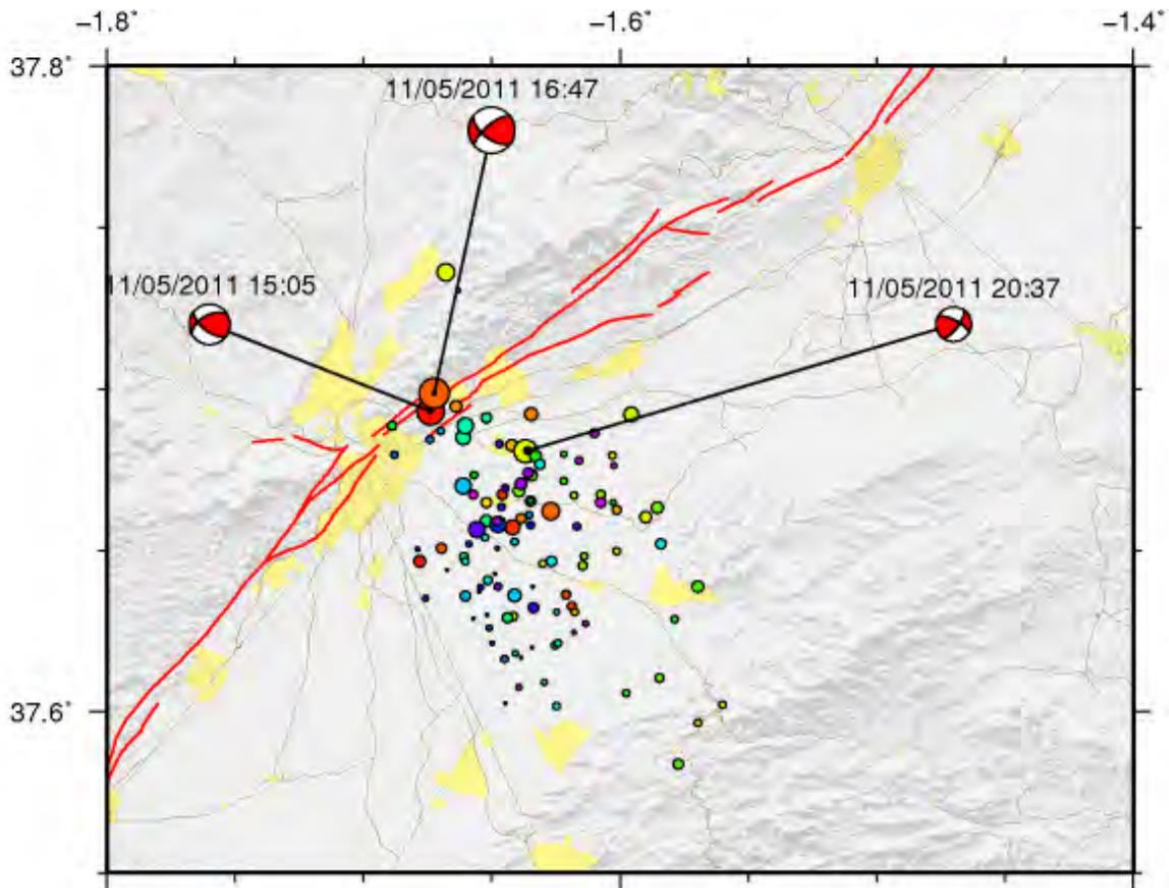

Figure 5: Map showing the seismic series. The size of the circles is proportional to the magnitude of the event. The colour is a function of its position in the series as shown in the bottom graph of temporal evolution. Focal mechanisms of major events show the characteristics of movement of the rupture, in this case are left-lateral strike-slip faults with reverse component. In red line the traces of the main active structures are shown. The chart below shows the time evolution of the series. Circles represent each event with size proportional to the magnitude (left Y axis), its colour is a function of position in the series. The grey bars show the number of events in intervals of 3 hours. Notably the peak of activity on the night of 14 to 15 May. The dashed line shows the threshold at which the magnitudes are expressed as MW instead of as mbLg.

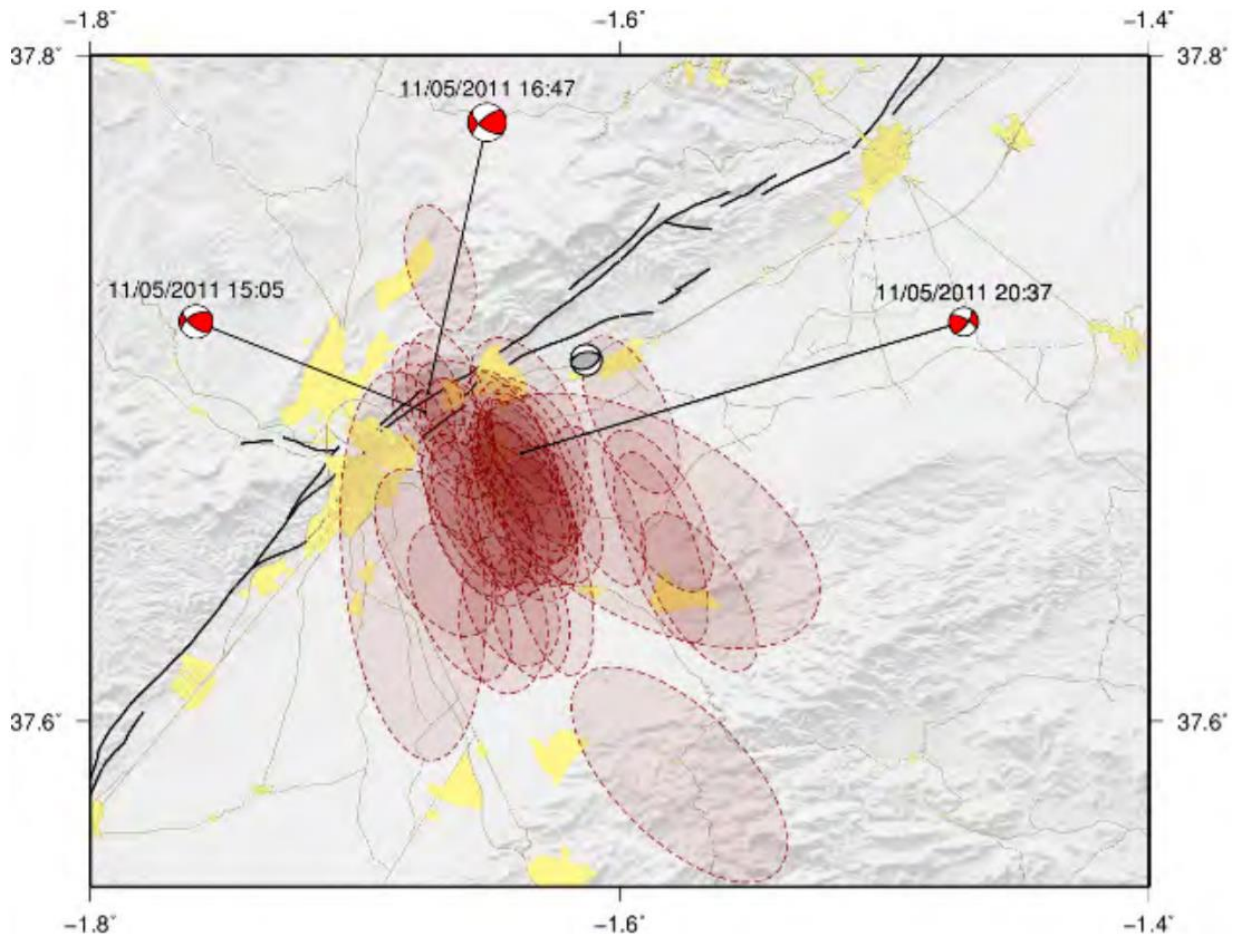

Figure 6: Map of error ellipses on the location of seismic events in the series with mbLg magnitude higher than 1.5. Focal mechanisms shaded in red correspond to the three main events of the series occurred on 11/05/2011, grey focal mechanism corresponds to an event occurred on 08/03/2006.

It has also been conducted a preliminary analysis of Coulomb stress transfer. This methodology looks at the degree of influence of an earthquake rupture on the surrounding faults. Depending on the direction of the fault and its position with respect to the earthquake generating fault, these surrounding faults can be increased in their likelihood of rupture (of generating an earthquake) or decreased. Figures 7.1 and 7.2 show these tests. The red colours imply a positive change in Coulomb stress, and it could be interpreted as an increasing of the probability of occurrence of another event in these areas. Blue colours in contrast show areas where the stress has fallen so that lowers the probability of occurrence of earthquakes. However, it must bear in mind that these calculations are done on determined fault planes and that increased stress in one fault plane, for example, N-S, does not preclude that other fault planes, e.g. E-W, may show a decrease of stress.

In Figure 7.1 it is shown the calculated stress changes produced by the main earthquake of magnitude 5.1 MW assuming a rupture with NE-SW direction, calculated on fault planes with the same strike and dip, i.e. the type of FAM plane. In Figure 7.2 it is shown the same calculation but assuming the plane NW-SE as the responsible of the earthquake. Regardless of which of the two planes has caused the event, the Coulomb stress change on the fault plane of the FAM is practically the same. There are two lobes of increased stress on the ends of the segments Puerto Lumbreras - Lorca (south) and Lorca - Totana (north) and two orthogonal lobes. On the southern lobe of the latter is being developed the series of aftershocks. The two lobes of increased stress on the two segments of the FAM implies that the probability of generating a new event in this fault has increased. These results should be refined once the rupture is better defined.

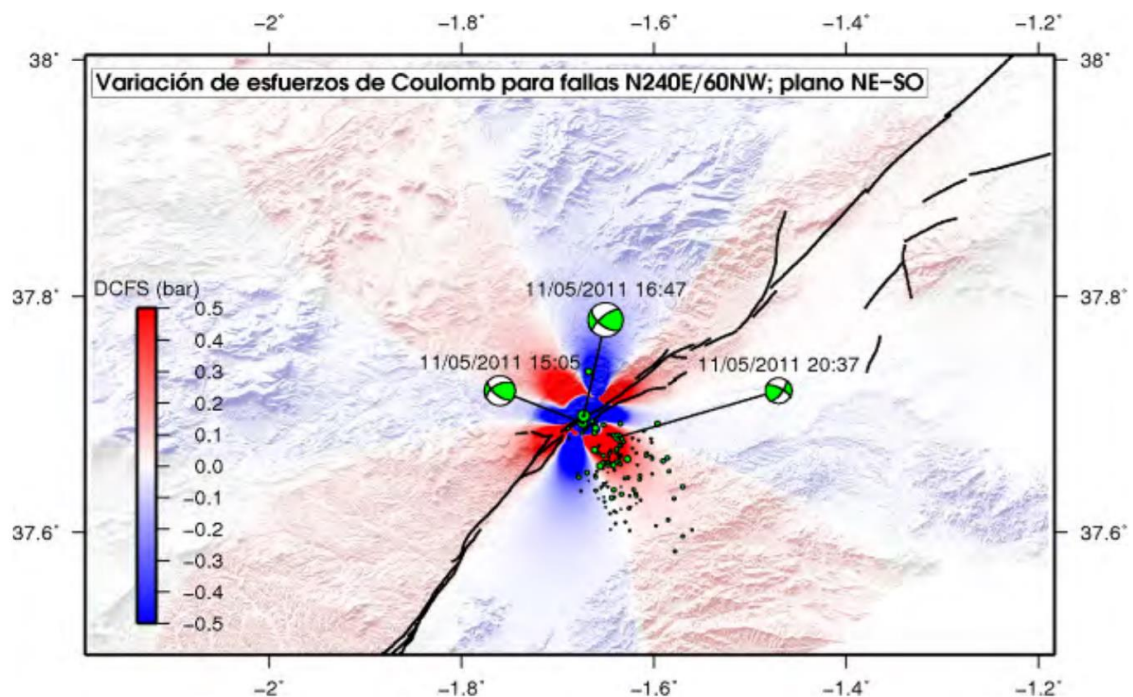

Figure 7.1: Map of Coulomb stress variation on NE-SW fault planes (type FAM) generated by the NE-SW plane of the focal mechanism of the main event of the series. The colours indicate the variation of stress (shown in colour scale). The red colours indicate an increased likelihood of generating new events.

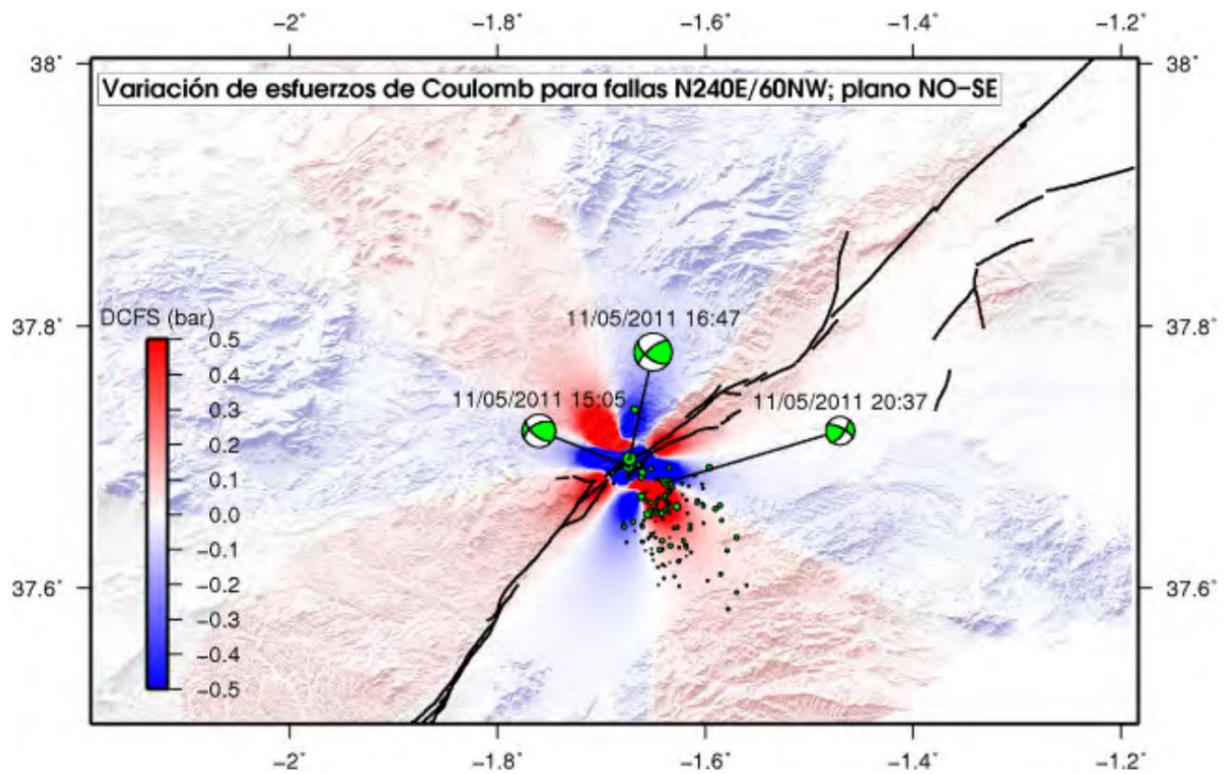

Figure 7.2: Map of Coulomb stress variation on NE-SW fault planes (type FAM) generated by the NW-SE plane of the focal mechanism of the main event of the series. The colours indicate the variation of stress (shown in colour scale). The red colours indicate an increased likelihood of generating new events.



### ***Geology of the epicentral zone: geological source of the earthquake***

The epicentre of the Lorca earthquake was located about 3 km NW of the FAM trace. During a geological reconnaissance on the ground conducted two days after the earthquake, no evidence of surface rupture was found, so that most of the surface effects consisted in years of building and rock falls described and evaluated in preliminary reports after the earthquake (IGME 2011) and recent studies [10]. The focal mechanisms calculated by the different agencies are quite homogeneous and all have a focal plane subparallel to the FAM plane already described from previous studies in the field. The local structure of the FAM has been mapped in detail from field data, previous cartographies and a digital terrain model derived from LIDAR data from the Community of Murcia, “*Cartomur*”. In this zone the FAM undergoes a change of direction from N55 ° to N35 °. The structure of the fault is complex, composed of several branches due to the existence of a compressive tear duplex called “*Matalauva*” duplex [9] and the interaction with a secondary ONO-ESE fault that limits the “*Sierra de Las Estancias*” by the N (*Las Viñas* fault) and that together generate an elongated block along the fault subjected to contraction that causes the differential lift of the corner NE of the aforementioned mountain range as well as the outcrop of Palaeozoic rocks inside the duplex.

To the north of the duplex structure there is a complex interaction between reverse faults, normal and tear faults that disrupt the NE-SO folding parallel to the FAM responsible for lifting the “*Sierra de La Tercia*”. The complex cutting relationships between these structures affecting upper Miocene materials support the existence of local variable shortening directions probably associated with processes of blocking the movement of the FAM in the duplex structure that would act as an area that hinders the slippage of the fault and that it could have acted as a roughness during the earthquake [9].

### ***Implications of the earthquake of Lorca in the seismic danger.***

The Lorca earthquake occurred, according to the models, by the movement of an area of the fault of about 4 x 3 km. This rupture has induced a change in static forces that may condition the stability of other segments of the FAM. The surface accumulation of replicas would be off fault replicas and seem to be associated with the reactivation of secondary faults of kinematics other than FAM within the raised block similar to those described in the previous section. Nevertheless, the most important aspect in relation to the influence of the Lorca earthquake on the seismic danger of the area is the change of CFS caused by it in the adjacent segments of the FAM.

It has been recognised in previous paleoseismic studies that these segments have generated earthquakes with surface rupture and magnitudes  $M_w > 6.5$  [8] and, therefore, their reactivation would involve much greater surface effects in Lorca than those generated in the earthquake. The largest increase in CFS over the FAM induced by this earthquake is located in the two surface sections of the FAM adjacent to the 2011 rupture and in the deepest zone of the fault under the 2011 rupture, below 5 km. Of the two charged surface areas, the southernmost coincides with the position of another FAM complexity, defined as a tear duplex in previous works with dimensions similar to the area that is interpreted as generated by the 2011 earthquake. The change of forces in this structure exceeds 1 bar, a value that has been shown to be sufficient for the generation of triggering processes [13]. The most eastern sector is located in the area of the “*Carraclada baños*”, where the FAM is also structured in a duplex, although of smaller dimensions.

The recurrence interval of an earthquake in a fault segment subjected to load stress is controlled by the frictional properties of the fault and the static and dynamic changes induced by it by nearby earthquakes [13]. In a fault subjected to a stress load with a constant bottom rate, a positive CFS change produces an advance in the seismic cycle equivalent to:

$$\Delta T = \Delta CFS / \tau_1$$

where  $\Delta T$  is the lead time,  $\Delta CFS$  is the Coulomb effort change suffered and  $\tau$  is the stress load rate on the fault. Considering a constant displacement in the deep and ductile part of the fault, rates of change of effort on the fault between 0.001 and 0.005 bar / year are obtained, considering a speed of movement for the fault oscillating between 0.1 and 0.6 mm / year. Under these conditions, a change of 1 bar over the fault would imply an advance in the seismic cycle of 200 to 1000 years.

The ignorance of the current state of efforts on the failure makes that this data cannot be used to quantify changes in the seismic danger of it. However, if compared with the recurrence intervals calculated by paleoseismic and geological data for the segments adjacent to Lorca, this advance can constitute between 5 and 28% of the recurrence interval.



### ***Analysis of the geological source of the earthquake: “The Alhama de Murcia Fault”.***

The position of the epicentres of the Mw 5.1 main shock and the Mw 4.5 foreshock is spatially consistent with the location of the “*Alhama de Murcia*” fault trace 2 km northeast the city of Lorca (Figure 8.1). The FAM was first described by Bousquet et al. (1979) and it was the subject of a number of structural, seismotectonic and paleoseismic analysis and works showing its quaternary activity and high seismogenic potential. The FAM is oblique-slip sinistral strike slip fault with a reverse component. It extends along the north-western flank of the “*Guadalentín*” depression, from *Alcantarilla* to *Goñar*, reaching a total length of at least 85 km. The fault is structured in several segments with variations in strike and degree of complexity along the fault (Figure 8.2).

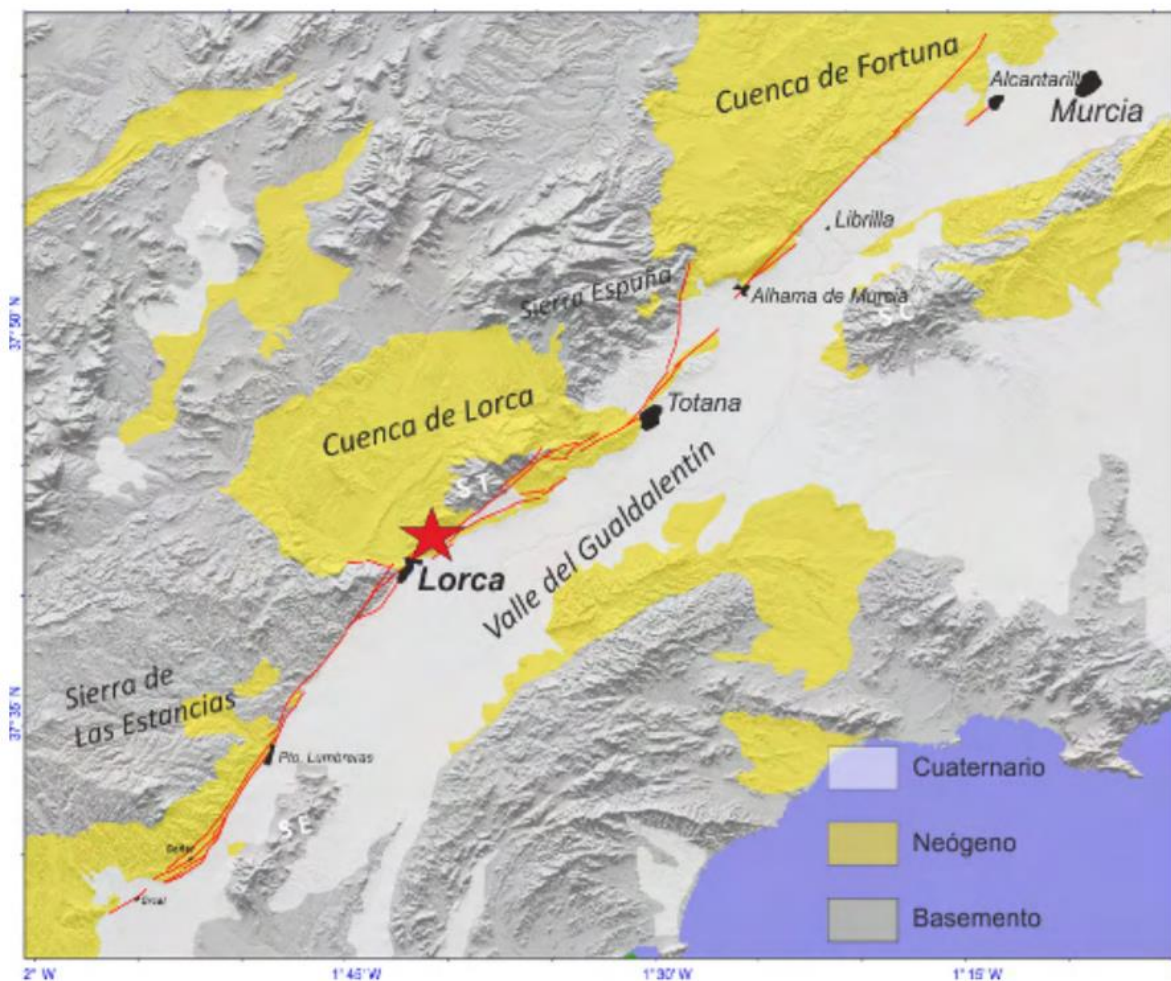

Figure 8.1: Map of the fault trace of the Alhama de Murcia Fault. The star indicates the position of the epicentre of the Mw 5.1 mainshock.



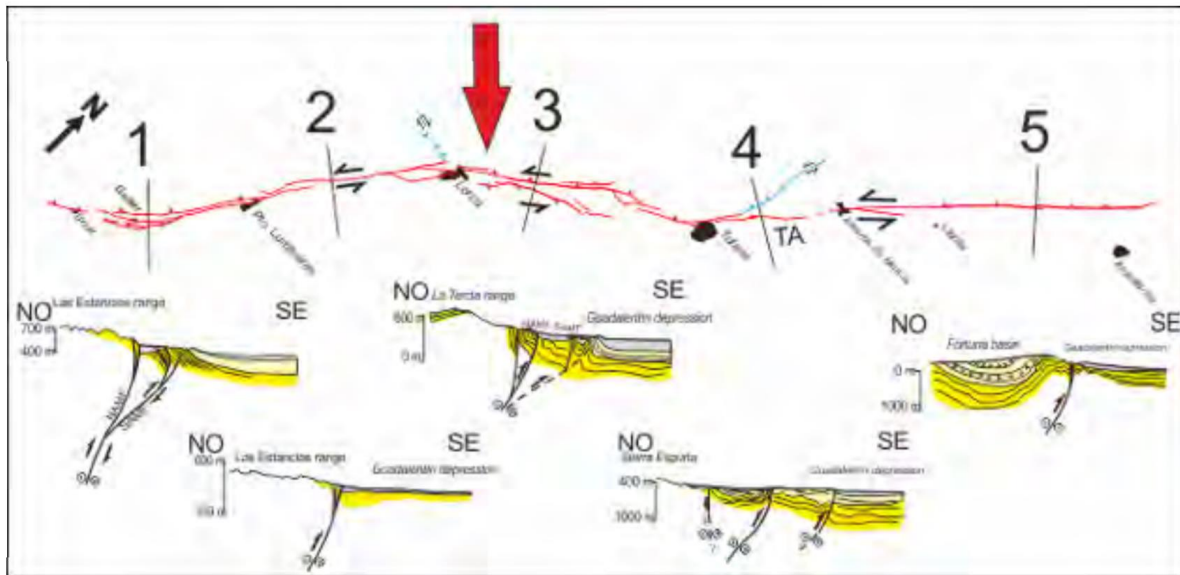

Figure 8.2: Structure of the Alhama de Murcia fault taken from Martínez-Díaz et al. (2010). The red arrow marks the position of the epicentre of the Lorca Mw 5.1 earthquake that is located at the western tip of the Lorca-Totana segment. In the lower part we show the cross section structure of the fault interpreted from surface geological data.

Focusing on the epicentral area the position of the larger events seem to be related to an area where the FAM has a rather complex structure (Figure 8.3), with two main branches with opposite dip: The Northern Lorca Corridor dipping to the NW and the South Lorca Corridor dipping to the SE. The uncertainty ellipse of the epicentre location calculated by the National Geographic Institute indicate that they could be related to either of the two branches, although it seems more likely the location associated with the Northern Corridor. This corridor consists of a compressional strike-slip duplex structure formed with two parallel branches one of which run to the SW below the town of Lorca and the other pass along the NW flank of the Castle of Lorca hill (Figure 8.4). In any case the structure of the fault as it passes through Lorca is quite complex. It undergoes a slight change of direction and could have several active branches in the underground of the town. The geometry and kinematics of one of the two planes of the two focal mechanisms (plane NE-SW high dipping to the NW) is coherent with the two faults that form the duplex, since they present a sinistral strike-slip movement with reverse component during the Quaternary, also consistent with the plane solutions.

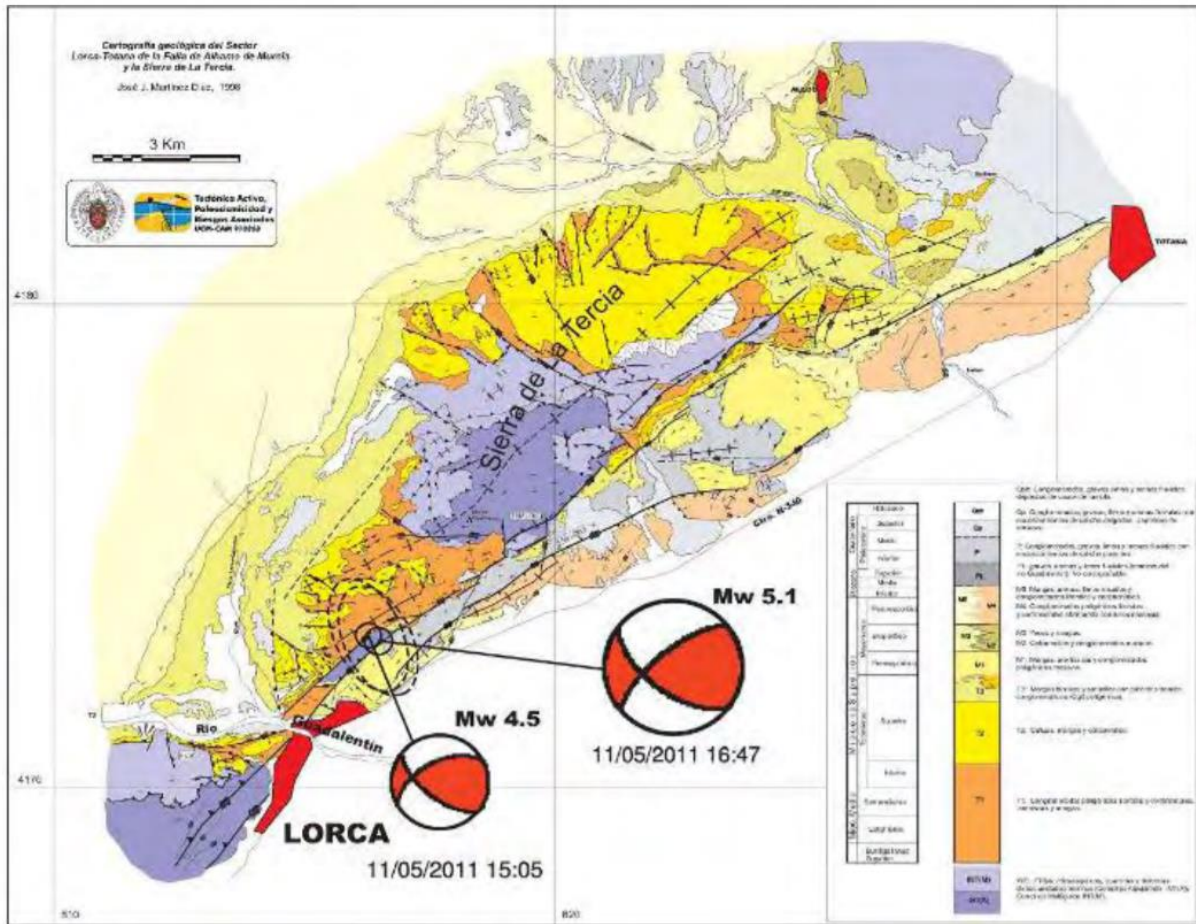

Figure 8.3: Geological map of the Lorca-Totana sector of the Alhama de Murcia fault with the epicentres of the two major earthquakes and the focal mechanisms calculated by the Instituto Geografico Nacional. Geological mapping is taken from Martínez-Díaz (1998).



Figure 8.4: Panoramic view of Lorca taken from the epicentral area. The red traces show the position of the main branches of the FAM. The two faults that go towards the city bound the duplex structure formed by a block of basement rocks uplifted under a transgressional regime and flanked by Miocene sedimentary rocks.

While the analysis of the surface geology and the position of the epicentres clearly point to the FAM as responsible for destructive earthquake, the position of most of the aftershocks located to the SE of the mainshock, into the “*Guadalentín*” valley, would not fit with this interpretation. One possible explanation is that the aftershocks respond to the reactivation of minor faults located within the valley away from the FAM and triggered by the mainshock. In this case no aftershocks are being producing around the rupture zone in the FAM. Another possibility is the existence of a localization misfit due to the high uncertainty of the location of low magnitude aftershocks using the regional seismic network. A third possibility is that the fault responsible is not the FAM but an unknown NW-SE, crossing from the epicentre to the valley. The higher number of seismic observations of the mainshock, coherent with the smaller size of error ellipses, makes less probable this third possibility. In any case it is necessary to carry out a relocation of the aftershocks and mainshocks hypocentres in order to make a definitive interpretation.



## 1.4. Building damages and affected areas

The main earthquake of magnitude 5.1 Mw occurred approximately 2 kilometres northeast of the city of Lorca. By making a simple spatial analysis of the damage, two conclusions can be defined:

- Heterogeneity: the material damage and the victims are mostly concentrated in some 7 or 8 specific geographic points scattered around the city; and
- Independence of the epicentres: paradoxically, the areas near the epicentres (neither the structures nor the houses a few meters from the epicentre suffered great damage) in fact, the neighbourhood “*La Viña*” (ground zero) is one of the most distant points of the epicentre.

From the moment that the earthquake took place, the emergency assessment was carried out, in which a large and heterogeneous group of volunteers, made up of engineers and architects, have been participating. According to the IGN, the end of this evaluation corresponds to an initial evaluation of reference in the safety and habitability of the buildings.

This evaluation consists in labelling the buildings with a colour code (green, red, yellow). The green colour means that the building is safe and habitable, it can present small breaks, cracks or landslides. The yellow colour indicates damaged building with possibility of access in case of eliminating the risk (demolition of parapets, roofs, etc.). The use of these buildings can be granted with caution, guaranteed that there are no structural damages that compromise their overall stability. The red colour indicates structurally damaged building with prohibited access.

A total of 7839 buildings were analysed at the end of the first week of the earthquake. These data have been incorporated into the municipal planimetry in order to provide georeferenced damage data for a territorial perspective.

The result was that 5,155 of them had a traditional structure and the 1,607 technological structure. Of the 889 affected buildings (13.1% of the total buildings), 550 had moderate structural damage (yellow label) and 326 serious structural damage (red label), in addition to the 13 demolished buildings.

Noteworthy is the incidence of damages in some census districts of the neighbourhood of “*La Viña*”, such as numbers 1013 and 1024 with percentages of damaged buildings of 41% and 40% of the total of the buildings in the district. The census district 1004, representative of the historic centre, suffers yellow or red damage in 16% of the total buildings in the district. The district of the Avenue of the Armed Forces (*El Barrio de la Avenida de las Fuerzas Armadas*), represented by the 1027 district, has damage to 40% of the total of buildings.

The earthquake of Lorca was responsible for a large amount of damage and seismic intensity on a wide range of buildings in the city of Lorca, including the historical buildings. The historical damaged buildings is observed not only in older buildings such

as the portico of “*San Antonio*”, (whose origin is an ancient defensive wall of the XIII century), but in churches and monasteries around the cultural centre Lorca. Aerial view shows a concentration of damage in the highest towers, mainly affecting the arches, buttresses canopies, bollards etc. Rotations also appear in decorative elements such as bollards and obelisks, like the obelisk in the *San Francisco* church.

According to the experience of ancient earthquakes happened worldwide, an earthquake of 5.1 magnitude should not have generated such a seismic intensity (VII EMS; [www.ign.es](http://www.ign.es)). However, being shallow and the rupture spreads from the epicentral area to the southwest, we can assume that much of the rupture of the fault responsible of the earthquake was just below the village (assuming the FAM as the structure responsible). Moreover, alluvial continental deposits generated in the glacia of the *Sierra de la Tercia* and deposits of *Guadalentín* River have amplifying properties to for the seismic waves.

Lorca's earthquake has not produced widespread buildings collapses (only two buildings collapsed), during the inspection we have recognised, classified and described more than one hundred effects of the earthquake on buildings and structures. These authors defined them as Archaeological Earthquake Effects, (commonly known as EAE). The analysis of these deformation structures in historic buildings is very important to identify and quantify historical earthquake damage in archaeological sites.

The EAE describe and quantify coseismic deformation in archaeological sites and historic buildings. It was classified according to EAE:

1. Permanent deformation of the surface; and
2. Temporary deformation by the seismic ray during the earthquake.

It is important to correlate the different earthquakes damages in the historic town of Lorca described by EAEs type structures with the physical parameters of the earthquake and the geology and the seismotectonic models. Thus, it is possible to determine the orientation of maximum horizontal compression ( $\sigma_1$ ) that the city suffered during the main shock, which lasted about 5 seconds (Mw 5.1).

Figure 9.2 shows the table of classification of EAE with the keys used in the location map.

The most relevant key of this archaeoseismic study is applied instrumental information of this earthquake to correlate the EAEs defined in historical earthquakes affecting archaeological sites with historical buildings and modern buildings. This information also can be correlated with seismic and geological parameters, such as the magnitude and focal mechanism of earthquakes, the seismogenic fault and site effects due to the geology of Lorca.

The earthquake of Lorca is an ideal example to study deformation associated during an earthquake and to correlate the damages with the seismic intensity and parameters of the earthquake, such as magnitude, depth and geometry of the seismogenic fault. Hence, we can extrapolate these results of the Lorca earthquake (May 11th) to other studies of archaeological sites with near field effects.



EARTHQUAKE ARCHAEOLOGICAL EFFECTS (EAE)	
<b>I. PRIMARY EFFECTS (DIRECT EFFECTS)</b>	<p style="text-align: center;"><b>GEOLOGICAL EFFECTS</b></p> <p><i>On-fault geological effects</i></p> <ul style="list-style-type: none"> <li>- Fault scarps</li> <li>- Seismic Uplift / subsidence</li> </ul> <p><i>Off-fault geological effects</i></p> <ul style="list-style-type: none"> <li>- Liquefactions and dike injections</li> <li>- Landslides</li> <li>- Rock fall</li> <li>- Tsunamis/Seiches</li> <li>- Collapses in caves</li> <li>- Folded mortar pavements</li> <li>- Fractures, folds &amp; pop-ups on regular pavements</li> <li>- Fractures, folds &amp; pop-ups on irregular pavements</li> </ul>
	<p style="text-align: center;"><b>BUILDING FABRIC EFFECTS</b></p> <p><i>Strain structures generated by permanent ground deformation</i></p> <ul style="list-style-type: none"> <li>- shock breakouts in flagstones</li> <li>- Rotated and displaced buttress walls</li> <li>- Tilted walls</li> <li>- Displaced walls</li> <li>- Folded walls</li> </ul> <p><i>Strain structures generated by transient shaking</i></p> <ul style="list-style-type: none"> <li>- Penetrative fractures in masonry blocks</li> <li>- Conjugated fractures in walls made of either stucco or bricks</li> <li>- Fallen and oriented columns</li> <li>- Rotated and displaced masonry blocks in walls and drums in columns</li> <li>- Displaced masonry blocks</li> <li>- Dropped key stones in arches or lintels in windows and doors</li> <li>- Folded steps and kerbs</li> <li>- Collapsed walls (including human remains and items of value under the rubble)</li> <li>- Collapsed vaults</li> <li>- Impact block marks</li> <li>- Broken pottery found in fallen position</li> <li>- Dipping broken corners</li> </ul>
<b>II. SECONDARY EFFECTS (INDIRECT EFFECTS)</b>	<ul style="list-style-type: none"> <li>- Fires</li> <li>- Repaired buildings</li> <li>- Recycling anomalous elements</li> <li>- Settlement abruptly abandoned</li> <li>- Stratigraphic gap in the archaeological record</li> <li>- Flash floods generated by collapses of natural and human dams</li> <li>- Anti-seismic buildings</li> </ul>

Figure 9.1: Classification table of the Earthquake Archaeological Effects (EAE).

Figure 9.2 shows the map of the downtown area of Lorca, identifying the main EAEs. The symbols of the EAE are shown in Figure 9.1. The figures describe the main EAEs recognised and they have been created using the methodology of Giner-Robles et al., 2009.

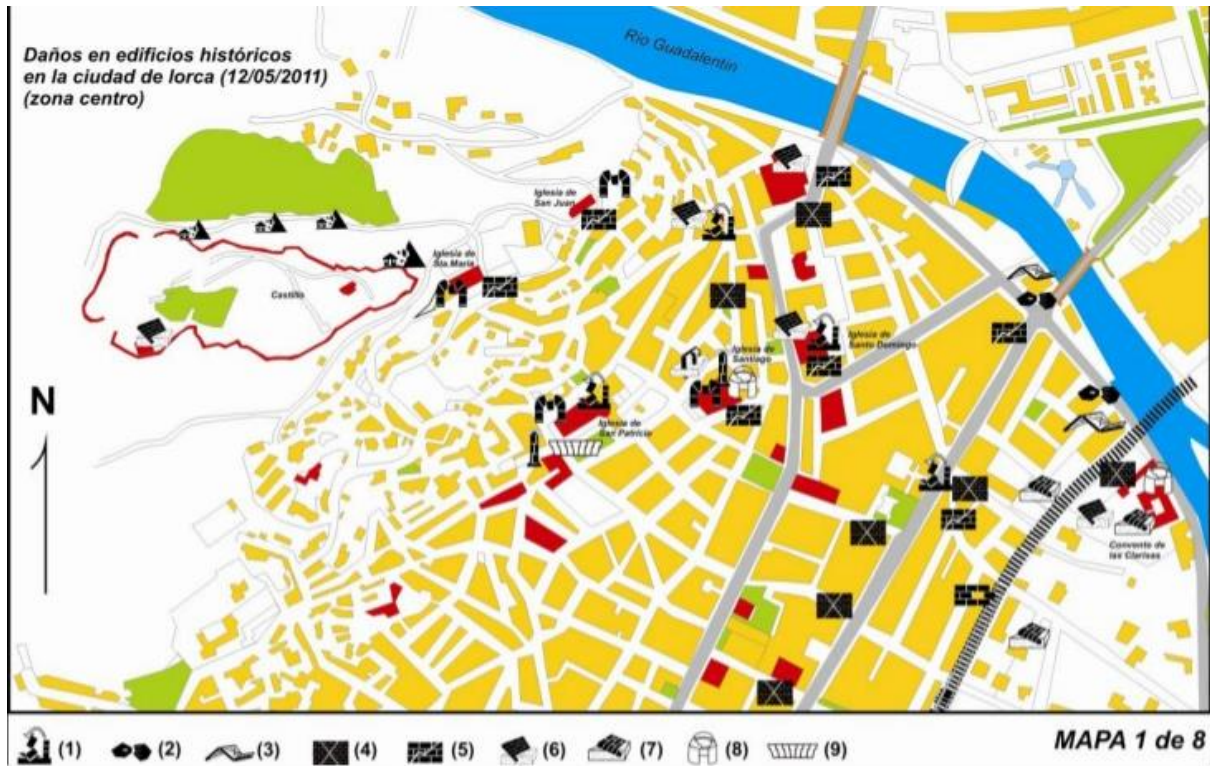

Figure 9.2: Map of downtown of Lorca, with the spatial distribution of the main EAEs classified during the field work after the earthquake. See figure 9.1 for further explanation of the symbols.

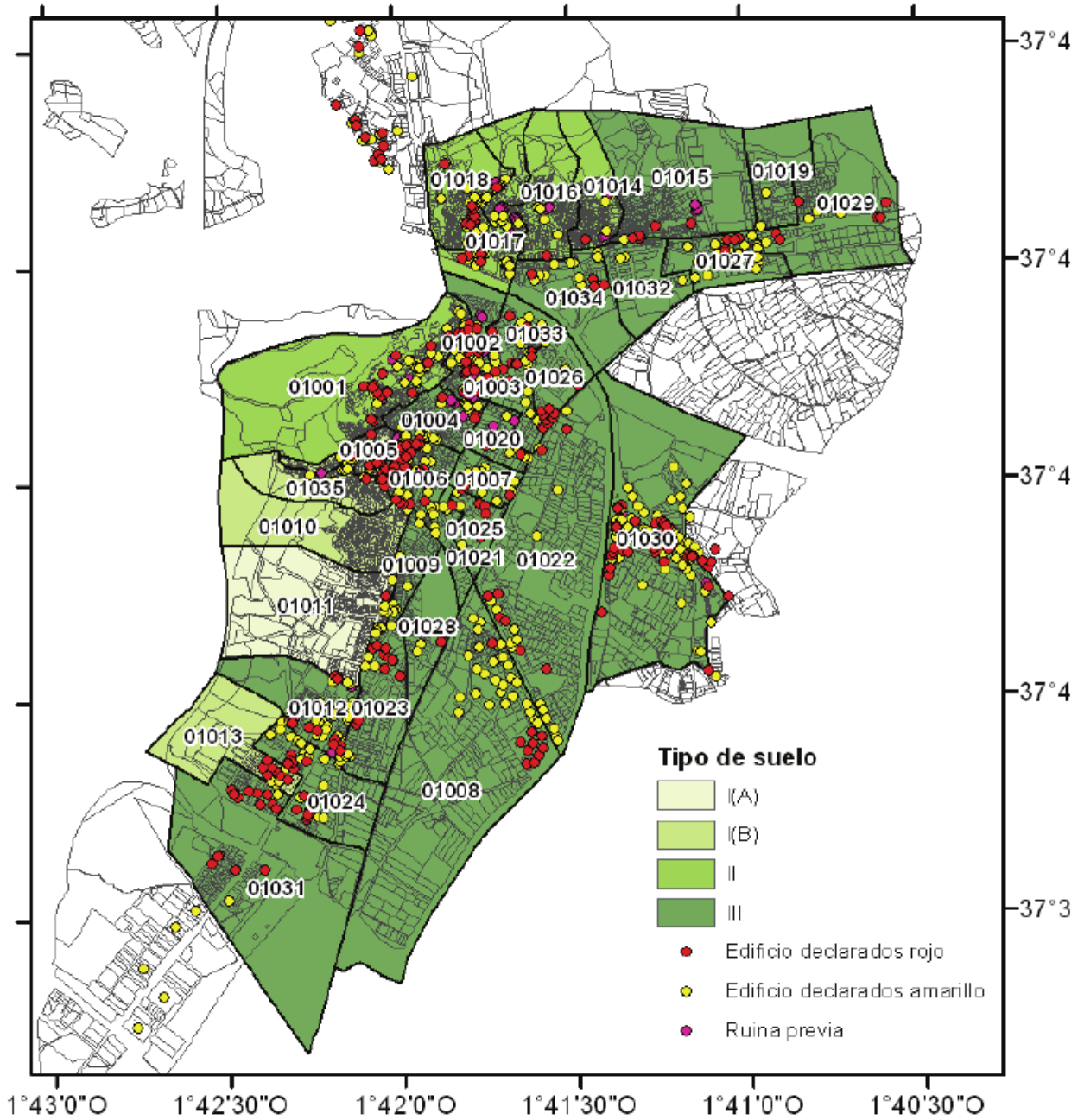

Figure 10: Damages in Lorca indicating buildings declared yellow (moderate damage) and red (serious damage) by census district and type of land with data from May 20. It also indicates those buildings that were already in ruins before the earthquake. The real estate park of the census area studied in this work is 5155 buildings (IGN).



## ***Damage to cultural heritage***

In the Guevara Palace it was possible to verify the situation of breakage of many movables by overturning. Some of the showcases were collapsed with all the ceramic elements of the interior, being the room most affected the dining room by the greater amount of pieces that it contained. Inside the infrastructures numerous cracks were visible in the interior load walls, with greater severity in those that make up the main staircase, causing the unbinding of the pieces of chairs with opening of the joints of the pieces. The movement of the slabs produced the lifting of the floor of great historical value in much of the surface of the rooms on the first floor. Likewise, the overturn of one of the tall showcases of the numismatic room, produced the dispersion throughout the room of all the pieces that they contained. The building of the Museum, the Salazar Rosso house, was also damaged in its structure, with greater importance in the expansion area of recent construction unlike the historic main body where sloping cracks were visible in load-bearing walls.

Of particular relevance were the damages in the Church of Santiago due to the complete ruin of the Church's transept, with the fall of the dome, vaults, arches and covered roofs. This collapse has represented one of the symbols of the impact that seismic movements have produced on the cultural heritage of Lorca. In the tower of the Church, there was the cracking of the walls and cornices on all four sides. The north end collapsed both inwards and outwards and in the central nave longitudinal and transverse cracks with separation of the former arches. In the "*Colegiata*", the seismic movements caused the fall of the loose elements in stone of the top of the tower, the buttresses and the main facade, originating in the case of the crowns of coronation of the tower, the perforation of the covers of the ambulatory and the breaking of the vaults in this area of the headboard next to the tower, with the pavement collapsing in the impact zone.

In the Baroque facade there was a partial break of the sculptures that crown it with a collapse towards the street, as it happened with some of the pinnacles of the buttresses. In the ambulatory, cracks of separation of vaults and closing walls were also visible, and the collapse of the NE closing wall with the overturning of its exterior face in ashlar masonry on the roof of this area, as well as the opening of new cracks in the vaults of the central ship and lateral.

The damages produced in the dome of the Chapel of the Rosary, with a sepulchral vault of two threads, consisted in the horizontal fracture of the same at the height of the upper area of the oculi. This strong horizontal cracking in the inner leaf following the quartering of the brick caused the loss of the pictorial decoration in this affected area.

In the dome of the "*Iglesia de Virgen de las Huertas*", the damage to the dome consisted equally in the horizontal cracking and loss of the mural paintings, and in the tower there was the collapse of the concrete structure of the dome. The breaking of the cupola of the Church of *San Francisco* was characterised by the loss of part of the hemispherical surface, and no paintings were affected. The most spectacular damages produced by the earthquake in historical structures were those that affected the "*Torre del Espolón*" in the "*Castillo de Lorca*", which consisted in the detachment and loss of the volume of





its coronation in its four faces with a strong displacement of the NW corner in the height of the tower, manifested in two large cracks that ran along both sides, with distances between factories ranging from 10 cm in the lower area and 40 cm in the upper area.

Inside, the displacement of the corner was also evident in the inner wall of the tower, where the separation between the base and the shaft of the starting column of the nerves of the vault of the first body was visible, as well as the separation and descent of the voussoirs to the height of the key, with strong cracking of the brick plinth. Injuries also occurred in the canvases of the walled enclosure of the Castle, with the complete collapse of one of the sections of the wall of the area next to the tower.

In the rest of the buildings of the cultural heritage, the generalised damages have consisted of numerous cracks in load-bearing walls, mainly in stairwells with separation of the taps and breakage of them in a perpendicular direction to the wall, collapse of the main facades towards the street with separation of the perpendicular walls and the forging of the slabs in the area close to the façade, as well as the collapsing of the cornices and loose elements of the balconies and the closing of the facades.

## 1.5. Detected pathologies relation

### *Interaction of structure and infill panel.*

According to (WHE 2006) the performance of buildings with masonry infill in the frame panels in past earthquakes has revealed that the presence of masonry infill walls is typically detrimental for the seismic performance of the building. The numerical simulation of whole buildings in their elastic and post-elastic ranges up to failure is even today quite challenging. Usually macro models are used when whole structures are analysed whereas micro models are only employed when laboratory tests of structural elements are simulated. When using macro models it should be remembered that these models are generally unable to capture some of the failure modes described in the following.

### *Failure of the beam-column junction.*

Joints are usually critical points in structures and many efforts have been put into the study of its behaviour. The importance of an adequate design is widely recognized however, quality control during construction is also very important. Construction joints in columns are usually located at the undersides of the slabs and beams as shown in Figure 13.

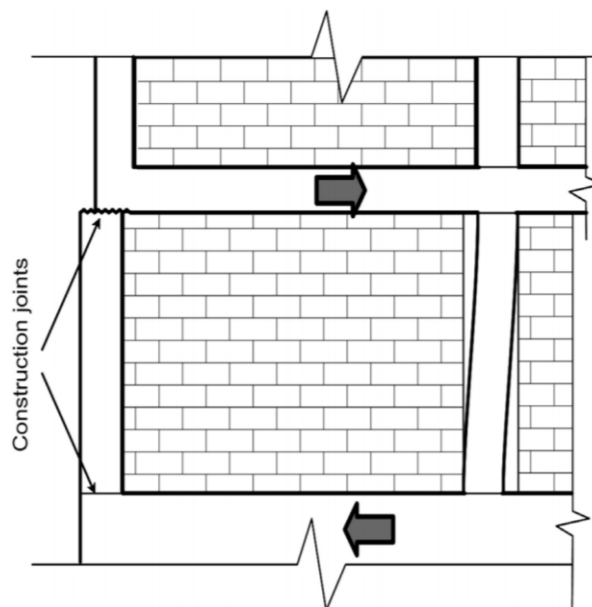

Figure 13: Failure at the construction joint of beam-column connection.



Figure 14. Examples of failure at the construction joint of a beam-column connections.

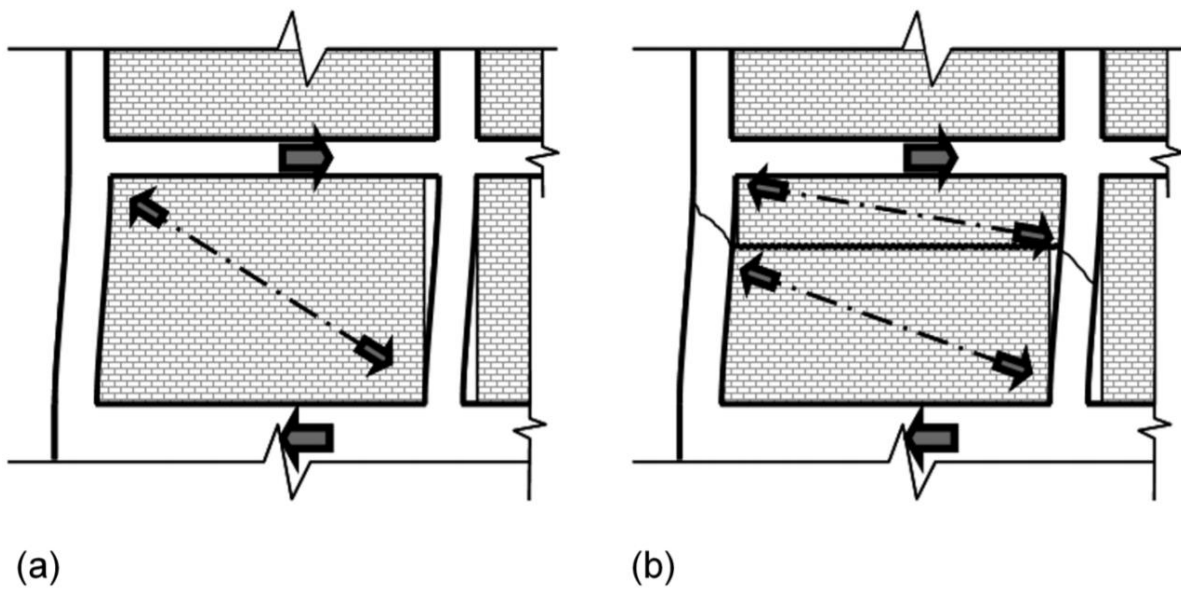

Figure 15. Force transmission before (Fig. 15 a) and after (Fig. 15 b) shear failure of the infill panel.

### ***Failure of the column and the infill panel.***

In general crack propagation in the infill panels indicates the position of the traction diagonal that connects two beam-column connections however, in some cases the cracks in the infill panels developed laterally displaced crossing the column at mid height like in Figure 16 b.



(a)



(b)

Figure 16: Example of cracks crossing a column at mid-floor height. Building (Fig. 16 a) Detail (Fig. 16 b).

### ***Failure patterns of non-structural masonry walls.***

After the earthquake a damage assessment was performed revealing that most of the damage may be classified as well-known failure modes due to the interaction between the frame structure and interior partitions or façade elements. A distinction of these failure modes may be drawn depending on whether the initial combination of the lateral resistive elements is responsible or whether the progressive failure of some of them and the accompanying change of the stiffness distribution leads to an excessive seismic demand. The following 5 bullet points belonging to the first group have been observed in Lorca.

1. Some buildings didn't seem to have effective mechanisms to resist lateral loads. However, most of them did not suffer excessive damage. In these cases the stiffness of the masonry infill panels add to the one of the frame structure and the infill panels resisted quite well. The damage distribution was similar to the one observed in buildings with an effective lateral load resistance mechanism.
2. Asymmetrical horizontal stiffness distribution leading to torsion moments. This was quite often the case in corner buildings of apartment blocks. The only building that collapsed during the earthquake falls into this category. Other



corner buildings with asymmetrical horizontal stiffness distribution suffered substantial damage.

3. Soft storey mechanisms due to infill panels with lower stiffness at the ground floor level and panels with higher stiffness at upper floors. In many cases the interstorey height at ground floor level was significantly higher than that of the upper floors favouring thereby the generation of a Soft storey mechanism.
4. Masonry infilling effect on frame columns. The horizontal displacements of the frame columns are restricted due to the presence of the masonry wall. The reduced height of the column increases the forces the column experiences during a seismic event.
5. Shear force concentration in combined systems consisting of R.C. columns and masonry shear walls. In order to estimate realistic shear forces during the design phase it is crucial to take the stiffness of the masonry wall into account however, quite often infill panels are not considered in the structural building model that is used for the seismic response analysis. It is quite common that only one infilled bay exists at ground level. In this case the infill is usually part of the elevator core walls.

A progressive failure of the infill panels or the frame columns and the accompanying change of the stiffness distribution is thought to be responsible for the following 2 failure patterns observed in Lorca.

1. Formation of soft storey mechanisms due to the progressive degradation of the infill panels located at ground floor levels.
2. Column failure due to interaction forces between the masonry walls and the RC columns. The adjacent frame columns are usually not designed considering different failure modes of the masonry walls and the resulting force redistribution.

### ***Column failure.***

The interaction between the infill panels and the surrounding frame structure during a seismic event is an active research topic and quite challenging to simulate. At the design stage of many of the existing buildings in Lorca, however, this interaction was taken into account only approximately if at all. As a consequence the columns i.e. the most important structural elements for gravity loads are subjected to loads that they were not designed for. In this context, it is worth to remember that according to (NEHRP 2008) column shear failure is the most frequently cited cause of concrete building failure and collapse in earthquakes!

Depending on the failure mode of the infill panel different types of loads at different locations act on the columns. In many cases the resistance of the infill panels is small enough so that the forces that have to be transferred to the frame structure can be supported without any problem. However, there is still the problem of the significant falling hazard related to a damaged infill panel. The situation is different if the infill panels are capable of supporting high loads. Due to the high in plane stiffness of the

masonry infill the forces that have to be redistributed i.e. transferred from the infill to the frame structure are very important. In addition, the load redistribution occurs very rapidly and this fact contributes to the generation of brittle failures of columns. Today's design criteria (EN1998-1 2004) as well as standard text books on the seismic design of reinforced concrete and masonry buildings like insist that brittle failures of structural elements shall be avoided.

In very few cases the frame structure failed whereas the infill panels were intact after the earthquake. In some cases both the frame structure and the infill panel showed similar resistance values so that the origin and sequence of failure could not exactly be identified.

As an example, suppose a concrete column with square cross section of 40 x 40 cm and a compressive strength of 25 MPa (5% cylinder strength  $f_{ck}$ ) that is reinforced with 3 bars of diameter 16 mm on each face subjected to an axial load that results in an average compressive stress of 5 MPa. In Figure 11 the corresponding moment-curvature diagram is displayed.

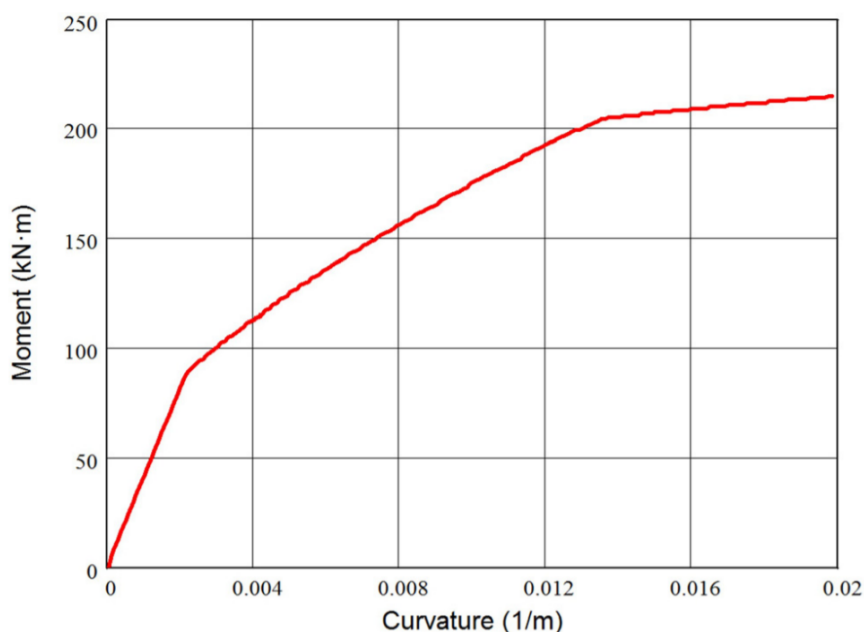

Figure 11: Moment-curvature diagram of the compressed column.

The maximum value reaches 215 kNm. Based on equilibrium considerations of the capacity design method, see Figure 8, and considering a floor height  $h$  of 4 m, the corresponding maximum shear force is 107.5 kN.

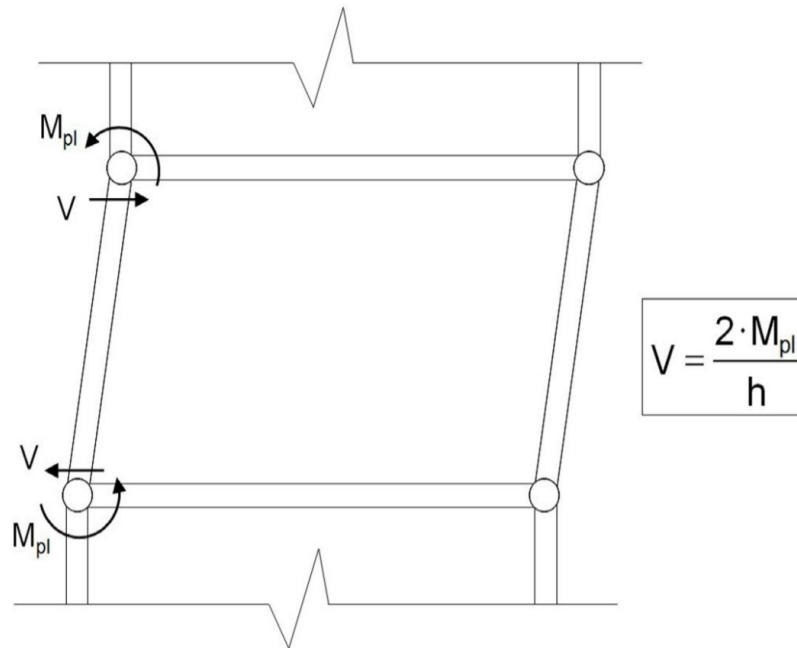

Figure 12. Estimation of the shear demand in a column.

The shear capacity of this column without shear reinforcement is according to the Spanish Seismic Design Code (NCSE 2002) 182.5 kN. Considering the same limit values for the maximum moment and the shear capacity of the column a floor height of 2.36 m would be necessary to increase the shear demand to an extent that the shear capacity is exceeded when reaching the maximum moment. However, this floor height is much lower than the limit value established by the urban building standards. This means that, in general, a column shear failure may be avoided if the capacity design approach is followed and properly detailed shear reinforcement is designed and provided. In the following section the interaction between frame structure and infill panels will be further discussed.

### ***Shear failure of the infill panel.***

This type of failure is particularly dangerous because of the damage that is caused to the compression zone of the infill panel i.e. the load carrying strut in an equivalent strut model. If the failure results in the formation of two struts like indicated in Figure 15 b important forces act on the column sections almost at mid-floor height. The formation of two struts may be favoured by the existence of conduits, openings or other discontinuities in the infill panel.



## 1.6. Guide parameters

- *Alhama de Murcia* Fault is the fault with greater evidence of Quaternary activity in the area, with evidence of paleoseismic activity ( $M > 6.0$ ) over the last 1000 years, associated with thermal springs and a well-recognized surface trace. There was destructive historical seismicity located along the trace during the XVII, XVIII and XIX centuries. FAM has a clear geomorphological expression in this area and whose trace is parallel to one of the nodal planes of focal mechanisms obtained for the earthquakes of May 11, 2011. The sinistral strike-slip movement of the fault is consistent with the focal mechanism solution.
- The high seismic intensity experienced by the town of Lorca (intensity VII EMS-98 scale, data IGN) associated with a magnitude 5.1  $M_w$ , may be due to the earthquake spread from the “*Sierra de la Tercia*” (epicentral area) to the SW. The lack of geological effects towards the east of the epicentre supports this possible directionality of propagation.
- The wave propagation supports the directionality of the FAM rupture spread from the epicentral area, crossing the city of Lorca. This reason associated with the shallowness of the earthquake, would explain the high seismic intensity and peak accelerations of 0.36 g (IGN data) recorded in the accelerometer of the old prison of Lorca (located in the downtown).
- The increasing in static stress (Coulomb Stress - Transfer Model) on the segments of the *Alhama de Murcia* Fault generated by the main earthquake may have increased the likelihood of earthquake occurrence in these areas. However, it is not possible specify temporary occurrence of these earthquakes.
- The orientation of the principal axe of the strain ellipsoid ( $e_y$ ), obtained from the archaeoseismological study is NW-SE, is consistent with the regional tectonic stress field and focal mechanism of the main earthquake and also with the epicentral location.
- The archaeoseismological data (more than a hundred values) suggest an origin of the deformation associated with a nearby seismic field, implying that most of the main earthquake rupture occurred beneath the historic city of Lorca because the faulting subsurface rupturing runs below the Lorca village.
- With these data and their inclusion in the Environmental Seismic Intensity Scale ESI07, this preliminary geological report will improve the information of historical earthquakes and epicentral location, improving the knowledge of the seismic process in Spain.





## **2. General information drawings**

***The Seismoresistant Construction Regulations NCSE-02 (Mapa de peligrosidad de la norma sismorresistente NCSE-02).***

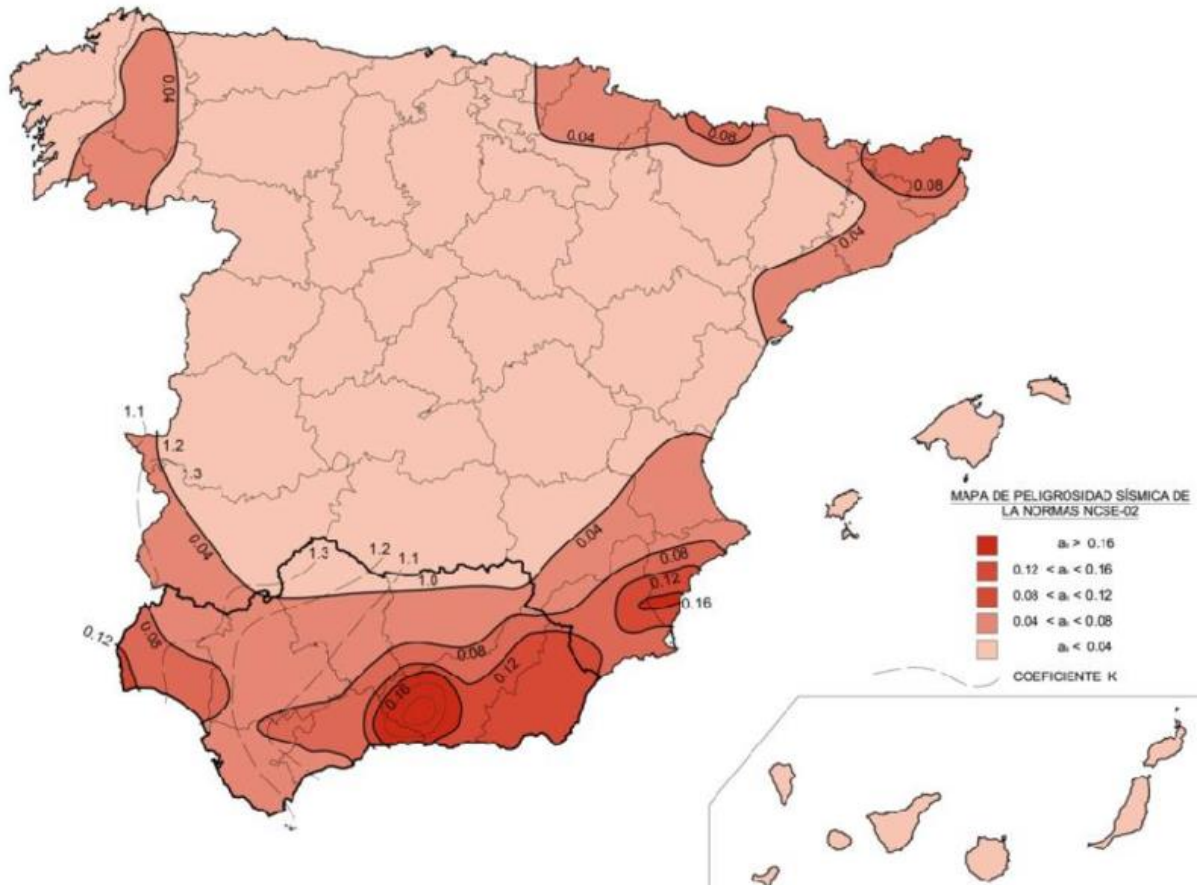

**Macroseismicity map of eastern Betics with the main Neogene faults. Indicated fault movements correspond to late Neogene. CRF, Crevillente fault; AF, Alhama de Murcia fault; CF, Carrascoy fault; PF, Palomares fault; CF, Carboneras fault.**

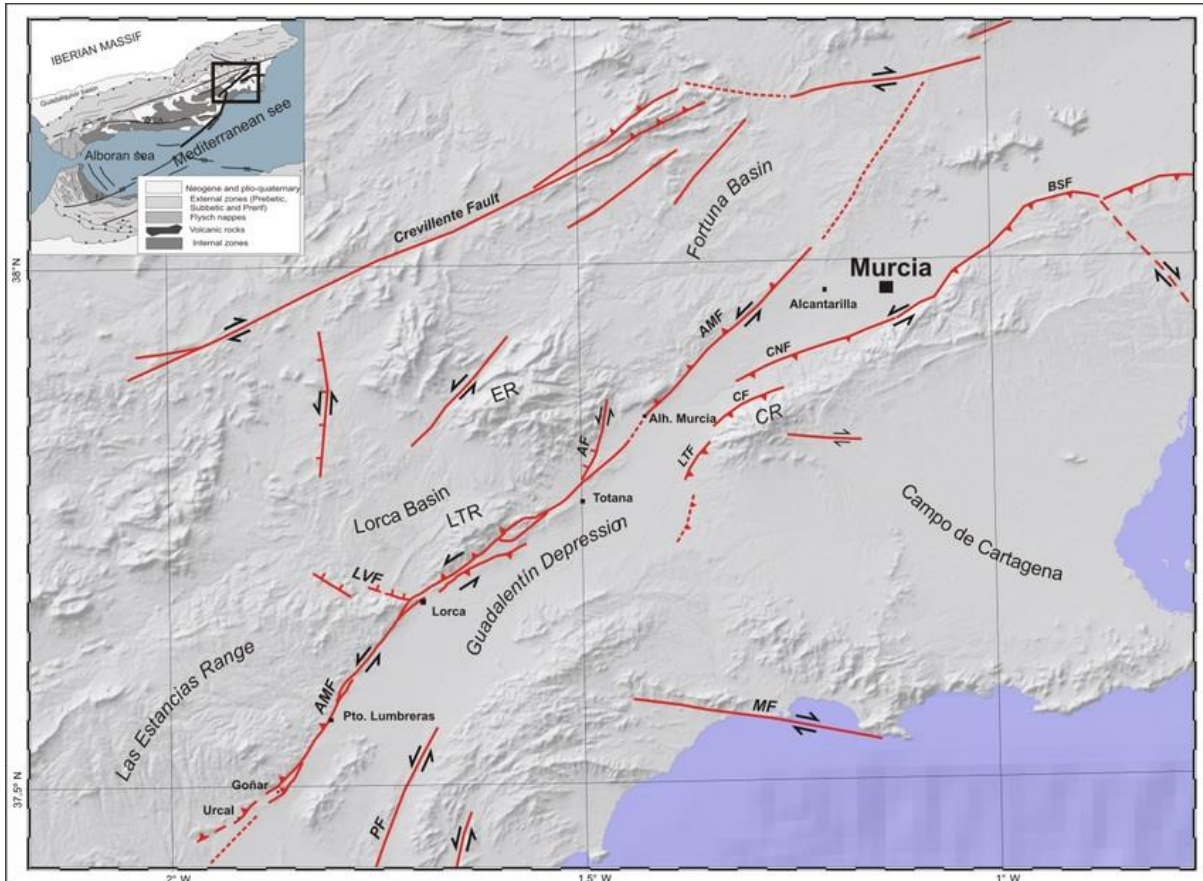

*Map of the trace of the FAM. The triangles represent the historical seismicity of Intensity > VI.*

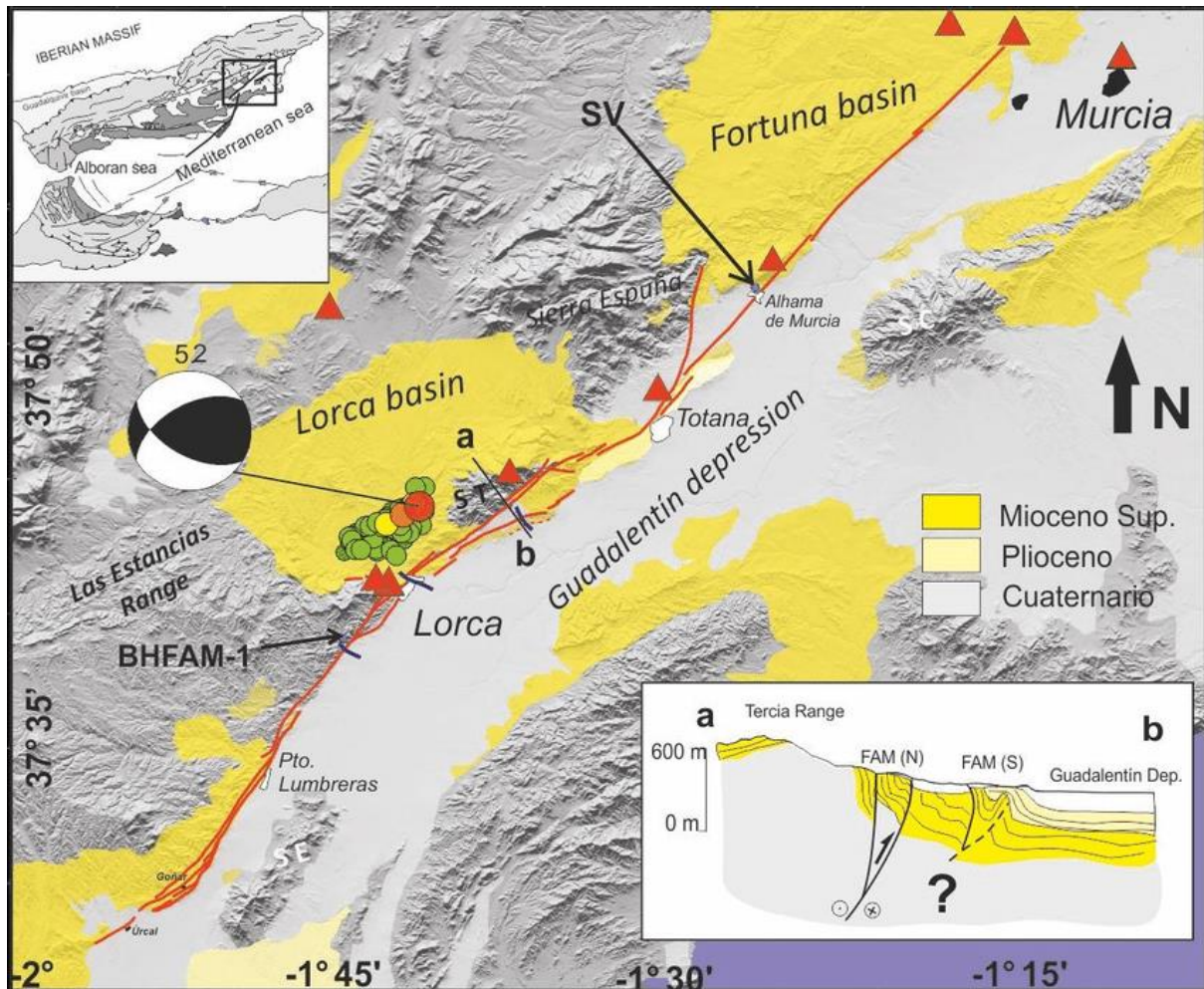

## *Lorca region.*

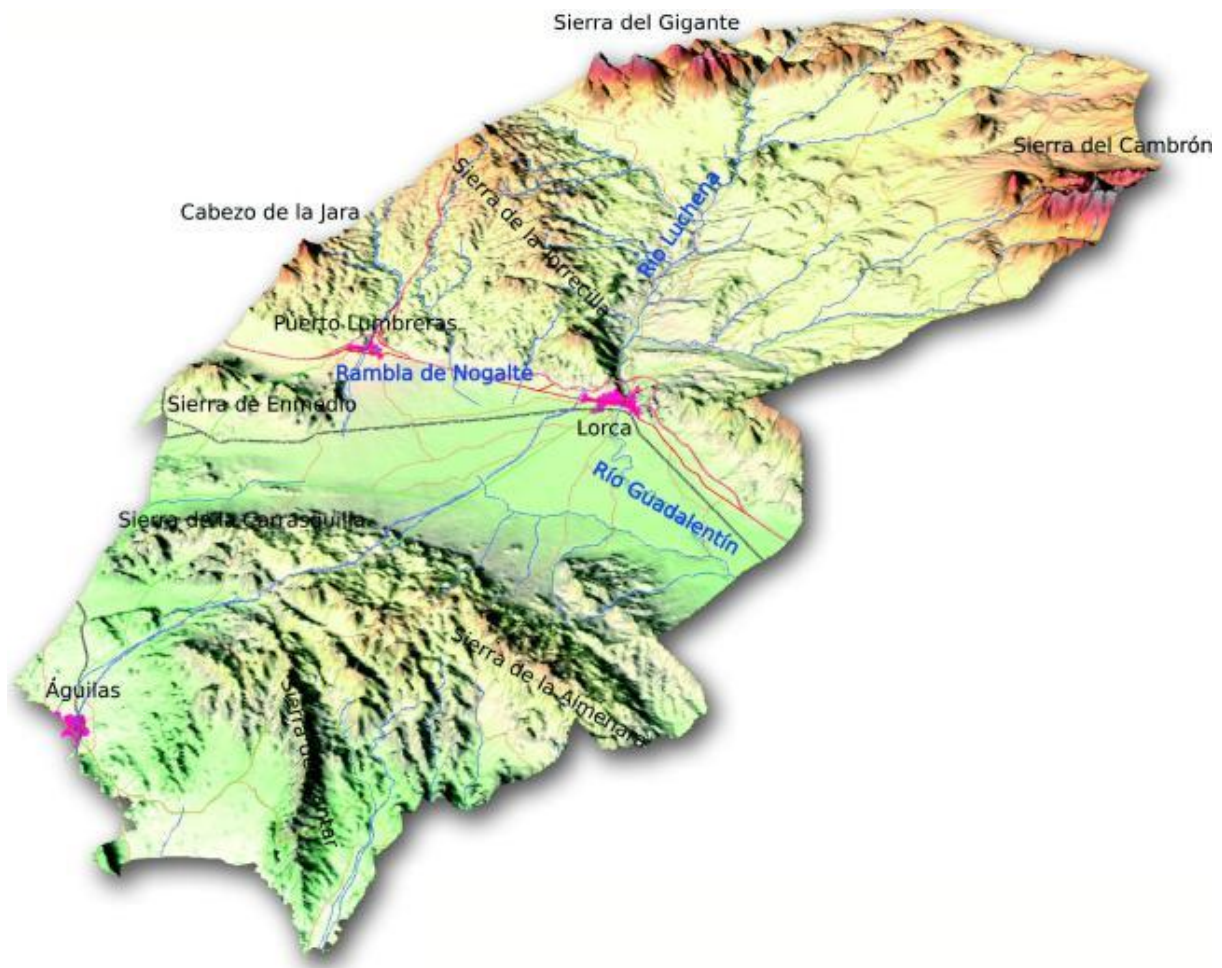

Lorca is a municipality and city in the autonomous community of Murcia in southeastern Spain, 58 kilometres (36 mi) southwest of the city of Murcia. It had a population of 478,956 in 2010, up from the 2001 census total of 399,567. Lorca is the municipality with the largest surface area in Spain with 1,675.21 km<sup>2</sup> (646.80 sq mi). The city is home to Lorca Castle and the Collegiate church dedicated to St. Patrick.

In the Middle Ages Lorca was the frontier town between Christian and Muslim Spain. Even earlier to that during the Roman period it was ancient Ilura or Heliocroca of the Romans.

The city was seriously damaged by a magnitude 5.1 earthquake on 11 May 2011, killing at least nine people. Due to shallow hypocenter, the earthquake was much more destructive than usual for earthquakes with similar magnitude.

*Soil classification and general structure.*

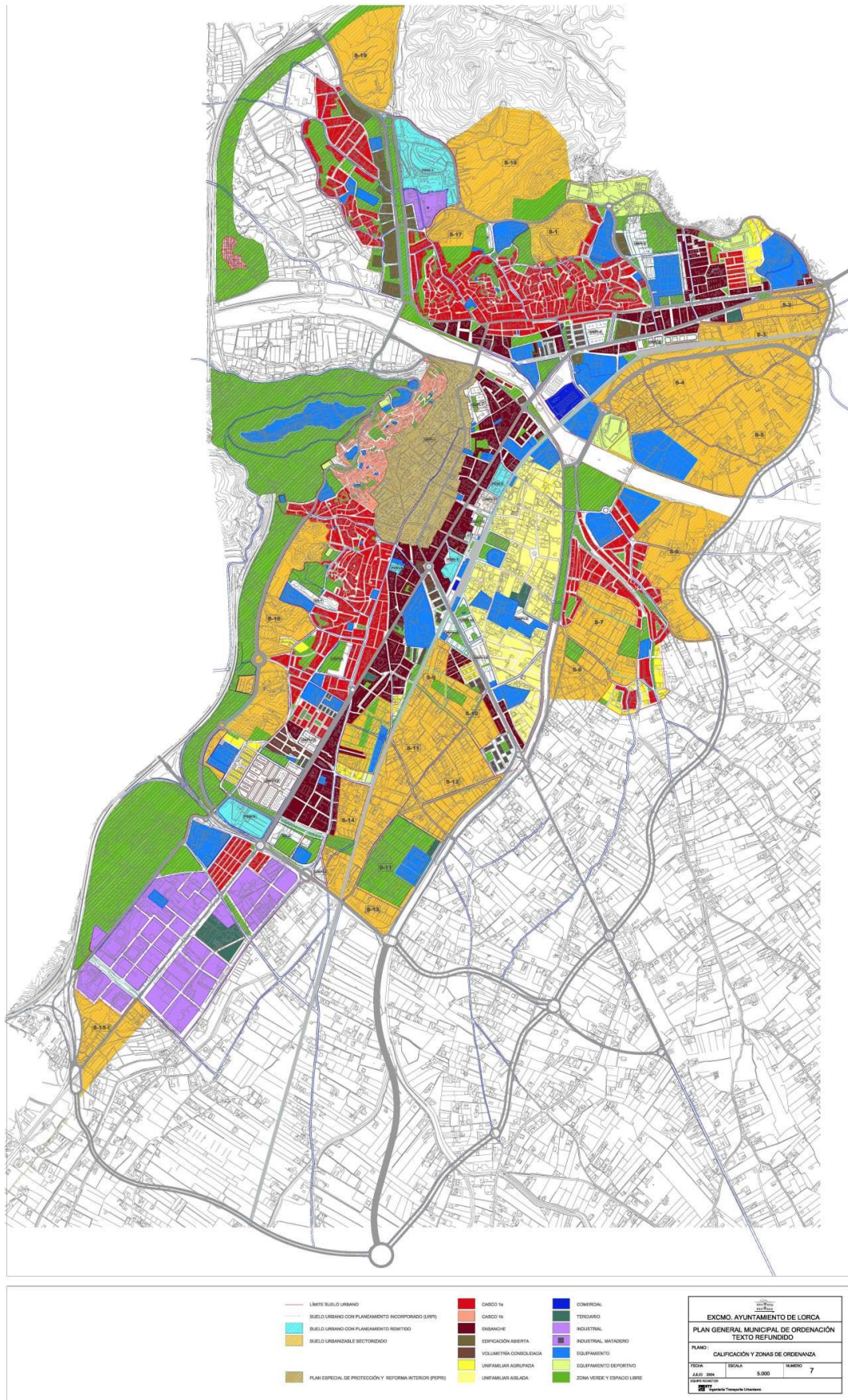

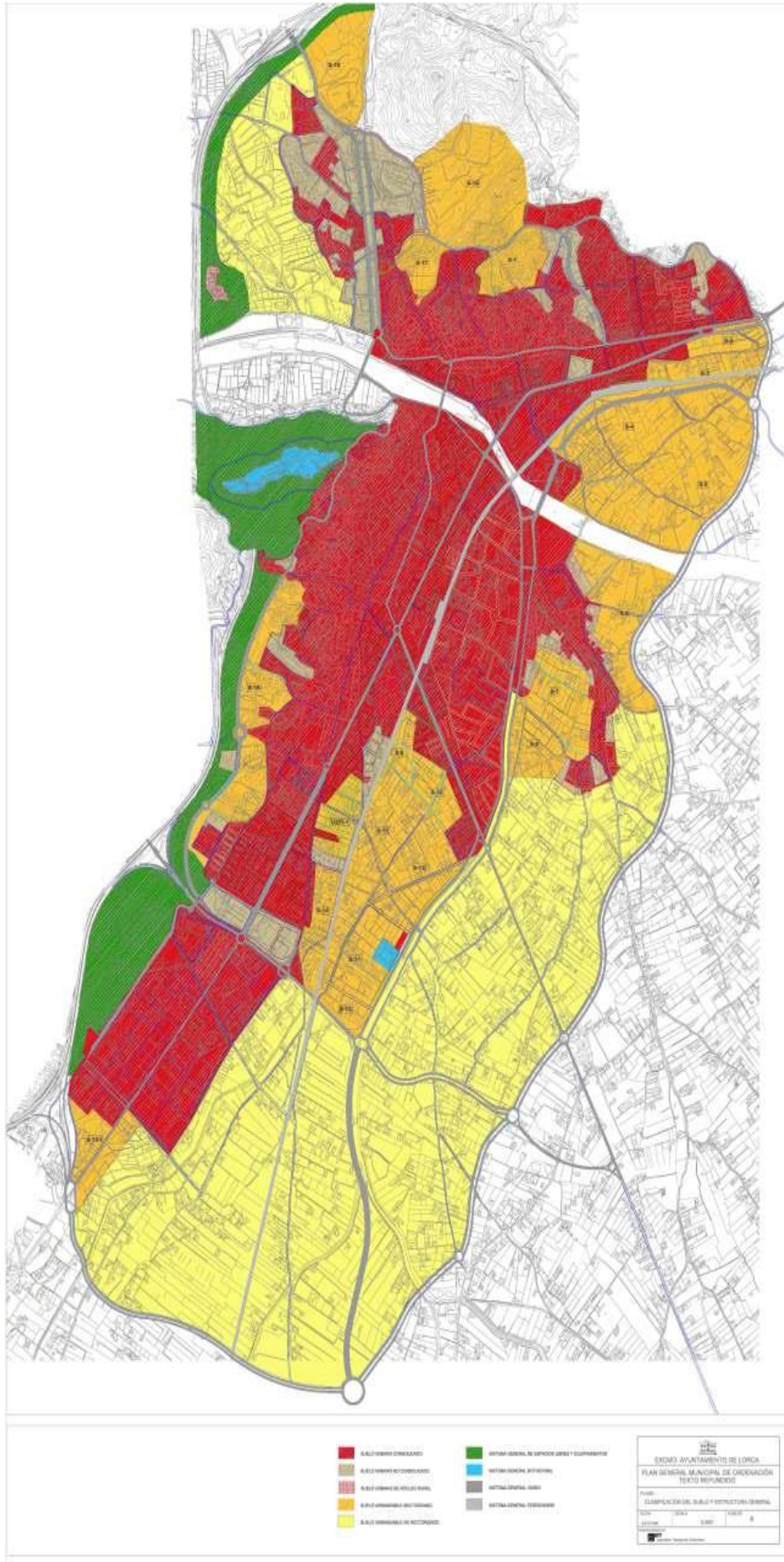



### *Affected districts.*

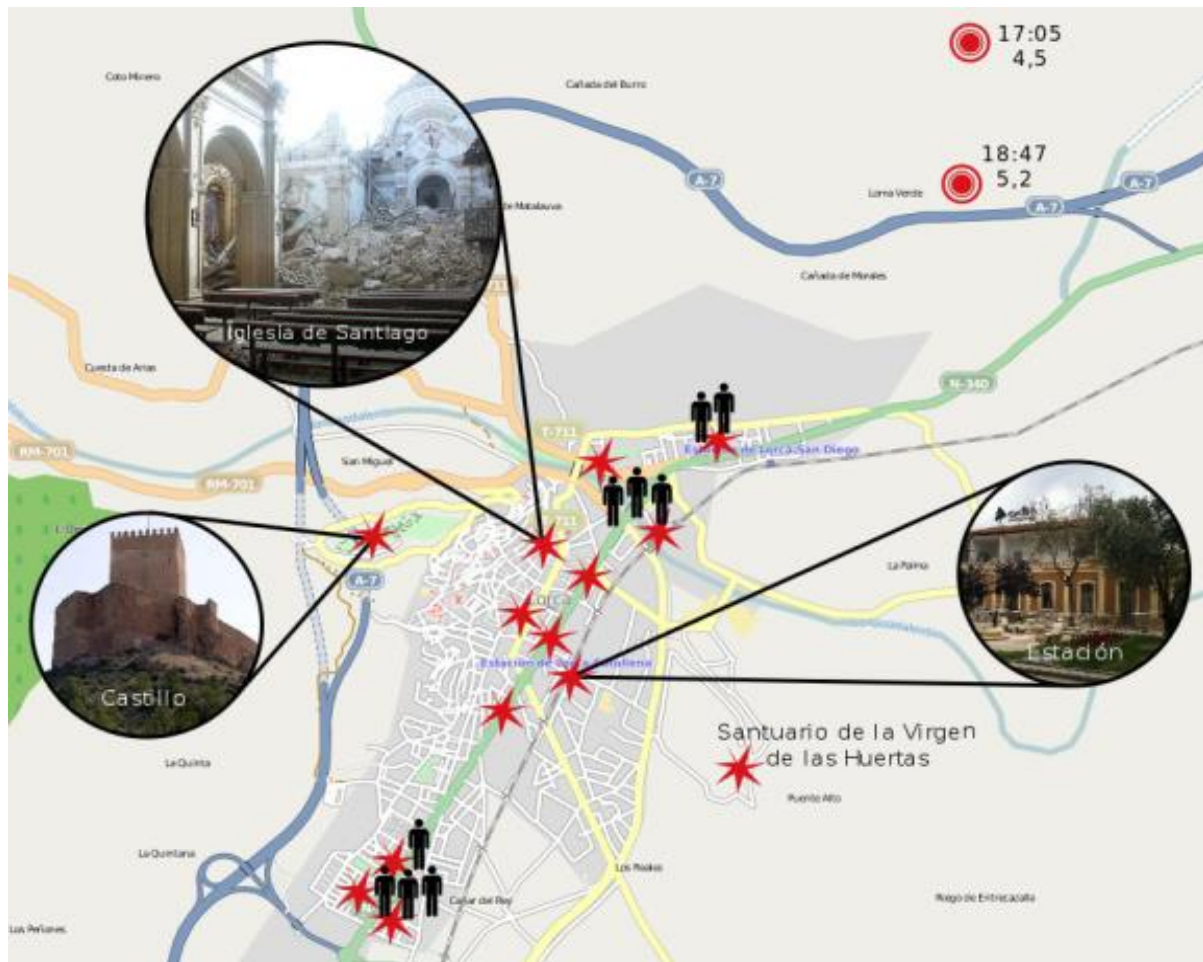

Shortly after the second earthquake struck, the Spanish government, at the request of regional government of Murcia, activated the Military Emergencies Unit, a branch of the Spanish Armed Forces responsible for providing disaster relief. 340 members from three battalions (based at Bétera, Torrejón de Ardoz and Morón de la Frontera) were dispatched to Lorca under the management of the Lieutenant Colonel of the Bétera battalion; these were later joined by army units. A field hospital was set up by the Military Emergencies Unit in the Plaza del Ayuntamiento where those injured were attended to by members of Protección Civil and the Red Cross.

## *Public and historical buildings affected by the earthquake.*



The damage caused by the seismic series of 2011 (and by the one of 1674) show the historical building vulnerability against seismic actions. The historical buildings damages are directly related to the different typologies, the structural complexity, and the conservation and maintenance state, finding cases of a very different nature. This has conditioned different responses to the earthquake, for instance, the response of the big walls built with different materials and heterogeneous constructive systems.

The historical civil buildings having a structural organization with walls in the two directions or a dense compartmentation with structural and non-structural elements have been less vulnerable than the religious buildings. The damages show the heterogeneity of their stones. Many damages to the joints were caused by a lack of connection or by a discontinuity of the constructive elements. In many cases, the damages were due to inadequate alterations that have unbalanced the structure of the constructions. The stair cores have been particularly affected, since they are points of structural discontinuity. (PDRPCL, 2011).

The analysed Heritage buildings are mostly structures of load-bearing walls made of brick or uncut stone, with ashlar reinforcements in the corners and around the wooden hollows and framework. This type of buildings has got a low ductility. Due to their stiffness they have got high vibration frequencies that make them very vulnerable to close earthquakes (with large high frequencies content). This, added to the lack of

connection between the structure vertical and horizontal elements, the geometry and the high weight of the construction materials, has provoked a generalized damage in this type of buildings.

The churches have been the more affected heritage buildings, particularly their towers, and elements such as arches, vaults, domes and roofs. Most of the towers have been seriously damaged. During the second earthquake, the bell towers of the church of San Diego and the sanctuary of Virgen de las Huertas collapsed. Apart from these, the towers of the chapels of Rosario, Santo Domingo, San Francisco, Santiago, San Juan and Santa Maria were seriously damaged and they needed provisional emergency measures (clamps) to prevent their collapse during the aftershocks. Although the towers of San Mateo, San Cristobal, Santa Maria, Nuestra Señora del Carmen and San Pedro were not on the point of collapse, but they suffered shear cracks. The palatial buildings were less affected than the Churches, a fact that may be related to their geometry, weight and smaller size.





## **3. Analysis**

### 3.1. New evaluation techniques for information and aftershock management

An important aspect to consider after an earthquake is that damage evaluation provides homogeneous information of the affected area. There are, however, usually distorting variables (capacity of the evaluators, subjectivity, information management, etc.) as we can see from acquired experience (Table 2).

	Turkey (1999)	Colombia (2009)	Chile (2010)
<b>GREEN (safe, usable or habitable)</b>	Little or no structural damage. Temporary occupation allowed.	Low risk for global stability, geotechnical problems, structural damage and / or non-structural damage.	No damage or very limited on the whole. No restrictions on use.
<b>YELLOW (caution, restricted entry or temporary disablement, dubious safety)</b>	Damage to structural and / or non-structural elements. Temporary occupation not allowed, except for emergencies.	Low risk, after measurements, global stability, geotechnical problems, structural damage and / or non-structural damage.	Damage, structural or non-structural sufficient for controlled risk to people. Partial closure and limited entry.
<b>ORANGE (unhabitable)</b>	Not specified.	High risk for global stability, geotechnical problems, structural damage or non-structural damage	Not specified.
<b>RED (risk, unsafe or disablement)</b>	Significant risk of collapse with aftershocks. Entry not allowed. Measures to prevent sudden collapse.	High risk for at least two (or very high for at least one) of the following reasons: global stability, geotechnical problems, structural damage, and non- structural damage.	Elevated damage involving high risk of injury to persons. The building should be closed.

Table 2: Damaged building classification categories.

In the case of the Lorca earthquake no lives were lost due to the structural collapse of a building or infrastructure. Most of the material damage was associated with wrong urban configurations or little care in the construction details, with the most common structural pathologies being phenomena such as soft plant, short pillars or poor design in reinforced concrete. Based on the experience gained in this earthquake, the UPCT has proposed a quick aftershock assessment form to ensure safety [1]. The building located in the Aprendices Square had an unexpected collapse during its demolition due to the damage on the ground floor and first floor (Fig. 17). It had, according to its evaluator, only serious damage in facades and the fall of part of the breastplate housing, causing the financial ruin of the building.



(a)



(b)



(c)

Figure 17: Building in danger of collapse. Evidence of crashes in (a) joint between buildings and (b) corner pillar. (c) Collapse.

According to the proposed form, this building would be a level 4 (very high) estimated risk of loss of global stability and level 2 (moderate) non-structural risk. Therefore, it would be classified as a potential collapse (black colour), as it has at least one level 4 classification (Fig. 18).

Formulario de Evaluación Urgente Post-sismo de Edificios 

**SECCIÓN 1. IDENTIFICACIÓN EDIFICIO Y HABITABILIDAD**

Zona / Barrio: \_\_\_\_\_ Nombre edificio: \_\_\_\_\_  
 Calle / Avda.: \_\_\_\_\_ Nº \_\_\_\_\_

Resumen clasificación de la habitabilidad (copiada de la Sección 5 al finalizar)

VERDE (habitable)  AMARILLO (uso restringido)  ROJO (no habitable)  NEGRO (peligro de colapso)

**SECCIÓN 2. INSPECCIÓN Y DESCRIPCIÓN DEL EDIFICIO**

Exterior e interior  Sólo exterior  Parcial  Fecha: \_\_\_\_\_ Hora: \_\_\_\_\_

Señalar uso predominante del edificio:  Residencial /  Comercial /  Docente /  Sanitario /  Hotelero /  Administrativo /  Industrial /  Aparcamiento /  Otro

Señalar uso predominante planta baja:  Residencial /  Comercial /  Docente /  Sanitario /  Hotelero /  Administrativo /  Industrial /  Aparcamiento /  Otro

Superficie (aprox.): Largo (m) \_\_\_\_\_ Ancho (m) \_\_\_\_\_ Nº de plantas sobre el terreno: 5 Nº sótanos: 1

Estructura (pórticos de hormigón, de acero, etc.): Estructura apuntalada de hormigón armado

Forjado (viguetas de hormigón, acero, madera, reticular, etc.): Unidireccional de viguetas prefabricadas

Señalar año de construcción: 1. Anterior a 1963 2. 1963 a 1968 3. 1969 a 1974 (si se conoce) 4. 1975 a 1994 5. 1995 a 2002 6. Posterior a 2002

**SECCIÓN 3. DAÑO Y RIESGO ESTRUCTURAL**

RIESGO estimado de pérdida de ESTABILIDAD GLOBAL del edificio:

NIVEL 1: BAJO  NIVEL 2: BAJO TRAS REFORZAR  NIVEL 3: ALTO  NIVEL 4: MUY ALTO

No existen colapsos, desplomes ni asentamientos en cimentación. No precisa reforzar.

No existen colapsos, desplomes ni asentamientos en cimentación. Precisa reforzar (apuntalamientos, apoos, etc.)

Colapso parcial (< 50 %) sin evidencias de desplomes en el resto, y/o existencia de asentamientos leves en cimentación

Colapso generalizado (> 50 %) o parcial (< 50 %) con evidencias de desplomes en el resto, y/o existencia de asentamientos notables en cimentación

DAÑO observado en PILARES y VIGAS (planta más dañada):

NIVEL 1: LEVE No se aprecian daños o existe fisuración leve (ancho < 1 mm)

NIVEL 2: MODERADO Agrietamiento leve (ancho entre 1-2 mm) en al menos el 40 % de pilares o vigas

NIVEL 3: FUERTE Agrietamiento notable (ancho > 2 mm) y barras expuestas en al menos el 20 % de pilares o vigas

NIVEL 4: SEVERO Daños graves (aplastamientos del hormigón, agrietamiento del núcleo de la sección, barras pandeadas, inclinaciones excesivas, etc.) en al menos el 10 % de pilares o vigas

PILARES  VIGAS

(a)

**SECCIÓN 4. DAÑO Y RIESGO NO ESTRUCTURAL**

DAÑO observado en elementos no estructurales:

	NIVEL 1: LEVE	NIVEL 2: MODERADO	NIVEL 3: FUERTE
Elementos en cubierta (antepechos, parapetos, cornisas, cornisas, etc.)	—	<input checked="" type="checkbox"/>	—
Elementos de fachada (comarciones, reves, vidrieras, cerramientos estructurales, etc.)	—	<input checked="" type="checkbox"/>	—
Tabiquerías y particiones interiores	—	—	—
Falsos techos	—	—	—
Escaleras	—	—	—

RIESGO estimado no estructural (función del daño observado):

NIVEL 1: LEVE No existen caídas o hay caídas leves. No hay peligro para las personas

NIVEL 2: MODERADO Daños concentrados que implican peligro para las personas. Adaptar medidas (restringir paso, cerrar, reforzar, etc.)

NIVEL 3: FUERTE Daños generalizados que implican peligro para las personas

**SECCIÓN 5. CLASIFICACIÓN DE LA HABITABILIDAD**

Riesgo de estabilidad global (copiar nivel de riesgo de Secc. 3): Nivel 1: Bajo  Nivel 2: Bajo tras reforzar  Nivel 3: Alto  Nivel 4: Muy alto

Daño en pilares y vigas (escoger el mayor daño de Secc. 3): Nivel 1: Leve  Nivel 2: Moderado  Nivel 3: Fuerte  Nivel 4: Severo

Riesgo no estructural (copiar nivel de riesgo de Secc. 4): Nivel 1: Leve  Nivel 2: Moderado  Nivel 3: Fuerte

Clasificación de la HABITABILIDAD (señalar la más restrictiva y copiarla después en la Sección 1):

VERDE (habitable) Si los tres clasificados anteriores son Nivel 1

AMARILLO (uso restringido) Si existe al menos una en Nivel 2

ROJO (no habitable) Si existe al menos una de Nivel 3

NEGRO (peligro de colapso) Si existe al menos una de Nivel 4 o más de una de Nivel 3

**SECCIÓN 6. DATOS DE CONTACTO Y COMENTARIOS**

Persona de contacto del edificio: \_\_\_\_\_ Tlf.: \_\_\_\_\_

Coordinador del equipo evaluador: \_\_\_\_\_ Tlf.: \_\_\_\_\_

Comentarios: \_\_\_\_\_

(b)

Figure 18: Building with danger of collapse. Completion of the proposed form. (a) Front. (b) Back. (Source: Tomás and Díaz, E. [1]).



## **3.2. The territorial management perspective in the analysis of the seismic vulnerability of cities.**

After the 2011 earthquake the Region of Murcia has launched certain planning measures in order to eliminate seismic vulnerabilities of its territory. In order to be prepared against a possible new earthquake it has accelerated the SISMIMUR plan update [2] by the Emergency Department. This plan specifies the seismic hazard, estimates vulnerability, the seismic risk in terms of damage and produces a catalogue of risk factors for buildings of particular importance that are located in areas where the intensity can be equal to or greater than VII for a return period of 475 years in the Region of Murcia.

In the same direction, another interesting measure to qualify the level of the available staff for the building design has been to start developing seismic strategy guides from the Ministry of Works and Planning of Murcia. These technical documents establish clear rules of seismic design for the reconstruction of buildings and provide rapid aftershock assessment protocols with standardized forms [3].

At a local level, a strategic action to prepare the city of Lorca for a possible new earthquake lies in adequate planning. Lorca is a city under reconstruction and in continuous urban growth (Fig. 19).

In this sense, the project commissioned by the Ministry of Works and Planning of Murcia to the Technical University of Cartagena of microzoning Lorca is very interesting. This is a standard procedure in cities with a seismic tradition such as Tokyo, Bogota or Santiago de Chile, but is a pioneering project for this size in Spain. The above-mentioned microzoning is now being addressed from a holistic and multidisciplinary perspective that is able to combine fields of knowledge such as seismic, geological, geotechnical or structural engineering. It will also cover innovative areas such as territorial planning and land use, after detecting in the 2011 earthquake phenomena associated with topography, urban growth in undue environments risk or the urban configuration of buildings in an earthquake.

After the earthquake of May 11, there were some voices that postulated the possibility of modifying the existing seismic code (NCSE-02 for buildings) due to the acceleration of 0.369 g achieved in an environment where the norm envisages just 0.12 g, with the possibility of extending this to 0.196 g under certain assumptions. The presence, however, of most damage associated with inadequate designs without any seismic quality and the lack of regard for any of the recommendations of the standard itself in effect denies the need.

The problem therefore lies rather in the need to adapt the local factor of each environment rather than to conduct an overall review and update of the state regulations after the occurrence of specific events. In many cases, the local effect is dominant on



the effects of the source and wave propagation, and thus, its inclusion in the estimation of the expected ground motion is of prime importance.

Quantifying the local effect is very complex because it involves many aspects. In studies at regional scale such as SISMIMUR, more or less simple geological classifications tend to be employed, encompassing different soil types in the region of study. For each class an average amplification factor is adopted, which is applied to the estimated motion in hard rock or soil, thus the resulting movement includes the local effect [2].



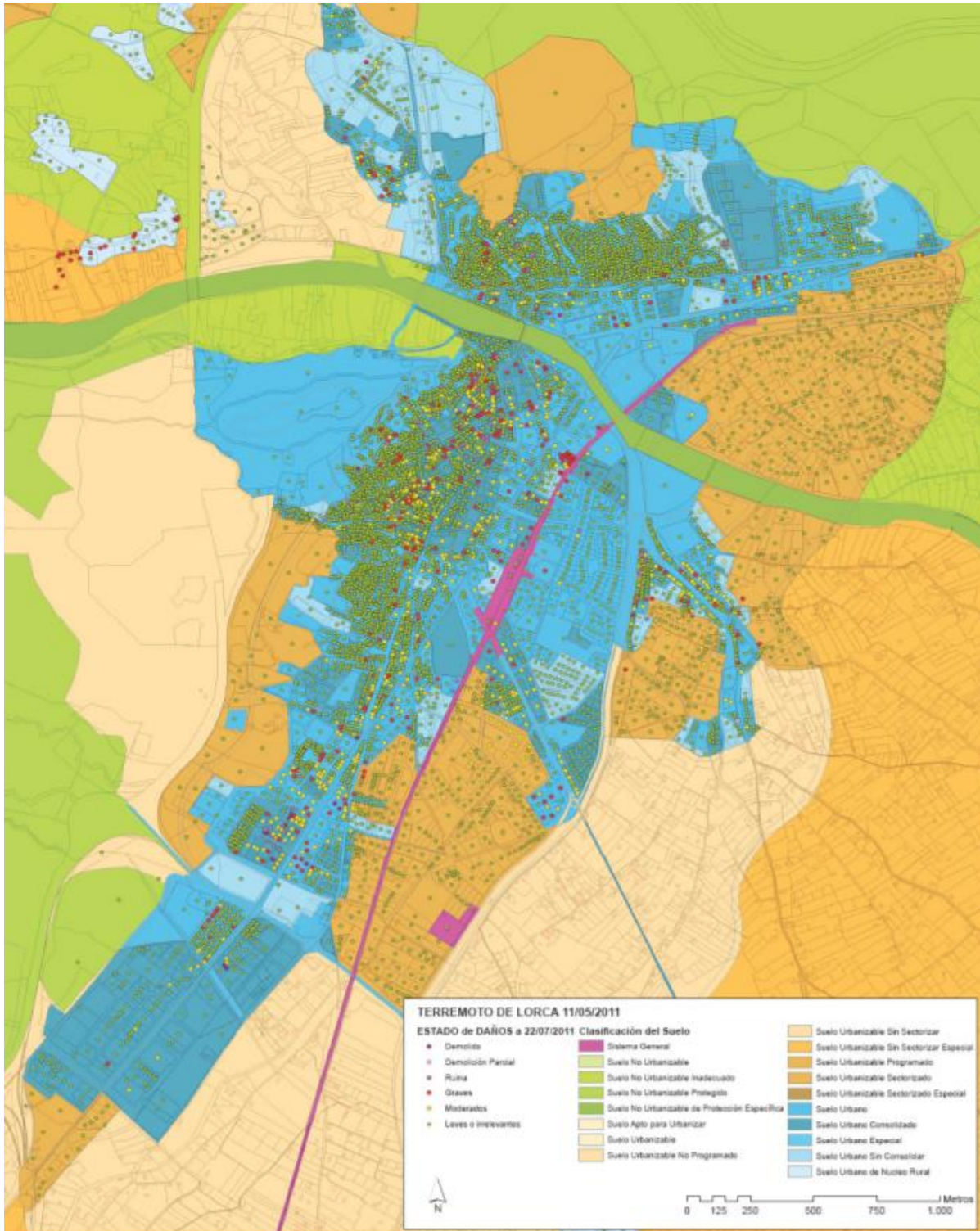

Figure 19: Distribution of damage in urban planning schedule.

In this field, it is important to consider the necessary adaptation of many buildings now to be rebuilt with CTE legislation approved in 2007. This will alter the original configuration of almost all these buildings. That presents a unique opportunity to review the entire General Plan, the principal technical tool in the Spanish legal system at municipal level.

## **4. Conclusions and future performances**





## Seismicity

Seismicity studies require that the basic information, such as seismic catalogues, to be as complete and homogeneous as possible, both in time and space and in the size parameters of earthquakes. In order to have this quality in the data, specific studies of seismicity are required. On the one hand, the historical period must be investigated, where, as we have seen in this report, the earthquakes that took place from the 15th to the 20th century marked a level of seismic activity in Lorca that must be taken into account. The diversity of archives, both at the local, provincial or state level, with possible information regarding earthquake damage, should be expunged by archival specialists who transfer the data for subsequent evaluation by seismologists. Likewise, the instrumental part of the seismic catalogue requires a review of recorded earthquakes since the beginning of the 20th century using methodologies appropriate to current knowledge.

The hypocentral determination of earthquakes is based on the propagation times of the different phases that make up the seismic waves, these being obtained by theoretical calculations from a certain structure of the crust. Therefore, in order to minimize the uncertainties in the determinations of the epicentral coordinates and the depth of the seismic foci, it is considered necessary to continue carrying out the projects that are involved for the knowledge of the cortical structure.

The successive improvement that was made in the instrumentation in the region of Murcia due to the earthquakes of 1999, 2002 and 2005 has allowed the recent earthquake in Lorca to have had a very good quality and quantity of data, so it should continue with the improvement of instrumentation in other parts of Spain where seismicity also has an important level of activity.

Taking into the consideration all the presented information, the preliminary conclusions are the following:

- *Alhama de Murcia* Fault is the fault with greater evidence of Quaternary activity in the area, with evidence of paleoseismic activity ( $M > 6.0$ ) over the last 1000 years, associated with thermal springs and a well-recognized surface trace. There was destructive historical seismicity located along the trace during the XVII, XVIII and XIX centuries. FAM has a clear geomorphological expression in this area and whose trace is parallel to one of the nodal planes of focal mechanisms obtained for the earthquakes of May 11, 2011. The sinistral strike-slip movement of the fault is consistent with the focal mechanism solution.
- The high seismic intensity experienced by the town of Lorca (intensity VII EMS-98 scale, data IGN) associated with a magnitude 5.1  $M_w$ , may be due to the earthquake spread from the *Sierra de la Tercia* (epicentral area) to the SW. The lack of geological effects towards the east of the epicentre supports this possible directionality of propagation.

- The wave propagation supports the directionality of the FAM rupture spread from the epicentral area, crossing the city of Lorca. This reason associated with the shallowness of the earthquake, would explain the high seismic intensity and peak accelerations of 0.36 g (IGN data) recorded in the accelerometer of the old prison of Lorca (located in the downtown).
- The increasing in static stress (Coulomb Stress-Transfer Model) on the segments of the *Alhama de Murcia* Fault generated by the main earthquake may have increased the likelihood of earthquake occurrence in these areas. However, it is not possible specify temporary occurrence of these earthquakes.
- The orientation of the principal axe of the strain ellipsoid (ey), obtained from the archaeoseismological study is NW-SE, is consistent with the regional tectonic stress field and focal mechanism of the main earthquake and also with the epicentral location.
- The Archaeoseismological data (more than a hundred values) suggest an origin of the deformation associated with a nearby seismic field, implying that most of the main earthquake rupture occurred beneath the historic city of Lorca because the faulting subsurface rupturing runs below the Lorca village.
- With these data and their inclusion in the Environmental Seismic Intensity Scale ESI07, this preliminary geological report will improve the information of historical earthquakes and epicentral location, improving the knowledge of the seismic process in Spain.

The experience provided by the Lorca earthquake of May 11, 2011 brings us the following steps:

1. It is necessary to implement a planning and seismic strategy with fast action protocols. These protocols should incorporate damage assessment forms, which are rigorous yet simple and adaptable to a massive intervention by technicians and volunteers. According to that, the Spanish government has adopted a new law, "*Ley 7/2012, de 20 de julio, reguladora de la reedificación por sustitución forzosa para la urgente reconstrucción de Lorca*", which is attached to this document and may be consulted in details.
2. It is very important to integrate the local seismic factor. It is not necessary to cause general changes in seismic regulations based on specific events, but to update tools that empower at regional and local level to prevent seismic vulnerabilities in the various municipalities.
3. The large number of buildings that will require having their configuration modified during the rebuilding because of the need to adapt to current building regulations recommends a complete overhaul of the General Municipal Plan in Lorca. Technifying urban planning, adapting building typologies to particular seismic problems based on tools such as microzoning or SISMIMUR in cities with high risk of major seismic events or vulnerabilities like Lorca, is recommended as a future policy.

In Spain, the Region of Murcia has moderate to high seismicity. On the last 20 years have occurred events producing considerable economic losses. Recently, in May 11 of 2011, an earthquake of Mb 5.1 stroke Lorca. At December 29th of 2011, the estimated





losses, only in insured buildings, were around 332.5 million of Euros. In order to design risk management strategies, in this work are estimated the expected losses in the Region of Murcia.

The exposed value of the buildings of the Region of Murcia was estimated from cadastral statistics. This value was geographically distributed by population entities according to the number of inhabitants. Buildings have been classified into structural typologies, based on the construction techniques of the Region and the buildings description developed on previous studies. Each structural typology was characterized with specific vulnerability curves that relate, for a given ground motion intensity, the expected value of loss and its standard deviation. The expected losses were estimated taking into account set of random events generated according to the seismicity of the country.

This analysis allows estimating the exceedance rate of losses, the probability of exceedance of a given loss in a given time frame, as well as the probability of exceedance of a given loss in the following  $t$  years. From the results, it is observed that the loss exceedance rate, for losses similar to those observed in the recent earthquake of Lorca, is near to 0.1 (loss events per year). Also, the probabilities of exceedance, in a given time frame are as follows: around 45% during the next 10 years, 80% in 25 years, and more than the 90% for  $T \geq 50$  years. Those values reflect that loss events, such as the observed in the recent earthquake of Lorca (in insured assets) are not extreme events; those losses are related to the seismicity of the region and the vulnerability of the buildings.

Regarding the seismic safety requisites of the buildings, if it is considered as a reference a return period of 500, it is observed that the probable maximum loss, for this return period, is around 16.8% of the gross regional product of Murcia, (8.7% of the exposed value) which is a significant loss. Then, it should be remarked that the safety requisites should not be defined only in terms of the frequency of the hazardous events, but in terms of the expected losses.

In this work are compared the losses observed (in insured buildings) during the earthquake of Lorca and the losses estimated for all possible seismic scenarios in the Region of Murcia. For risk management, it must be remarked that observed and calculated risks are two quite different things. Therefore, the design of risk reduction programs, as well as risk financing alternatives, should be supported on probabilistic risk estimates, taking into account aspects related to risk perception, judgments of experts and groups of representatives from various interested parties, in order to build trust and consensus.

## References

- [1] Tomás, A. & Díaz, E., Proposal of a form for post-earthquake rapid evaluation of buildings. Internal report, Department of Civil Engineering, Technical University of Cartagena (UPCT): Cartagena, Spain, 2013.
- [2] General Directorate of Civil Protection, Civil protection special plan to the seismic risk in the Region of Murcia (SISMIMUR). Department of the Presidency of the Region of Murcia: Murcia, Spain, 2006.
- [3] Department of Public Works and Planning of the Region of Murcia, Guidelines for the definition of an antiseismic strategy. FHECOR Knowledge: Murcia, Spain, 2012.
- [4] Martínez Guevara, J. B. 1985. Sismicidad histórica de la Región de Murcia. IX Coloquio de Geógrafos Españoles.
- [5] Martínez Solares, J. M. y Mezcuca Rodríguez, J. 2002. Catálogo sísmico de la Península Ibérica.
- [6] Rodríguez De La Torre, F. 1993. Efectos del terremoto del 1 de noviembre de 1755 en la actual Región de Murcia. Murgetana.
- [7] Khazaradze et al., 2008; Frontera et al., 2012.
- [8] Masana et al., 2004; Martínez-Díaz et al., 2012a; Ortuño et al., 2012.
- [9] Martínez-Díaz et al. 2012b.
- [10] Rodríguez-Peces et al., 2012
- [11] Bousquet, 1979; Silva, 1994; Martínez-Díaz, 2002.
- [12] Frontera et al., 2012; Martínez-Díaz et al., 2012a.
- [13] Stein, 1999; Chen et al., 2010.
- [14] Mallet, 1862; Musson, 1996; Korjenkov and Mazor, 1999; Nur and Cline, 2000; Marco et al., 2003; Ambraseys, 2006; Galadini et al., 2006; Al-Tarazi and Korjenkov, 2007; Marco, 2008; Guidoboni and Ebel, 2009; Reicherter et al., 2009; Sintubin et al., 2010; Talwani, 2014; Stiros and Blackman, 2014; Kyriakides et al., 2016.
- [15] Giner-Robles et al., 2009; Korjenkov and Mazor, 1999; Rodriguez-Pascua et al., 2011.
- [16] Nur and Burgess, 2008; Al-Tarazi and Korjenkov, 2007.
- [17] Hinzen, 2009, 2011.
- [18] Murphy 1999; Buforn et al. 2005; Gaspar-Escribano et al. 2005, 2008; Gaspar-Escribano and benito 2007.
- [19] Martínez Moreno et al., 2012.
- [20] Quagliarini et al., 2016; Ferreira, et al., 2014.
- [21] Goula et al., 2011.





# Bibliography

- S. García-ayllón. Lorca earthquake analysis: GIS diagnosis & Aftershock management.
- S. García-Ayllón. Proposal for new values of behaviour modifiers for seismic vulnerability evaluation of reinforced concrete buildings applied to Lorca (Spain) using damage data from the 2011 earthquake.
- C. A. Brebbia (2014). Risk analysis IX. Wessex Institute of Technology. UK.
- Instituto Geográfico Nacional (2011). Informe del sismo de Lorca del 11 de mayo de 2011. UCM.
- Instituto Geográfico Nacional. Estadística y cartografía sísmica.
- Instituto Geológico y Minero de España, IGME (2011). Informe geológico preliminar del terremoto de Lorca del 11 de mayo del año 2011, 5.1 Mw.
- Lorca Renace. Edificios religiosos.
- Advances in urban planning and territorial management in the city of Lorca after the earthquake of May 11, 2011.
- Monografies tècniques (2011). El terremoto de Lorca del 11 de mayo de 2011. Instituto Geológico de Cataluña. Barcelona.
- S. García-Ayllón. Proposal for new values of behaviour modifiers for seismic vulnerability evaluation of reinforced concrete buildings applied to Lorca (Spain) using damage data from the 2011 earthquake.
- Salcedo Hernández, José-Carlos & Campesino Fernández, Antonio-José (2012). Experiencias constructivas del terremoto de Lorca. Instituto Interuniversitario de Geografía. Universidad de Alicante.
- SISMIMUR. Sismicidad y Tectónica de la Región de Murcia.
- S. García-Ayllón & A. Tomás (2014). The new SISMIMUR plan: seismic urban planning in the region of Murcia (Spain) after the earthquake of May 11, 2011. Department of Civil Engineering, Technical University of Cartagena. UPCT.
- Tomás Espín, Antonio (2013). Tema 16. Diseño sismorresistente. Dpto. Ingeniería Civil. UPCT.



## **Attached documents:**

*Ley 7/2012, de 20 de julio, reguladora de la reedificación por sustitución forzosa para la urgente reconstrucción de Lorca.*







## LEGISLACIÓN CONSOLIDADA

---

Ley 7/2012, de 20 de julio, reguladora de la reedificación por sustitución forzosa para la urgente reconstrucción de Lorca.

---

Comunidad Autónoma de la Región de Murcia  
«BORM» núm. 168, de 21 de julio de 2012  
«BOE» núm. 44, de 20 de febrero de 2013  
Referencia: BOE-A-2013-1870

---

### TEXTO CONSOLIDADO

#### Última modificación: 27 de marzo de 2015

#### EL PRESIDENTE DE LA COMUNIDAD AUTÓNOMA DE LA REGIÓN DE MURCIA

Sea notorio a todos los ciudadanos de la Región de Murcia, que la Asamblea Regional ha aprobado la Ley reguladora de la reedificación por sustitución forzosa para la urgente reconstrucción de Lorca.

Por consiguiente, al amparo del artículo 30.Dos, del Estatuto de Autonomía, en nombre del Rey, promulgo y ordeno la publicación de la siguiente Ley:

#### PREÁMBULO

Como consecuencia de los seísmos acaecidos en el municipio de Lorca el día 11 de mayo de 2011 fueron numerosos los daños producidos; en particular, ha sido importante el número de viviendas destruidas, habiéndose dictado, para paliar esta situación, diversos reales decretos-leyes por el Gobierno de España, entre ellos el Real Decreto-ley 6/2011, que estableció ayudas para la reconstrucción de viviendas.

Esta medida, por sí sola, se ha revelado como insuficiente para conseguir el objetivo de la total reconstrucción de Lorca, fundamentalmente por la dificultad de aunar voluntades de los propietarios de edificios demolidos que deben proceder a su reedificación y no logran alcanzar un acuerdo unánime, y ello exige que las administraciones públicas encuentren soluciones ágiles y flexibles para lograr la reconstrucción, siempre fundadas en las sólidas razones de interés público que concurren.

Ante este nuevo problema se aprobó el Real Decreto-ley 11/2012, que, en su artículo 8, declara que las actuaciones de reconstrucción de viviendas afectadas por el terremoto podrán ser objeto de ejecución forzosa en los términos previstos en el Texto Refundido de la Ley de Suelo (en lo sucesivo TRLS), señalando en su artículo 9 que el SEPES tendrá la condición de agente edificador en los procedimientos de sustitución forzosa. Asimismo, añade que la Comunidad Autónoma ostenta la facultad de legislar sobre esta materia en el ámbito de sus competencias.

Las medidas de ejecución forzosa previstas en el TRLS son la expropiación por incumplimiento de la función social de la propiedad, la venta forzosa y la sustitución forzosa.

Sin perjuicio de poder utilizar la expropiación forzosa y la venta forzosa, ya regulados en la Ley de Expropiación Forzosa y en el TRLS, resulta necesario regular decididamente el mecanismo de la sustitución forzosa como herramienta de general aplicación para la

reconstrucción de Lorca, por considerarla más respetuosa con el derecho de propiedad que la expropiación y más ágil que la venta forzosa, por cuanto no se hace necesaria la inclusión de la parcela en el Registro de Solares ni dejar pasar el plazo de dos años desde su inclusión en dicho Registro.

Al regular la sustitución forzosa se han planteado como alternativas la del establecimiento de una regulación con carácter general de esta institución modificando el TRLS o, bien, la elaboración una ley específica para el caso de Lorca.

Finalmente se ha optado por esta segunda opción, ya que la necesidad y la urgencia con la que se pretende proceder a la reconstrucción de los inmuebles demolidos hace necesaria una regulación que determine plazos de ejecución, publicidad y tramitación de instrumentos más cortos que en supuestos normales.

En cuanto al contenido de la ley, parte de la obligación de los copropietarios de solicitar licencia de obras en el plazo de dos meses desde la entrada en vigor de la ley, siempre y cuando haya transcurrido, igualmente, el plazo de dos meses desde la concesión de la correspondiente ayuda prevista en el Real Decreto-ley 6/2011. En caso de no hacerlo se prevé un procedimiento para declarar dicho incumplimiento, cuya resolución declarará éste, incorporará un pliego de condiciones y convocará un concurso para seleccionar a un agente edificador que realizará la obra por cuenta de los propietarios.

Una vez producida dicha resolución, se podrán presentar, en el plazo de dos meses, Programas de Actuación Edificadora en el que cada uno de los licitadores presente una propuesta técnica y una proposición jurídico-económica, resultando adjudicatario aquel que presente la oferta más ventajosa según los criterios de adjudicación establecidos en el pliego de condiciones.

No obstante, y con el fin de que sean los propietarios los que lleven a cabo la reconstrucción, se prevé la posibilidad de que si, al menos, un 50% de los propietarios formula un Programa de Actuación Edificadora sean éstos los adjudicatarios de la actuación.

Y, finalmente, como mecanismo de cierre se prevé que si el concurso queda desierto se designe como agente edificador a cualquier Administración pública u organismo de ella dependiente.

Seleccionado el agente edificador se procederá a la tramitación administrativa del Programa de Actuación Edificadora, cuya aprobación conllevará la concesión de la licencia de obras correspondiente y determinará el inicio del cómputo del plazo establecido para la ejecución de la actuación.

Asimismo, se regulan pormenorizadamente las relaciones entre los propietarios y el agente edificador y las consecuencias que genera el impago de las cuotas de edificación.

## CAPÍTULO I

### Disposiciones generales

#### **Artículo 1.** *Objeto y ámbito de aplicación de la ley.*

Esta ley tiene por objeto la regulación del mecanismo de sustitución forzosa para proceder a la urgente reedificación de los inmuebles que, habiendo estado en régimen de propiedad horizontal, hayan sido demolidos o deban demolerse como consecuencia del terremoto acaecido el 11 de mayo de 2011 en el municipio de Lorca.

#### **Artículo 2.** *Deber de edificar y plazo.*

1. Los copropietarios de inmuebles descritos en el artículo 1 deberán solicitar licencia municipal de obras para su reedificación en el plazo de dos meses desde la entrada en vigor de la presente ley, si se tratara de solar, o desde la notificación de la declaración de ruina si la presente ley ya estuviera en vigor, siempre y cuando haya transcurrido, igualmente, el plazo de dos meses desde la concesión de la correspondiente ayuda para la reconstrucción de viviendas reguladas en el Real Decreto-ley 11/2012.

Los copropietarios de inmuebles que hayan sido demolidos como consecuencia de los sismos acaecidos en fecha 11 de mayo de 2011 deberán otorgar la escritura pública de declaración de obra nueva, como máximo, transcurrido un mes desde la concesión de la

licencia municipal de obras para su reedificación, siempre que hubieran sido compelido a ello por, al menos, la mitad del resto de los copropietarios.

2. El incumplimiento de los plazos anteriores habilitará al ayuntamiento para la edificación forzosa mediante el mecanismo de expropiación forzosa por urgente ocupación o tasación conjunta, por causa del incumplimiento de la función social de la propiedad o, en su caso, mediante el mecanismo de sustitución forzosa regulado en esta ley.

3. Una vez otorgada la escritura de declaración de obra nueva los propietarios están obligados al cumplimiento de las obligaciones de pago.

El incumplimiento total de esta obligación faculta al ayuntamiento para la expropiación forzosa por incumplimiento de la función social de la propiedad. El beneficiario de esta expropiación será el ayuntamiento.

## CAPÍTULO II

### Sustitución forzosa por incumplimiento

**Artículo 3.** *Declaración de incumplimiento del deber de edificar en los supuestos de sustitución forzosa.*

La sustitución forzosa necesitará como requisito previo la declaración por el Ayuntamiento de incumplimiento del deber de edificar, mediante el procedimiento regulado en esta ley, iniciado de oficio o a instancia de interesado.

**Artículo 4.** *Procedimiento de declaración de incumplimiento.*

1. Iniciado el procedimiento para la declaración de incumplimiento se solicitará del Registro de la Propiedad certificación de dominio y cargas del solar correspondiente, debiendo hacerse constar por nota marginal el comienzo del procedimiento para la declaración de incumplimiento del deber de edificar.

2. El órgano municipal competente acordará la apertura de un trámite de audiencia de diez días a las personas propietarias y demás titulares de bienes y derechos afectados.

3. Ultimado el periodo de audiencia, el Ayuntamiento deberá resolver sobre la declaración de incumplimiento del deber de edificar en el plazo máximo de un mes, siendo, en todo caso, el plazo máximo de resolución del procedimiento el de tres meses.

4. No obstante lo anterior, el procedimiento podrá terminarse, sin acuerdo de alguna otra medida, si con anterioridad a la declaración se hubiera solicitado por parte de los propietarios licencia para reedificar.

**Artículo 5.** *Efectos y contenido de la declaración de incumplimiento del deber de edificar.*

1. La declaración de incumplimiento del deber de edificar contenida en resolución que agote la vía administrativa:

a) Deberá contener la declaración de la situación de ejecución por sustitución de la persona propietaria incumplidora del deber de edificar.

b) Incorporará la aprobación del pliego de condiciones a que se refiere el artículo siguiente.

c) Acordará la convocatoria del concurso para la presentación de Programas de Actuación Edificatoria y su publicación.

d) Deberá ser comunicada, a los efectos que procedan, conforme a la legislación aplicable y mediante certificación administrativa de la resolución dictada, al Registro de la Propiedad para la práctica de nota marginal a la inscripción de la correspondiente finca.

2. Los propietarios que representen al menos el 50 % de la superficie del solar o, en su caso, el 50 % de las cuotas de participación en la división horizontal, tendrán derecho preferente para promover la edificación del mismo en las condiciones y plazo determinados por el Programa de Actuación Edificatoria que se apruebe, siempre que formulen dicho Programa dentro del plazo de dos meses a contar desde la publicación de la convocatoria del concurso.

3. En los supuestos en que el concurso quede desierto, el Ayuntamiento, por sí mismo o a través de sus propios organismos, entidades o empresas de capital íntegramente público o

adscritos a otras administraciones públicas, podrá promover directamente, o mediante convenio, la ejecución de la edificación en régimen de sustitución en condiciones y plazo determinados por el Programa de Actuación Edificatoria que se apruebe.

### CAPÍTULO III

#### Concurso

**Artículo 6.** *Contenido del pliego de condiciones.*

La convocatoria del concurso requerirá la aprobación del pliego de condiciones, conforme a la normativa de régimen local, determinando las que hayan de cumplir los Programas de Actuación Edificatoria que se presenten y las personas que pretendan resultar adjudicatarias de su ejecución, en el que habrán de contemplarse los siguientes extremos:

A) Con carácter obligatorio:

a) La identificación del solar a que se refiere y normativa urbanística que regula sus condiciones edificatorias.

b) Plazos de ejecución de la edificación.

c) Garantías provisional y definitiva que deberán ser constituidas y modo en que habrán de serlo.

d) Importe máximo de los costes de elaboración del proyecto.

e) Criterios de adjudicación del Programa de Actuación Edificatoria.

f) Documentación que deberá presentarse para la acreditación de la capacidad de obrar de la persona proponente y determinación de los requisitos que, en su caso, se exijan para acreditar la solvencia técnica, profesional, financiera y económica requeridas.

g) Lugar de presentación de los Programas de Actuación Edificatoria.

B) Con carácter potestativo:

a) Prescripciones técnicas, tipológicas y estéticas que deberán respetarse en la redacción del proyecto de edificación y, en su caso, de urbanización de las obras complementarias precisas. A tal fin expresará:

1.º Los criterios orientativos relativos al diseño arquitectónico de la construcción a realizar, incluyendo las características básicas de la distribución interior y la expresión formal de las fachadas.

2.º La calidad mínima de los materiales constructivos.

3.º Los criterios básicos de integración volumétrica de la construcción a realizar en su entorno y paisaje urbanos.

b) Usos a que deberá destinarse la edificación de entre los permitidos por el planeamiento.

c) Criterios de eficiencia energética y ecológica que deba respetar el proyecto.

**Artículo 7.** *Procedimiento de concurso.*

1. El Ayuntamiento publicará la convocatoria del concurso mediante edicto y, además de medios electrónicos, en el Boletín Oficial de la Región de Murcia, notificándolo a los propietarios afectados.

2. El plazo para la presentación de Programas de Actuación Edificatoria será de dos meses desde el día siguiente de la publicación del anuncio.

3. Concluido el plazo para la presentación de programas, el órgano competente municipal ordenará la apertura de las proposiciones en el plazo de veinte días.

4. El Ayuntamiento, en plazo máximo de dos meses desde la apertura de las proposiciones, deberá adjudicar el Programa de Actuación Edificatoria al concursante que hubiera presentado la oferta más ventajosa según los criterios de adjudicación señalados en el pliego.

5. La adjudicación de un Programa de Actuación Edificatoria a un licitador conlleva su designación como agente edificador.

6. Adjudicado el programa se procederá a su tramitación conforme a lo previsto en el artículo 10.

#### CAPÍTULO IV

#### Programas de Actuación Edificatoria

**Artículo 8.** *Definición, objeto y función de los Programas de Actuación Edificatoria.*

1. Los Programas de Actuación Edificatoria determinan y organizan la actividad de edificación de solares en el caso de que se haya declarado la situación de sustitución de la ejecución por incumplimiento del deber de edificar de sus propietarios, estableciendo las condiciones para su efectivo desarrollo e identificando al agente edificador sustituto del propietario incumplidor.

2. Deberán satisfacer, al menos, los siguientes objetivos básicos:

a) La ejecución de las obras de edificación precisas para la materialización del aprovechamiento previsto por el planeamiento y el cumplimiento de los deberes legales de la propiedad, incluso el pago de las tasas e impuestos que graven la construcción, en todo caso.

b) La ejecución de las obras de urbanización complementarias.

3. El coste de las inversiones necesarias para cumplir estos objetivos deberá afrontarse por la propiedad del solar, en el modo que se establezca en la aprobación del programa.

4. Los Programas de Actuación Edificatoria:

a) Definirán la edificación a nivel de proyecto básico y, en su caso, las obras complementarias de urbanización.

b) Preverán el inicio, la terminación y el calendario de la ejecución de las obras.

c) En aquellos casos en que la ejecución de la edificación no sea promovida directamente por el Ayuntamiento, por sí mismo o a través de sus propios organismos, entidades o empresas de capital íntegramente público o adscritos a otras administraciones públicas, asegurarán el cumplimiento de sus previsiones mediante garantía financiera al primer requerimiento, prestada y mantenida por la persona adjudicataria seleccionada como agente edificador, en cualquiera de las formas permitidas por la legislación de régimen local. El importe de la garantía provisional será del siete por ciento del coste de ejecución material, excluido el Impuesto sobre el Valor Añadido o tributo que pudiera sustituirle, de las obras de edificación y urbanización complementarias; mientras que la definitiva será del diez por ciento de la referida cantidad.

**Artículo 9.** *Contenido de los Programas de Actuación Edificatoria.*

Los Programas de Actuación Edificatoria estarán integrados por los siguientes documentos:

1. Una propuesta técnica con el siguiente contenido:

a) Proyecto básico de edificación acompañado, en su caso, de proyecto o anteproyecto de urbanización.

Ambos documentos contendrán una memoria de calidades, describiendo como mínimo los elementos más significativos y relevantes que permitan estimar el coste total de la actuación, cuyo presupuesto se incluirá en la proposición jurídico-económica.

2. Proposición jurídico-económica, que deberá precisar los siguientes aspectos:

a) Desarrollo de las relaciones entre el agente edificador y la propiedad de la finca, expresando, en su caso, los eventuales acuerdos ya alcanzados y las disposiciones relativas al modo de financiación de la actuación y retribución del agente edificador.

b) Determinación de la totalidad de los costes de ejecución de la actuación edificatoria, en los que se comprenderán los de edificación; los de ejecución de la urbanización complementaria, en su caso; los honorarios de los profesionales que deban intervenir y de las empresas de control de calidad, los de formalización de los seguros legalmente exigibles y los gastos financieros; las indemnizaciones por extinción de derechos incompatibles, en su

caso; las tasas e impuestos que graven la concesión de la licencia y la construcción; y los gastos generales y el beneficio empresarial que el agente edificador proponga por la actividad de promoción de la actuación edificatoria.

c) Determinación de las causas tasadas y excepcionales que podrán motivar la variación de los costes de la actuación edificatoria.

d) Cuando en la edificación se prevean usos heterogéneos o el valor de sus diversas partes, por razón de su localización en planta o en altura, orientación u otros análogos, resulte muy diferente, se aplicarán coeficientes correctores de uso y localización, justificándolos en función de sus valores relativos de repercusión, con la finalidad de homogeneizar cada uno de los metros cuadrados edificables lucrativos de la construcción de que se trate.

e) Propuesta de división horizontal en la que se identificarán las partes que le correspondan a la persona propietaria original y, en su caso, al agente edificador. Esta propuesta deberá contener cuotas de participación en los gastos de la actuación.

**Artículo 10. Procedimiento para la aprobación de los Programas de Actuación Edificatoria.**

1. Una vez adjudicado el Programa de Actuación Edificatoria se procederá a su tramitación administrativa.

2. El Programa de Actuación se aprobará inicialmente por el Ayuntamiento, que lo someterá a información pública de veinte días de duración como mínimo; se notificará a los propietarios y titulares que consten en el Registro de la Propiedad, en el expediente de declaración de incumplimiento del deber de edificar, como personas titulares de derechos afectados por la actuación edificatoria propuesta y a las demás personas interesadas personadas en el mismo, y se anunciará en el Boletín Oficial de la Región de Murcia. En el anuncio se identificará la parcela o solar a que se refiere, se dará publicidad de las condiciones que se impongan y se advertirá de la posibilidad de formular alegaciones.

3. Concluida la información pública, corresponderá al Ayuntamiento acordar la aprobación definitiva, señalando los cambios respecto de lo aprobado inicialmente, lo que se notificará a los propietarios y a los titulares afectados y a quienes hubieran presentado alegaciones, y se publicará en el Boletín Oficial de la Región Murcia.

En el supuesto de que el Programa de Actuación Edificatoria contenga modificaciones, éstas serán obligatorias para el adjudicatario del programa siempre que no impliquen una variación superior al 10% de los costes de actuación edificatoria.

4. La aprobación de un Programa de Actuación Edificatoria conllevará la concesión de la correspondiente licencia de obras, así como la designación del agente edificador, responsable de ejecutar la actuación edificatoria en las condiciones establecidas en el programa.

Asimismo, se fijarán los plazos para presentar, en su caso, los documentos técnicos que pudiesen resultar necesarios, así como los documentos de proyecto de ejecución de la edificación y obras complementarias de urbanización y, en su caso, proyecto de reparcelación.

5. El cómputo del plazo establecido para la ejecución de la actuación edificatoria empezará a contar desde la fecha en que sea definitivo en vía administrativa el acuerdo de aprobación definitiva del Programa de Actuación Edificatoria.

6. Resuelta la aprobación definitiva, el Ayuntamiento la notificará a los propietarios y expedirá certificación de la misma para su inscripción en el Registro de la Propiedad, que contendrá las condiciones y plazos de edificación recogidos en el programa.

**Artículo 11. Relaciones entre el agente edificador y las personas propietarias.**

El Programa de Actuación Edificatoria deberá regular las relaciones entre el agente edificador y las personas propietarias afectadas, conforme en todo caso a las siguientes reglas:

a) El Programa de Actuación Edificatoria deberá determinar el modo o modos en que deberá retribuirse la labor edificatoria.

b) El agente edificador deberá soportar la totalidad de los gastos derivados de la edificación.



c) Las personas propietarias deberán satisfacer la labor edificatoria retribuyendo al agente edificador la totalidad de los costes derivados de la ejecución de dicha actuación.

**Artículo 12. *Facultades del agente edificador.***

Corresponden al agente edificador las siguientes facultades:

a) Someter a tramitación y aprobación administrativa cuantos instrumentos sean precisos para la ejecución de la actuación edificatoria, así como ser oído antes de la aprobación de dichos instrumentos.

b) Exigir los pagos en metálico cuando procedan.

c) Ocupar, previa autorización, los terrenos para la realización de estudios geotécnicos, arqueológicos o cualesquiera otros, así como de los necesarios para desarrollar las infraestructuras de urbanización complementaria.

**Artículo 13. *Proyecto de reparcelación.***

En los supuestos en los que sea necesario, el proyecto de reparcelación se redactará y tramitará con aplicación de las técnicas y procedimiento de la reparcelación, conforme a lo previsto en el Decreto Legislativo 1/2005, de 10 de junio, por el que se aprueba el Texto Refundido de la Ley del Suelo de la Región de Murcia, con las siguientes peculiaridades:

a) Podrán constituir fincas resultantes los diferentes pisos o locales que conformen el edificio que se construya de acuerdo con el proyecto de ejecución aprobado.

b) Contendrá la valoración de las fincas resultantes y las compensaciones económicas que procedan, asignando cuotas de participación y la distribución correspondiente de los costes de la actuación. El proyecto de reparcelación realizará tales operaciones en la forma dispuesta por la normativa hipotecaria aplicable a efectos de su acceso al Registro de la Propiedad.

**Artículo 14. *Pago en metálico de los costes de la actuación edificatoria.***

1. El pago en metálico de los costes de edificación se adecuará a las reglas siguientes:

a) El importe de las cuotas y la forma de su liquidación serán aprobados por el Ayuntamiento, sobre la base de una memoria y una cuenta detallada y justificada y previa audiencia de las personas interesadas. El importe deberá corresponderse con la retribución fijada para el agente edificador en el acuerdo de aprobación definitiva del programa o, en su caso, con la modificación aprobada por la Administración actuante.

b) Las cuotas de edificación se requerirán con la periodicidad que establezca el Programa de Actuación Edificatoria.

El requerimiento de pago que practique el agente edificador a las personas propietarias concederá a éstos un plazo de un mes para efectuarlo.

c) Podrá reclamarse el pago anticipado de las inversiones previstas, cuando la ejecución de la actividad edificatoria, en régimen de ejecución directa por parte del Ayuntamiento, por sí mismo o a través de sus propios organismos, entidades o empresas de capital íntegramente público o adscritos a otras administraciones públicas, sea consecuencia de incumplimiento del deber de edificar en el plazo impuesto a raíz de la percepción de ayudas destinadas a la reconstrucción de viviendas destruidas o demolidas.

d) Todas las cuotas que se reclamen se entenderán practicadas con carácter provisional a reserva de la liquidación definitiva. La retribución fijada en el programa será el importe a que ascienda la liquidación definitiva si no se ha producido su revisión.

e) El impago de las cuotas dará lugar a la ejecución sin más trámites de la garantía prestada, sin perjuicio de que el agente edificador pueda promover su recaudación mediante apremio sobre la persona titular de la finca correspondiente por la Administración actuante y en el procedimiento civil que corresponda.

2. La demora en el pago devengará el interés legal del dinero en favor del agente edificador. Incurrirá en mora la cuota impagada al mes de la notificación de la resolución que autorice su cobro inmediato.

Acreditado por el agente edificador haber realizado el requerimiento de pago en legal forma, el Ayuntamiento ejecutará el aval prestado. En el supuesto de que se hubiese

agotado la garantía prestada, dictará providencia de apremio sin conceder nuevos plazos para el pago y no suspenderá el procedimiento sino en los casos excepcionales previstos en la legislación aplicable, previa prestación de garantía financiera a primera demanda en cuantía suficiente para responder de la totalidad de las responsabilidades reclamadas. Es obligación del Ayuntamiento llevar a término la vía de apremio.

3. Cada persona propietaria deberá abonar las cuotas que correspondan a las fincas que les hayan sido adjudicadas. El importe de las cuotas devengadas por cada finca se determinará repartiendo entre todas las resultantes de la actuación las cargas totales del programa, en directa proporción a su superficie edificada y sin perjuicio de las compensaciones que correspondan a los titulares por sus derechos iniciales.

**Artículo 15.** *Retasación de costes del Programa de Actuación Edificatoria.*

1. Sólo se podrá modificar la previsión inicial de gastos estimada en el Programa de Actuación Edificatoria aprobado por razón de causas excepcionales y objetivas que lo justifiquen, previamente establecidas en el propio programa.

2. La retasación de cargas, que deberá aprobarse por el Ayuntamiento, previa audiencia de las personas interesadas por plazo de veinte días, podrá suponer la modificación de las adjudicaciones de las partes de edificación establecidas en la propuesta de división horizontal o, en su caso, en el proyecto de reparcelación.

3. La modificación del proyecto de reparcelación, en su caso, se llevará a efecto por el mismo procedimiento previsto para su aprobación.

Durante su tramitación quedará suspendido el plazo de ejecución del Programa de Actuación Edificatoria.

**Artículo 16.** *Culminación del proceso de ejecución de la actuación edificatoria.*

1. Terminada la edificación de acuerdo con el proyecto de ejecución aprobado y las condiciones establecidas en el programa, el agente edificador lo pondrá en conocimiento del Ayuntamiento, aportando el certificado final de obra suscrito por la dirección facultativa de las obras.

2. El Ayuntamiento, en el plazo de quince días a contar desde dicha comunicación, procederá a realizar la inspección técnica de la misma. En caso de observar alguna deficiencia, la pondrá en conocimiento del agente edificador para que proceda a su subsanación.

3. Una vez informada favorablemente su conclusión, procederá la recepción de las obras de urbanización si éstas forman parte del Programa de Actuación Edificatoria, y con respecto a la edificación, procederá otorgar la licencia de ocupación y la inscripción en el Registro de la Propiedad de la finalización de la construcción mediante certificación administrativa que surtirá los mismos efectos que una escritura de obra nueva terminada.

4. El agente edificador estará legitimado para el otorgamiento por sí solo, en representación de todas las personas propietarias de los inmuebles resultantes y de los terceros hipotecarios, de la escritura de división horizontal y aprobación de los estatutos que hayan de regir la comunidad de propietarios, conforme a la propuesta de división horizontal o, en su caso, al proyecto de reparcelación.

**Disposición adicional única.**

La presente ley será de aplicación en aquellos supuestos en los que sea necesaria la reconstrucción de edificios en régimen de propiedad horizontal, como consecuencia de siniestros sísmicos y catastróficos.

**Disposición final única.** *Entrada en vigor.*

Esta ley entrará en vigor al día siguiente de su íntegra publicación en el Boletín Oficial de la Región de Murcia.

Por tanto, ordeno a todos los ciudadanos a los que sea de aplicación esta Ley, que la cumplan y a los Tribunales y Autoridades que corresponda que la hagan cumplir.

Este texto consolidado no tiene valor jurídico.  
Más información en [info@boe.es](mailto:info@boe.es)