



industriales  
etsii

Escuela Técnica  
Superior  
de Ingeniería  
Industrial

# UNIVERSIDAD POLITÉCNICA DE CARTAGENA

Escuela Técnica Superior de Ingeniería Industrial

## Diseño de una red de comunicaciones basada en el bus CAN para el vehículo Peugeot 106.

**TRABAJO FIN DE GRADO**

GRADO EN INGENIERIA EN TECNOLOGIAS INDUSTRIALES

**Autor:** Alejandro Torres Piernas  
**Director:** Ginés Doménech Asensi

Cartagena, Junio de 2015



Universidad  
Politécnica  
de Cartagena



# ÍNDICE

---

<b>MEMORIA DESCRIPTIVA</b> .....	7
1. Introducción y objetivos del proyecto .....	8
2. Sistema de bus CAN .....	9
2.1 Historia .....	9
2.2 Características.....	9
2.3 Capas del Bus CAN.....	11
2.4 Formato de trama .....	12
2.5 Errores.....	14
3. Descripción del vehículo .....	16
4. Sistemas a implementar en el vehículo.....	20
4.1 Sistemas pertenecientes al bus infotenimiento .....	20
4.1.1 Sistemas que posee el vehículo de serie.....	20
4.1.2 Sistemas nuevos a implementar o mejorar .....	20
4.2 Sistemas pertenecientes al bus confort .....	21
4.2.1 Sistemas que posee el vehículo de serie.....	21
4.2.2 Sistemas nuevos a implementar o mejorar .....	22
4.3 Sistemas pertenecientes al bus de tracción.....	22
4.3.1 Sistemas que posee el vehículo de serie.....	22
4.3.2 Sistemas nuevos a implementar o mejorar .....	23
4.4 Sistemas pertenecientes al bus del panel de mando del volante .....	24
5. Arquitectura del sistema .....	26
5.1 Descripción.....	26
5.2 Arquitectura del bus infotenimiento.....	27
5.3 Arquitectura del bus confort .....	29
5.4 Arquitectura del bus tracción .....	32
5.5 Arquitectura del bus panel mando volante .....	35
6. Centralitas, sensores, mandos/Interruptores y actuadores a implementar en el vehículo. ....	37
6.1 Centralitas y unidades de control.....	40
6.2 Sensores mandos/Interruptores y actuadores.....	42
7. Situación de los distintos buses y sistemas en el vehículo.....	51
7.1 Bus infotenimiento .....	51
7.1.1 Esquema general de las centralitas .....	51
7.1.2 Esquema Bus Radio / GPS.....	52
7.1.3 Esquema Bus asistencia aparcamiento .....	53
7.1.4 Esquema Bus cambio carril .....	53
7.2 Bus confort .....	54
7.2.1 Esquema general de las centralitas .....	54

7.2.2	Esquema Bus puerta conductor.....	54
7.2.3	Esquema Bus puerta pasajero.....	55
7.2.4	Esquema Bus control climatización .....	56
7.2.5	Esquema Bus columna dirección.....	56
7.2.6	Esquema Bus centralita confort .....	57
7.3	Bus tracción.....	58
7.3.1	Esquema general de las centralitas .....	58
7.3.2	Esquema Bus Airbags .....	59
7.3.3	Esquema Bus control motor (ECU).....	59
7.3.4	Esquema Bus servodirección .....	60
7.3.5	Esquema Bus ABS .....	61
7.4	Bus panel mando volante .....	61
8.	Algoritmo de comunicaciones .....	64
8.1	Comunicaciones en el bus de infotenimiento .....	65
8.2	Comunicaciones en el bus de confort .....	69
8.3	Comunicaciones en el bus de tracción.....	82
8.4	Comunicaciones en el bus del panel de mando.....	100
9.	Sistema de autodiagnosisis.....	108
10.	Presupuesto del proyecto .....	110
11.	Bibliografía.....	114
<b>ANEXO I</b>	.....	<b>116</b>

## ÍNDICE DE TABLAS

---

<b>Tabla 1:</b> Ficha técnica Peugeot 106 Fase II.....	17
<b>Tabla 2:</b> Sistemas que el vehículo posee de serie.....	19
<b>Tabla 3:</b> Arquitectura Bus de Infoteniimiento.....	28
<b>Tabla 4:</b> Arquitectura Bus de Confort.....	30
<b>Tabla 5:</b> Arquitectura Bus de Tracción.....	33
<b>Tabla 6:</b> Arquitectura Bus Panel de mando .....	36
<b>Tabla 7:</b> Otros elementos del sistema .....	38
<b>Tabla 8:</b> Descripción PINs salida Controlador MCP2515-I/SO.....	39
<b>Tabla 9:</b> Descripción PINs salida Transceptor MCP2551-I/SN .....	40
<b>Tabla 10:</b> Centralitas del sistema .....	41
<b>Tabla 11:</b> Dispositivos del sistema.....	42
<b>Tabla 12:</b> Formato mensajes SAE J1939 .....	64
<b>Tabla 13:</b> Presupuesto general del proyecto .....	110

# ÍNDICE DE FIGURAS

---

<b>Figura 1:</b> Nivel señales CAN_H y CAN_L con interferencia .....	10
<b>Figura 2:</b> Diferencia de señal entre ambas líneas .....	10
<b>Figura 3:</b> Capas del modelo OSI .....	11
<b>Figura 4:</b> Composición trama de datos.....	13
<b>Figura 5:</b> Peugeot 106 fase II.....	16
<b>Figura 6:</b> Medidas generales Peugeot 106 fase II .....	16
<b>Figura 7:</b> Motor de inyección del tipo Mono-Jetronic .....	23
<b>Figura 8:</b> Esquema general del sistema .....	26
<b>Figura 9:</b> Esquema del bus infotenimiento .....	27
<b>Figura 10:</b> Esquema del Bus confort .....	29
<b>Figura 11:</b> Esquema del bus de tracción .....	32
<b>Figura 12:</b> Esquema del Bus panel de mando del volante.....	35
<b>Figura 13:</b> Estructura unidad control señales .....	37
<b>Figura 14:</b> Diagrama bloques controlador MCP2515-I/SO .....	38
<b>Figura 15:</b> Diagrama bloques transceptor MCP2551-I/SN.....	40
<b>Figura 16:</b> Esquema bus infotenimiento .....	51
<b>Figura 17:</b> Esquema bus Radio/GPS 1 .....	52
<b>Figura 18:</b> Esquema bus Radio/GPS 2 .....	52
<b>Figura 19:</b> Esquema bus asistencia aparcamiento .....	53
<b>Figura 20:</b> Esquema bus cambio carril .....	53
<b>Figura 21:</b> Esquema bus puerta conductor.....	54
<b>Figura 22:</b> Esquema bus puerta conductor.....	54
<b>Figura 23:</b> Esquema bus puerta pasajero.....	55
<b>Figura 24:</b> Esquema bus infotenimiento .....	56
<b>Figura 25:</b> Esquema bus columna dirección 1.....	56
<b>Figura 26:</b> Esquema bus columna dirección 2.....	57
<b>Figura 27:</b> Esquema bus confort 1 .....	57
<b>Figura 28:</b> Esquema bus confort 2 .....	58
<b>Figura 29:</b> Esquema bus tracción.....	58
<b>Figura 30:</b> Esquema bus airbags .....	59
<b>Figura 31:</b> Esquema bus ECU.....	59
<b>Figura 32:</b> Esquema bus servodirección .....	60
<b>Figura 33:</b> Esquema bus ABS .....	61
<b>Figura 34:</b> Esquema bus panel mando 1 .....	61

<b>Figura 35:</b> Esquema bus panel mando 2.....	62
<b>Figura 36:</b> Esquema bus panel mando 3.....	63
<b>Figura 37:</b> Esquema bus panel mando 4.....	63
<b>Figura 38:</b> Terminales del conector OBD II .....	108

# MEMORIA DESCRIPTIVA



# 1. Introducción y objetivos del proyecto

Uno de los apartados más importantes hoy en día en los automóviles es todo su entramado de comunicaciones, ya que gracias a ellas se puede controlar desde algo tan importante como la inyección de combustible en el motor, hasta simplemente abrir o cerrar una ventanilla. También mejoran la seguridad de los pasajeros con los diferentes sistemas pasivos y activos y por supuesto hacen que la experiencia de conducción sea cada vez más confortable, eficiente y segura. Cada vez son más estos sistemas y por lo tanto el medio de comunicaciones entre ellos también ha evolucionado.

Actualmente, todos los automóviles fabricados poseen un sistema de comunicaciones con una topología de varios buses. Por ello el objetivo de este proyecto es realizar una evolución alternativa de un automóvil con un sistema de comunicaciones antiguo y adaptarlo a las normas y características que ahora son usadas en la creación de cualquier automóvil. Esta evolución en el sistema de comunicaciones del vehículo se hará basándose en el Bus más utilizado actualmente en el mercado europeo como es el Bus CAN (del inglés *Controller Area Network*), este sistema de comunicaciones está regulado por el estándar internacional ISO (del inglés *International Organization of Standardization*) 11898-1 y los protocolos SAE (del inglés *Society of Automotive Engineers*) J2284 y SAE J2411 para el caso de turismos y el protocolo SAE J1939 para vehículos pesados y maquinaria agrícola. Lo que se pretende en este proyecto, es una evolución natural de este vehículo a la época actual, no solo se va reemplazar su sistema de comunicaciones si no que se van a añadir nuevos sistemas al vehículo, algunos de ellos porque es necesario implementarlos en todos los automóviles de nueva creación en la unión europea o el mundo por norma, como por ejemplo, el sistema ABS y otros por simple adecuación al mercado actual.

Para llevar a cabo este proyecto se ha hecho en primero lugar un estudio del vehículo, así como el funcionamiento del propio bus y de todos los sistemas que van a ser incluidos en este para poder conocer los diferentes sensores, actuadores, interruptores y centralitas que van a ser necesarias añadir. También se ha creado una arquitectura de todo el sistema, desde sus buses principales hasta la unión de todos los sensores mandos y actuadores con sus respectivas centralitas. Por último, se han colocado de forma aproximada en la estructura del propio vehículo.

Otra parte muy importante de este trabajo ha sido recoger todas las diferentes señales que todos y cada uno de los sistemas existentes en la evolución del vehículo necesitan para comunicar las centralitas con sus diferentes sensores y actuadores, así como para informar de alguna avería en el vehículo o el propio sistema de comunicaciones. La forma de estas señales está estandarizada en los protocolos SAE, así como el sistema de autodiagnos OBD (del inglés *On Board Diagnostics*) que será descrito posteriormente. Estos protocolos también dejan lugar a un espacio en sus protocolos para que cada fabricante particular pueda incluir más señales si le son necesarias. Es por ello que se han añadido algunas de estas señales de la forma que se ha creído más eficiente para aquellos sistemas que no estaban incluidos en estos protocolos o que simplemente no se adecuaban a las necesidades requeridas en este trabajo.

Por último, se ha establecido el presupuesto más económico posible, ya que el perfil del automóvil de estudio es el de un turismo de pequeñas dimensiones, de poca potencia y por lo tanto de precio medio/bajo. Para poder realizarlo se han consultado precios diversos de proveedores de recambios y piezas de automóviles de un perfil más bien intermedio, ya que no se ha tenido la posibilidad de contactar con los propios fabricantes de estos sensores y actuadores al ser empresas muy grandes que solo venden al por mayor.

## 2. Sistema de bus CAN

### 2.1 Historia

Los sistemas antiguos de comunicaciones en el automóvil implicaba la utilización de una enorme cantidad de cableado, ya que se basaban en el sistema de comunicaciones punto a punto, debido a la incorporación con el tiempo de cada vez más sistemas electrónicos que necesitaban ser comunicados con las centralitas, este cableado no paraba de aumentar y por lo tanto también su complejidad. Se pensó, entonces, que la industria del automóvil necesitaba de un sistema de bus que fuera robusto, fiable, con inmunidad a los ruidos internos y que transmitiera a altas velocidades en entornos difíciles como el de un automóvil (altas temperaturas, vibraciones, interferencias...).

Como solución a este planteamiento, en 1982, la empresa alemana *Robert Bosch GmbH* desarrolló un protocolo de comunicaciones basado en una topología de bus para poder transmitir los mensajes, implementándolo por primera vez en 1992 en el automóvil Mercedes Clase E. A partir del año 2008 este sistema de comunicaciones es obligatorio para todos los vehículos. Este nuevo sistema ofrece numerosas ventajas con respecto a los antiguos, como pueden ser:

- Reducción del cableado y sensores redundantes.
- Mantenimiento más fácil, debido al menor cableado y la mayor flexibilidad del mazo de cables.
- Abaratamiento de los sistemas electrónicos.
- Mayor velocidad en el intercambio de información, (Hasta 50 veces más que los usados antiguamente).

### 2.2 Características.

El sistema de bus CAN está definido por la organización internacional para la estandarización, mediante el estándar ISO-11898 y tiene las siguientes características principales:

- Protocolo en serie del tipo CSMA/CD (del inglés *Carrier Sense Multiple Access with Collision Detection*). Este protocolo define que los distintos dispositivos deben escuchar al medio antes de poder retransmitir su mensaje para determinar si el canal y sus recursos se encuentran disponibles para la retransmisión.
- El bus es un medio compartido (multiplexado), es decir, por el mismo medio de transmisión se pueden transmitir varios canales de información.
- Se trata de un protocolo "Multidifusión", es decir, todos los dispositivos pueden enviar mensajes (de uno en uno) y recibirlos. Los propios dispositivos son los encargados de al recibir la información determinar si le es o no útil. En el caso de serle útil lo almacena en su memoria y lo procesara a continuación, si por el contrario no es un mensaje destinado a este dispositivo simplemente lo rechaza en la etapa de selección del dispositivo.
- Acceso Múltiple por detección de Portadora "CSMA": El objetivo de este sistema es el de evitar que pueda haber colisiones en el bus, es decir que dos dispositivos puedan emitir un mensaje al mismo tiempo, para ello el dispositivo debe escuchar el medio para saber si en ese momento se está emitiendo otro mensaje. También establece un protocolo para el supuesto de que dos dispositivos envíen un mensaje de forma simultánea.
- Detección de colisión "CD": si 2 dispositivos de la red comienzan a transmitir un mensaje de forma simultánea, ambos detectan la colisión. Un protocolo de arbitraje basado en prioridades resuelve el conflicto.

- El medio físico que se utiliza son dos cables en forma de par trenzado, ya que así se consigue una alta inmunidad contra las interferencias electromagnéticas. También puede apantallarse. Los dos cables se denominan CAN High y CAN Low. Estos facilitan una transmisión simétrica de los datos, el que los bits son transferidos por ambas líneas usando voltajes diferentes. Esto reduce sensiblemente las distintas interferencias, ya que la interferencia afecta a ambas líneas (Figura 1) y pueden ser filtradas mediante la creación de la diferencia entra ambas señales (Figura 2). El cable simple es una manera más económica con respecto al par trenzado. Sin embargo, en este caso debe haber una conexión a tierra común que asuma la función ser segundo cable del bus.

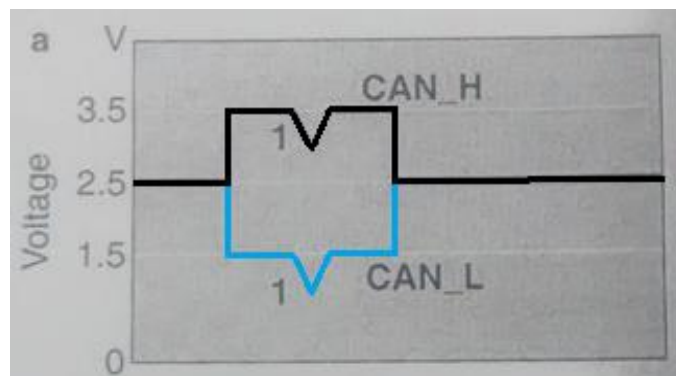

**Figura 1:** Nivel señales CAN\_H y CAN\_L con interferencia

Fuente: Bosch Automotive Handbook

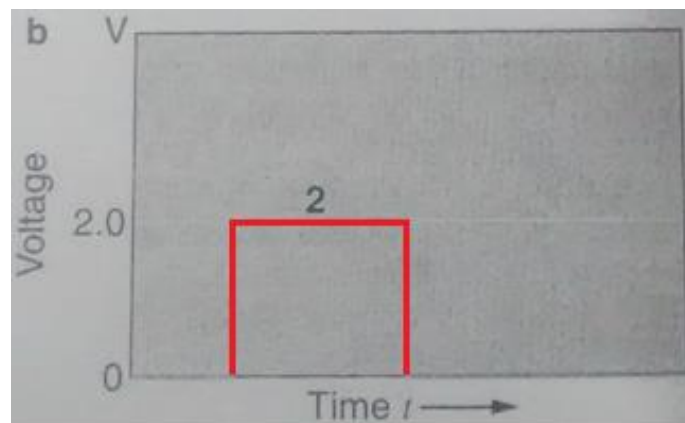

**Figura 2:** Diferencia de señal entre ambas líneas

Fuente: Bosch Automotive Handbook

- Ambas líneas usan diferentes niveles de voltajes. El voltaje que se utiliza en ambos cables es:
 

Bit dominante (0):	CAN High = 3.5 V;	CAN Low = 1.5 V
Bit recesivo (1):	CAN High = 2.5 V;	CAN Low = 2.5 V
- Este cable tiene como terminadores de la línea una impedancia de 120  $\Omega$  con el objetivo de evitar ondas reflejadas que puedan convertir al bus en una antena.

- El sistema de Bus CAN puede actuar a una velocidad máxima de hasta 1 Megabyte por segundo con una longitud máxima de cableado de 40 metros. La longitud máxima del bus puede ser de hasta 1000 metros actuando a una velocidad de 40 Kilobytes por segundo.
- En el uso de automóviles se suelen usar velocidades comprendidas entre los 125 y los 500 Kb/s pudiendo medir el cableado entre los 100 y los 500 metros de máximo aproximadamente.

### 2.3 Capas del Bus CAN

El sistemas de Bus CAN se encarga de dos niveles o capas del conocido como modelo OSI (del inglés *Open System Interconnection*) para las comunicaciones en redes, en concreto las dos más bajas, la capa física y la capa de enlace de datos (Figura 3).

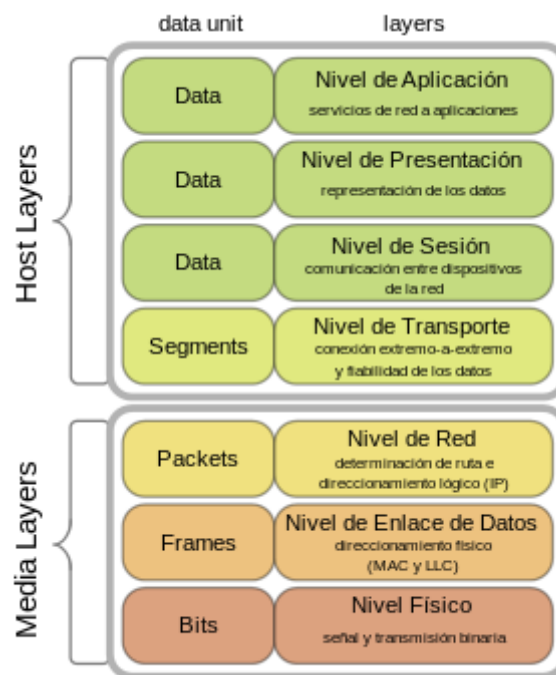

**Figura 3:** Capas del modelo OSI

Fuente: [https://es.wikipedia.org/wiki/Modelo\\_OSI](https://es.wikipedia.org/wiki/Modelo_OSI)

La capa física del Bus CAN es la responsable de establecer el medio por el cual debe ser transmitido el mensaje entre los distintos nodos de la red. En un principio no se establecieron las características de esta capa física por lo que había varias posibilidades a la hora de escoger el medio o los niveles eléctricos de transmisión. Más tarde este problema fue subsanado mediante la creación de los estándares ISO 11898-2 para aplicaciones de alta novedad y el ISO 11519/11898-3 para las de baja velocidad.

#### Estándar de alta velocidad (ISO 11898-2).

Es el que se usa en los automóviles para controlar su motor e interconectar las distintas unidades de control en él puede tener una velocidad de hasta 1 Mbyte/s, está compuesto por un par de cables trenzados y la comunicación en este bus fluye en ambos sentidos por lo que debe haber en ambos extremos un cierre mediante una resistencia de 120  $\Omega$ , sus diferentes niveles lógicos son:

- Bit dominante (0): CAN\_H = 3.5 V      CAN\_L = 1.5 V
- Bit recesivo (1): CAN\_H = 2.5 V      CAN\_L = 1.5 V

## Estándar de baja velocidad (ISO 11529(11898-3).

Este estándar es el utilizado normalmente para la comunicación de los otros dispositivos del vehículo como las luces, control asientos etc. Posee una velocidad de hasta 125 Kbyte/s. A diferencia del bus descrito anteriormente de alta velocidad este bus necesita dos resistencias en cada uno de sus transceptores, RTH para el CAN\_H y RTL para el CAN\_L la suma de todas estas resistencias en paralelo debe estar en el rango comprendido entre 100 y 500  $\Omega$ , sus niveles lógicos son:

- Bit dominante (0):    CAN\_H = 3.5 V            CAN\_L = 1.5 V
- Bit recesivo (1):    CAN\_H = 0 V             CAN\_L = 5 V

La capa de enlace de datos es la que se encarga del acceso al medio y el control lógico y se divide en dos niveles:

- Nivel LLC (del inglés *Logical Link Control*): Este subnivel tiene como misión filtrar los distintos mensajes de la red, es decir, decidir que mensajes recibidos del subnivel MAC se aceptan y también puede notificar una sobrecarga en el bus así como proporcionar los medios para el propio restablecimiento de la línea.
- Nivel MAC (del inglés *Medium Acces Control*): Este subnivel es el núcleo del protocolo CAN, en él se reciben los mensajes transmitidos por el medio físico y los presenta al subnivel LLC, también es el responsable de la trama de mensajes así como de su arbitraje, chequeo de posibles errores y señalización de estos. Además, en este subnivel se decide si un nuevo mensaje puede ser transmitido a la red dependiendo de si está ocupada o no.

## 2.4 Formato de trama

La información transmitida por el bus can se dividen en 4 tramas, que nos permite llevar el mensaje adecuado al módulo adecuado. Estas cuatro tramas son:

- Trama de datos: Este mensaje se subdivide a su vez en varios campos (Figura 4).
  - Inicio de trama (SQF): El sistema se inicia mediante un bit dominante con el propósito de sincronizar los distintos nodos cuando se produce el flanco negativo.
  - Arbitraje: Este campo se compone de 11 bits y el bit RTR y se usa como identificador del mensaje, cuanto más bajo sea el número del identificador mayor es la prioridad del mismo y antes es introducido en mensaje en la línea. El bit RTR sirve para indicar si el mensaje contiene datos mediante la utilización de un bit dominante (RTR -> 0) o si se trata de una trama remota con un bit recesivo (RTR -> 1). La trama de datos siempre tiene prioridad con respecto a la trama remota.
  - Control: Esta parte de la trama de datos tiene carácter informativo del mismo campo de datos y se compone de 6 bit. El primer bit conocido como IDE identifica el tipo de trama, si es un '0' se trata de una trama estándar *BasicCan* de 11 bit y si es un '1' es una trama alargada *PeliCan* de 29 bit. El segundo bit es un bit recesivo conocido como RB0. Los últimos 4 bit, DLC, sirven para indicar el número de bytes que componen el campo de datos, que pueden ser de 0 a 8.
  - Datos: Compuesto de 0 a 8 bytes (64 bits), este campo contiene el mensaje a transmitir entre los diferentes módulos.

- Aseguramiento (CRC): Trama compuesta por 16 bit, los 15 primeros son para la detección de errores entre los módulos el último de ellos es un bit recesivo que delimita el campo de aseguramiento.
- Confirmación (ACK): Este campo se compone de dos bit y su objetivo es la comprobación de que el mensaje ha sido enviado sin ningún error por parte del emisor. Los dos bit son emitidos como recesivos (marcan un 1), los módulos que reciben el mensaje correctamente cambian el primer bit de recesivo a dominante (marca un 0). De esta forma el emisor comprueba que su mensaje ha sido enviado correctamente.
- Fin de trama (EOF): Para finalizar el mensaje el módulo manda una cadena de 7 bit recesivos.
- Espaciado entre tramas (IFS): Entre trama y trama hay 3 bit recesivos.

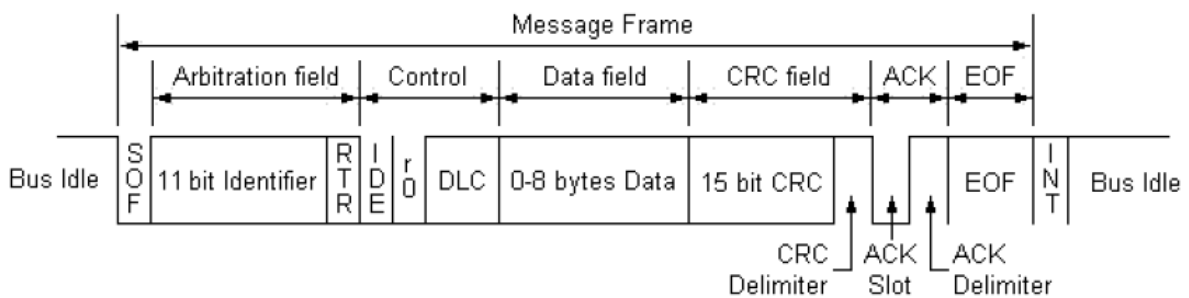

**Figura 4:** Composición trama de datos.

- Trama de petición o remota:

Es una trama similar a la trama de datos pero en este caso es el módulo receptor el que pide al módulo transmisor que le envíe la información. Tanto la trama de datos como la trama remota tienen el mismo identificador y son iguales en su estructura, solo se diferencian en el bit RTR, en el caso de la trama remota es recesivo y en la trama de datos dominante.

- Trama de error:

Esta trama es generada por cualquiera de los nodos para informar a todos los demás de algún tipo de error, está dividida a su vez en dos campos el indicador del error y el delimitador del error.

El indicador del error consta de 6 bit sucesivos que serán todos dominantes si el nodo está en estado de error "activo" pudiendo ser hasta 12 bit, detrás de este indicador irá el delimitador del error compuesto por 8 bits recesivos. Esta secuencia de bit dominantes provoca el error en los demás nodos haciendo que se generen tramas de error en la comunicación y el nodo que ha detectado el problema reintentará transmitir el mensaje.

Si por el contrario el estado del nodo es de error "pasivo", el indicador del error del nodo transmitirá 6 bits recesivos, seguidos a continuación por el delimitador del error que volverán a ser 8 bits recesivos. La transmisión de una trama de error "pasivo" no afecta a ningún nodo en la red hasta que el propio nodo que transmite el error lo detecta.

- Trama de sobrecarga:

Esta trama es generada por cualquier nodo del bus, cuando no se encuentra en condiciones para la recepción de un nuevo mensaje. Para ello el nodo puede enviar hasta dos tramas de sobrecarga que hacen que el nuevo mensaje tarde más en llegar y pueda tener el nodo tiempo a estar disponible para recibirlo correctamente.

Para llevar a cabo este objetivo la trama de sobrecarga tiene el mismo formato que una trama de error "activo", es decir, un indicador de sobrecarga de 6 bits dominantes que pueden llegar a ser hasta 12 bits debido a los generados por los demás nodos, seguido de un delimitador de sobrecarga compuesto por 8 bits recesivos. La trama de sobrecarga solo puede ser generada entre el espacio existente entre las diferentes tramas.

- Espacio entre tramas:

Como se ha descrito en el apartado de trama de datos, entre cada trama diferente tiene que haber un espacio entre tramas que está compuesto por 3 bits recesivos. Cuando un nodo acaba de recibir este espacio entre tramas el bus puede enviar una nueva trama o mantenerse inactivo. Si está en estado de error "activo" el nodo puede enviar una nueva información o el bus permanecerá en reposo, si el nodo está en estado de error "pasivo" deberá esperar la secuencia adicional de 8 bits antes de poder enviar un nuevo mensaje a los demás nodos.

## 2.5 Errores.

Debido a que este protocolo de comunicaciones fue creado para el uso en un entorno muy hostil como lo es un automóvil, se trata de un modelo muy fiable incluso en los entornos de ruidos más extremos, esto es en parte debido a la gran variedad de mecanismos que posee el sistema para detectar errores. Esta detección permite al protocolo retransmitir el mensaje hasta que sea recibido con éxito. Si el error se produce por el mal funcionamiento de uno de los dispositivos, es decir, un alto porcentaje de las tramas que envía son erróneas, se producirá el llamado error de aislamiento, el protocolo impide así que este mal funcionamiento condicione a todo el sistema.

### Tipos de errores:

- Error de bit: Se produce cuando un dispositivo envía una trama y recibe algún bit inverso con respecto a la trama enviada, excepto que este bit sea el de arbitraje o el de reconocimiento. No se considera un error de bit cuando se detecta un bit dominante por un nodo en estado de error pasivo que transmite una trama de error pasivo.
- Error de CRC (del inglés *Cyclic Redundant Code*): Cuando un nodo al recibir la trama hace el cálculo del campo CRC y no coincide con el recibido se produce el error de CRC. Este error permite detectar errores de transmisión por culpa del medio físico que rodea la red como el ruido.
- Error de relleno: Este error se produce cuando en una trama hay 6 bit del mismo valor seguidos, ya que según el protocolo siempre por cada 5 bit seguidos iguales debe incluirse uno diferente.
- Error de forma: Es cuando se recibe un bit de signo contrario en un lugar que debe tener un bit de formato fijo.

- Error de reconocimiento: Este error se produce cuando ningún nodo al recibir la trama cambia a dominante el bit de reconocimiento.

Si un nodo reconoce alguno de estos errores descritos anteriormente, automáticamente se iniciará la transmisión de la trama de error descrita en el subapartado anterior.

Aislamiento de dispositivos debido a errores de transmisión. Un dispositivo puede ser aislado por completo del sistema si se encuentra en alguno de los siguientes estados:

- Estado de error pasivo: Un nodo en este estado no puede transmitir y participar en el sistema. Hasta que no reciba una secuencia de bits recesivos y solo señalara errores mediante una trama de error pasiva.
- Anulado: Un nodo en este estado no participa en la comunicación ya que su transceptor estará desactivado.



### 3. Descripción del vehículo

El vehículo sobre el que vamos a evolucionar su sistema de comunicaciones es un Peugeot 106 fase II del año 2001 (Figura 5), en sí, el problema que se presenta es un proyecto normal que cualquier equipo de ingenieros llevarían a cabo para la evolución de dicho modelo a su nueva versión.



**Figura 5:** Peugeot 106 fase II

*Fuente: Guía de utilización Peugeot 106*

Todos los automóviles son ordenados en diferentes segmentos y cada marca tiene un modelo específico para cada segmento, aunque no siempre los completan todos, los diferentes automóviles se clasifican en un segmento u otro dependiendo principalmente de su tamaño y por lo tanto también por su precio y potencia. Este modelo en concreto pertenece al llamado segmento B que son vehículos con espacio para 4 adultos y un niño, estos vehículos suelen ser de tamaño pequeño (Figura 6) y un precio moderado. Con la aparición reciente de los microcoches, los vehículos del segmento B han aumentado su tamaño, por lo que actualmente un coche del tamaño del Peugeot 106 estaría ubicado dentro del segmento A, de hecho su sucesor el Peugeot 107, pertenece a este segmento. Estos coches tienen un precio todavía más reducido, lo que será una condición muy a tener en cuenta a la hora de realizar la evolución en su sistema de comunicaciones, ya que deberán ser incluidos nuevos sistemas pero habrá que estudiar cual es el precio de cada uno y si realmente merece la pena incluirlo o no dependiendo de su coste.

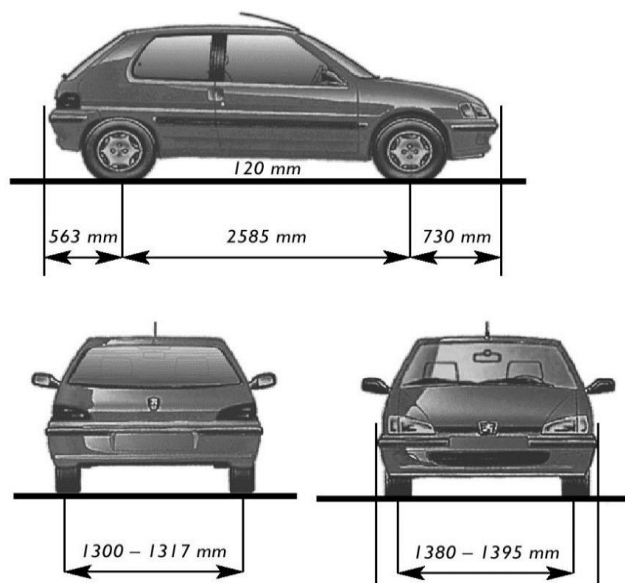

**Figura 6:** Medidas generales Peugeot 106 fase II

El modelo sobre el que se va a trabajar es el que posee el motor de 1124 cm<sup>2</sup> de inyección de gasolina de la clase de motores de PSA (Peugeot-Citröen) TU, del tipo *Mono-Jetronic*. Esto es un punto a tener en cuenta en el proyecto porque según el tipo de motor necesitará una sensorización y unos actuadores u otros. Existen la versión de 3 puertas y la de 5, en este caso el estudio es para la versión de 3 puertas, lo cual supone un ahorro importante de dispositivos y sistemas a añadir. El sistema de comunicaciones que el vehículo poseía de series es el llamado VAN (del inglés *Vehicle Area Network*), desarrollado por PSA. En la tabla 1 se muestra la ficha técnica del vehículo:

**Tabla 1:** Ficha técnica Peugeot 106 Fase II

Prestaciones y consumos	
Velocidad máxima (km/h)	164
Aceleración 0-100 km/h (s)	14,9
Consumo urbano (l/100 km)	8,0
Consumo extraurbano (l/100 km)	5,0
Consumo medio (l/100 km)	6,1
Emisiones de CO <sub>2</sub> (gr/km)	145
Normativa de emisiones	Euro 3
Dimensiones, peso y capacidades	
Tipo de Carrocería	Turismo
Número de puertas	3
Largo / ancho / alto (mm)	3678 / 1588 / 1376
Batalla / vía delantera - trasera (mm)	2385 / 1385 – 1305
Coefficiente aerodinámico	0.34
Peso (kg)	890
Combustible Gasolina (litros)	45
Volumen con una fila de asientos disponible (litros)	530
Volumen mínimo con dos filas de asientos disponibles (litros)	215
Número de plazas / Distribución de asientos	5 / 2 + 3
Motor de combustión	
Combustible	Gasolina
Potencia máxima CV - kW / rpm	60 - 44 / 5500
Par máximo Nm / rpm	91 / 3200
Situación	Delantero transversal
Número de cilindros	4 - En línea
Material del bloque / culata	Aluminio / Aluminio
Diámetro x carrera (mm)	72,0 x 69,0
Cilindrada (cm <sup>3</sup> )	1124
Relación de compresión	9,7 a 1
Distribución	2 válvulas por cilindro. Un árbol

	de levas en la culata
Alimentación	Inyección Indirecta
Automatismo de parada y arranque del motor ("Stop/Start")	No
<b>Transmisión</b>	
Tracción	Delantera
Caja de cambios	Manual, 5 velocidades
Desarrollos (km/h a 1.000 rpm)	
1ª	8,1
2ª	14,1
3ª	20,3
4ª	26,2
5ª	32,3
<b>Chasis</b>	
Suspensión delantera (estructura/muelle)	Tipo McPherson / Resorte helicoidal
Suspensión trasera (muelle)	Barra de torsión
Barra estabilizadora (delante/detrás)	Sí / Sí
Frenos delanteros (diámetro mm)	Disco (238)
Frenos traseros (diámetro mm)	Tambor (165)
<b>Dirección</b>	
Tipo	Cremallera
Tipo de asistencia	Eléctrica
Asistencia en función de la velocidad	No
Desmultiplicación en función de la velocidad	No
Desmultiplicación no lineal	No
Dirección a las cuatro ruedas	No
Diámetro de giro entre bordillos	10,1
Vueltas de volante entre topes	3
Neumáticos delanteros	155/70 R13
Neumáticos traseros	155/70 R13
Llantas delanteras	5,0 x 13
Llantas traseras	5,0 x 13

El vehículo lleva una serie de sistemas electrónicos básicos del año en el que fue construido pudiendo añadirle algunos sistemas más como extras. A continuación, se adjunta una lista con los sistemas que posee el vehículo (Tabla 2) que como puede verse son algo escasos comparados con los automóviles actuales.

**Tabla 2:** Sistemas que el vehículo posee de serie

Seguridad y conducción	
Airbag frontal conductor	De serie
Airbag frontal conductor	De serie
Airbag frontal pasajero	De serie
Airbag lateral delantero	Extra
Anclaje asientos infantiles ISOFIX	De serie
Antibloqueo de frenos (ABS)	Extra
Dirección asistida	Extra
Limpia luneta trasera	De serie
Reloj horario analógico	De serie
Tercera luz de freno	De serie
Elementos de confort	
Aire acondicionado	Extra
Cierre centralizado	De serie
Elevavinas eléctricos delanteros	De serie
Mando de apertura a distancia	De serie
Equipo de sonido	
Antena de radio	De serie
Radio con lector de CD	Extra
Radiocasete	Extra

## 4. Sistemas a implementar en el vehículo

Como se puede comprobar en el apartado anterior, el vehículo carece de muchos sistemas obligatorios por norma en la actualidad, así como de otros muchos que cualquier vehículo fabricado actualmente posee y que por lo tanto deben ser añadidos si se quiere que la evolución del automóvil sea competitiva en el mercado actual. Por ello, se han dividido los sistemas a comunicar en el vehículo en los que ya posee y los que van a ser añadidos.

La otra clasificación de estos sistemas ha sido según el bus de comunicaciones al que pertenecen, esto es muy importante a la hora de diseñar el sistema de comunicaciones como se verá más adelante. La elección de cada bus se ha realizado basándose en la relación existente de cada uno de los sistemas. En primer lugar los sistemas meramente informativos y de ocio que no afectan a la conducción como la radio y los termómetros de temperatura. Los sistemas referentes a la comodidad y confort tanto del conductor como de los pasajeros y que pueden influir en la conducción se han incluido en el Bus confort. Todos los sistemas críticos, tanto para el funcionamiento del vehículo (Sistema electrónico del motor), así como los sistemas de seguridad pasiva y activa del pasajero (airbags y ayudas a la conducción), han sido incluidos en el Bus de tracción. Por último, todos los sistemas que muestran información sobre el estado del vehículo en el cuadro de instrumentos del conductor se han unido en el Bus del panel de mando del volante.

### 4.1 Sistemas pertenecientes al bus infotenimiento

#### 4.1.1 Sistemas que posee el vehículo de serie

- Radio: Radio que posee el vehículo a la que se le añadirá lector de CD audio y DVD, con posibilidad de ver videos en la pantalla digital que comparte con el sistema de navegación.

#### 4.1.2 Sistemas nuevos a implementar o mejorar

- Navegador GPS. Este sistema hace uso del sistema GPS para conocer la ubicación del vehículo en cada momento y mediante la base de datos que el navegador posee situar y guiar la conducción del automóvil por las distintas carreteras o calles. También es capaz de calcular la ruta más corta entre dos puntos.
- Termómetro exterior/interior. Termómetros que muestran al usuario la información sobre la temperatura tanto en el exterior del vehículo como en el interior de este.
- Sistema de aparcamiento asistido: Sistema que mediante unos sensores situados tanto en el parachoques delantero como en el trasero, así como en el lateral del vehículo detectan la proximidad de objetos y avisan al conductor mediante testigos luminosos o acústicos del peligro de colisión.
- Avisador cambio de carril involuntario. Sistema que mediante unos sensores infrarrojos detecta el cambio de carril del vehículo al detectar las distintas líneas de separación de carriles. También existen otros tipos de sistemas como los que se ayudan de visión artificial, es decir, una cámara de video situada en el detrás del parabrisas del vehículo o los scanner laser. En este vehículo se emplearan los sensores infrarrojos ya que son la solución más económica. Si se produce un cambio de carril sin que el usuario haya puesto el intermitente correspondiente de cambio de dirección, el sistema avisa al conductor mediante testigos acústicos o luminosos o incluso con la vibración del volante. El sistema tampoco se activara si se pulsa el pedal de freno o el conductor efectúa una maniobra brusca.

## 4.2 Sistemas pertenecientes al bus confort

### 4.2.1 Sistemas que posee el vehículo de serie

- Elevalunas delanteros eléctricos: Mediante el uso de unos motores situados en el interior de la chapa de cada una de las puertas permite al usuario con la pulsación de un interruptor elevar o bajar las ventanillas.
- Sistema de parabrisas delantero y trasero: Sistema que elimina el agua de las lunas delanteras y traseras del vehículo para mejorar la visibilidad en condiciones adversas como lluvia, nieve, niebla etc...El limpiaparabrisas del vehículo posee 3 velocidades para el delantero y una para el trasero con posibilidad de echar agua enjabonada en ambos para mejorar la limpieza de las lunas. Hoy en día los automóviles modernos poseen un sensor de lluvia que mediante el bus de comunicaciones activa los limpiaparabrisas de forma automática, este último automatismo será implementado en el vehículo.
- Claxon. Sistema eléctrico que emite, mediante una bocina, un mensaje acústico para advertir de algún peligro a los demás conductores o peatones.
- Luces: En la parte delantera del vehículo están las luces de posición (cortas), las luces de carretera (largas) y las luces de niebla además de los indicadores de cambio de dirección (intermitentes). En la parte trasera del vehículo se disponen de luz de posición, luz de frenado, luz de marcha atrás, luz niebla, indicadores cambio dirección así como la luz de matrícula. El usuario puede seleccionar algunas de estas luces mediante los mandos en la columna de dirección y otras se activan automáticamente mediante el pedal de freno o al seleccionar marcha atrás en la palanca de cambios. Se va a incluir un sensor detector de luz que activa las luces de posición tanto trasera como delantera cuando este detecta la falta de luminosidad. El sistema también posee testigos luminosos en el panel de mando que indican al usuario que luces están encendidas.
- Cierre centralizado: Consiste en una unidad central que ordena a todos los motores situados en cada una de las puertas del vehículo que cierren o abran las cerraduras del vehículo de forma simultánea. Las órdenes de esta unidad central del cierre centralizado son transmitidas mediante el BUS CAN a cada uno de los pequeños motores que poseen las cerraduras del vehículo.
- Luna trasera calefactada: La luna trasera del vehículo posee de serie unas resistencias que mediante la pulsación de un botón en el panel de mando hacen que desaparezca el vaho en esta luna para mejorar la visibilidad del vehículo.
- Control luces encendidas: El vehículo lleva de serie un sistema que avisa mediante un pitido intermitente que están las luces encendidas si el vehículo se encuentra con el motor parado.
- Botón señal emergencia: Mediante la pulsación de un botón en el panel por parte del usuario, se encienden ambos intermitentes así como los indicadores en el panel., para avisar de una parada de emergencia o señalar algún peligro en la carretera a los demás conductores.
- Luz interior vehículo: El usuario mediante la pulsación de un interruptor puede encender una luz en el interior del vehículo para tener mayor visibilidad de este.

#### 4.2.2 Sistemas nuevos a implementar o mejorar

- Control puertas abiertas: Sistema que mediante unos testigos luminosos o eléctricos avisa al conductor y los pasajeros que alguna de las puertas no está cerrada completamente. Para ello un sensor situado en cada una de las puertas comprueba si estas están cerradas correctamente.
- Retrovisores exteriores eléctricos: Sistema que permite al usuario ajustar ambos retrovisores del vehículo mediante un mando analógico de 4 u 8 direcciones. El movimiento de estos se produce mediante dos pequeños motores situados detrás de los espejos.
- Asiento del conductor y el pasajero con ajuste eléctrico: Sistema que permite al usuario mediante un mando situar el asiento más o menos cerca con respecto al volante o al salpicadero en el caso del copiloto, así como el ángulo del respaldo con respecto al suelo del vehículo. Esto es posible mediante dos pequeños motores situados en cada uno de los asientos delanteros del vehículo.
- Sistema de calefacción y aire acondicionado con climatizador. Consiste en la climatización el interior del vehículo. El vehículo posee un sistema muy elemental en el que se selecciona la velocidad del ventilador y la potencia del aire acondicionado. Va a ser añadido un sistema de climatización “*climatic*” (unizona), ya que se trata de un vehículo pequeño, en el que el usuario puede elegir la temperatura a la que quiere que esté el interior del vehículo haciendo el sistema mucho más intuitivo.
- Asientos térmicos. Este sistema permite la calefacción de la banqueta, así como del respaldo de cada uno de los asientos del vehículo mediante una esterilla de fibra de carbono.
- Techo Solar. Sistema consistente en una abertura en el techo del vehículo mediante un motor.

#### 4.3 Sistemas pertenecientes al bus de tracción

##### 4.3.1 Sistemas que posee el vehículo de serie

- Airbags. El airbag es un sistema de seguridad pasiva que consiste en amortiguar con bolsas inflables en caso de impacto del vehículo el choque de los ocupantes contra el volante, el salpicadero, el parabrisas o los laterales del vehículo. Para ello el sistema detecta que ha habido un golpe mediante unos sensores de aceleración y activa los distintos accionamientos de inflado de las bolsas en milésimas de segundo. El sistema posee además la posibilidad de desactivarlo en el asiento del copiloto para poder incluir una sillita de niño, además de un sensor de presión similar al del sistema de aviso de cinturones para que no se active el sistema del pasajero si no se encuentra ninguna persona en el momento del impacto. Serán implementados en el vehículo dos airbags frontales para los ocupantes delanteros del coche así como otros dos laterales.
- Sistemas electrónicos motor: El motor de gasolina que posee el vehículo es del tipo inyección monopunto *Mono-Jetronic*, este sistema se creó debido a la necesidad de abaratar costes en vehículos utilitarios de bajo precio, como el que se ocupa en este estudio, y también para poder cumplir las nuevas normas de anticontaminación que cada vez eran más restrictivas. La peculiaridad de este sistema con respecto a los del tipo multipunto es que posee un único inyector situado justo antes de la mariposa de gases, esto último es otra de las diferencias con respecto a los multipunto en los que los inyectores están situados después de la mariposa. La Unidad de Control de Motor, ECU (del inglés *Engine Control Unit*), es la

encargada de la dosificación del combustible, para esta regulación la unidad de control se sirve de la información recibida por los diferentes sensores que posee el motor (Figura 7).

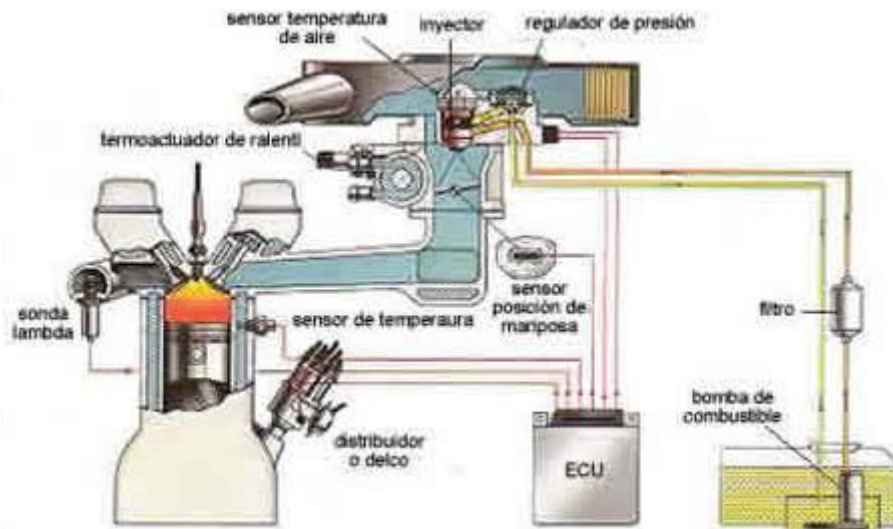

**Figura 7:** Motor de inyección del tipo Mono-Jetronic

- **Encendido eléctrico motor.** Sistema se usa para vencer la resistencia inicial de los distintos elementos cinemáticos del motor. El sistema se compone del motor de arranque el interruptor la batería eléctrica del coche y del cableado, en este caso el BUS CAN. El usuario pone en marcha este motor de arranque con la electricidad suministrada por la batería simplemente girando la llave de puesta en marcha.
- **Sonda lambda:** Sistema que se usa para medir el nivel del oxígeno del aire tanto antes de entrar en el catalizador como al salir de este, según el grado de riqueza de la mezcla el sistema actúa modificando la inyección electrónica del motor con el fin de regular la entrada de gasolina al cilindro y mantener la relación lo más próxima a 1/14,7.
- **Dirección asistida:** Es del tipo eléctrico, ya que esta es la más común en vehículos de pequeño tamaño como el que se estudia en este caso. En este tipo de dirección se elimina todo el circuito hidráulico y sus componentes y se sustituye por un motor eléctrico que acciona una reductora que a su vez mueve la cremallera de dirección. Los componentes de este sistema son la unidad central de servodirección el motor eléctrico descrito anteriormente, así como un sensor que detecta el ángulo de dirección del volante y otro sensor para el cálculo del par de dirección.

#### 4.3.2 Sistemas nuevos a implementar o mejorar

- **Control cinturones:** Sistema que avisa al conductor o algunos de los pasajeros que debe abrocharse el cinturón. El sistema de control de cinturones posee dos tipos de sensores, por un lado unos sensores en la hebilla de cada uno de los cinturones y por otro lado unos sensores de presión en cada uno de los asientos que detectan si hay o no un pasajero en ese asiento. Si se detecta en el sensor de la hebilla que el cinturón no está puesto y el sensor de presión detecta que hay una persona, un testigo acústico y luminoso avisaran al conductor y los pasajeros que deben abrocharse el cinturón.



- Sistema ABS (del alemán *Antiblockiersystem*): El sistema de antibloqueo de ruedas, es hoy en día de uso obligatorio en todos los turismos fabricados en Europa desde el año 2004. Consiste en una serie de sensores que miden las revoluciones de cada rueda y envían la información a una unidad central, si la unidad central detecta que alguna rueda baja sus rpm actúa reduciendo la presión realizada sobre los frenos evitando que la rueda se bloquee lo que haría perder adherencia y tiempo de frenado al vehículo.
- Sistema de frenado de emergencia BAS (del inglés *Brake Assist System*): Basado en el sistema ABS y utilizando sus sensores y su unidad central el sistema hace los cálculos necesarios para frenar en el menor espacio posible regulando la presión de los frenos. Cuando se detecta que el conductor pulsa el pedal de freno de forma brusca.
- Control de tracción ASR (del inglés *Anti-Slip Regulation*): Este sistema hace uso de los sensores y la unidad central del sistema ABS para que, si en una aceleración del vehículo alguna de las ruedas revoluciona más rápido que el resto baje su velocidad de revolución con el fin de ganar adherencia en las salidas del vehículo y que este no patine. Hay 3 formas para reducir la velocidad de la rueda: retardar o suprimir la chispa a uno o más cilindros, reducir la inyección de combustible a los cilindros o simplemente frenar la rueda que está perdiendo adherencia.
- Control estabilidad ESP (del alemán *Elektronisches Stabilitätsprogramm*): Posee sensores de alta presión, sensor Angulo giro volante, sensor de magnitud de giro o viraje y sensor de aceleración transversal. El sistema sirve para evitar derrapes en el paso por curva frenado automáticamente e individualmente las ruedas del vehículo.

#### 4.4 Sistemas pertenecientes al bus del panel de mando del volante

- Fecha/Hora: Indicador digital que indica al usuario la fecha y la hora.
- Cuentakilómetros: Sistema que mediante un sensor de velocidad en la transmisión del vehículo indica los kilómetros totales o los kilómetros de un viaje realizados por el vehículo mediante un indicador digital en el cuadro de instrumentos.
- Indicador velocidad: Este sistema usa el mismo sensor que el cuentakilómetros y mediante el número de revoluciones por minuto de la transmisión indica al usuario la velocidad total del vehículo en Kilómetros/Hora mediante un indicador analógico.
- Cuentarrevoluciones: Sistema que muestra las revoluciones por minuto a las que giran los distintos cilindros de motor.
- Medidor fuel: Sistema que indica al conductor el nivel de gasolina en el depósito, para ello se hace uso de un sensor que mide el nivel de la gasolina en el depósito.
- Medidor temperatura del líquido de refrigeración: Sistema que indica al usuario si el motor está sobrecalentado mediante la medición de la temperatura del líquido refrigerante de este. Si la temperatura sobrepasa el límite establecido se encenderá un testigo luminoso en el cuadro de instrumentos del vehículo.
- Presión aceite motor: Sistema que por medio de un sensor de presión mide el nivel de aceite en el motor del vehículo. Si la presión del aceite es insuficiente, por lo que el nivel será bajo, se encenderá un testigo luminoso en el cuadro de instrumentos del vehículo.

- Carga batería. Testigo que indica mediante un testigo luminoso en el cuadro de instrumentos si la carga de la batería es baja o está agotada.
- Autodiagnos motor: El testigo luminoso situado en el cuadro de instrumentos de autodiagnos indica que hay o hubo algún malfuncionamiento de algún sistema que compone al motor (inyección, encendido, admisión) pero también se enciende cuando la parte mecánica del motor ha sufrido algún ligero daño que puede estar comenzando a generarse. Este testigo se encenderá cuando hay algún código de avería OBD.
- Aviso freno de mano. Testigo luminoso que indica al conductor si el freno de mano está activado.
- Testigos luces: Compuesto por varios testigos luminosos indican al conductor si están activadas las luces de posición las luces de carretera o las luces de niebla, así como los indicadores de cambio de dirección.

## 5. Arquitectura del sistema

### 5.1 Descripción

Se ha seleccionado un total de 4 buses principales, siguiendo la estructura más recomendada por los propios fabricantes más una línea destinada para el conector de diagnóstico (Sistema OBD), Estos buses van todos conectados a una centralita general con un *Gateway*. Este *Gateway* es necesario para poder transmitir mensajes entre buses de distintas velocidades. A parte de la centralita general se disponen de varias centralitas más en cada bus, las cuales manejan uno o más sistemas del vehículo. A estas centralitas irá la información procedente de los sensores y los mandos del vehículo y darán las órdenes para que funcionen los diferentes actuadores, a través de ellas también conoceremos si se produce algún fallo en las comunicaciones, o en los sensores y actuadores del vehículo. Esta información será transmitida a través del Bus hasta la centralita general que mediante la *Gateway*, anteriormente descrita, transmitirá la información a los demás buses y la almacenará para que posteriormente pueda ser revisada por el usuario mediante el conector de diagnóstico OBD (del inglés, *On Board Diagnostics*). Esto se realizara gracias a que la Gateway funciona como un dispositivo que traduce la información de los protocolos SAE J1939 que codifica las señales de los diferentes dispositivos y el protocolo ISO 9141 usado para transmitir los mensajes de autodiagnos.

A continuación, se muestran tanto el esquema general del sistema de buses del vehículo (Figura 8), así como un esquema detallado de cada bus (Figuras 9,10,11 y 12) en el cuál se muestran tanto las centralitas principales del bus así como los distintos sensores, interruptores, mandos y actuadores de cada uno de los sistemas. Las restricciones que hay que tener en cuenta debido al protocolo utilizado no se pueden poner más de 30 nodos o superar los 40 metros en cada bus.

#### Esquema general

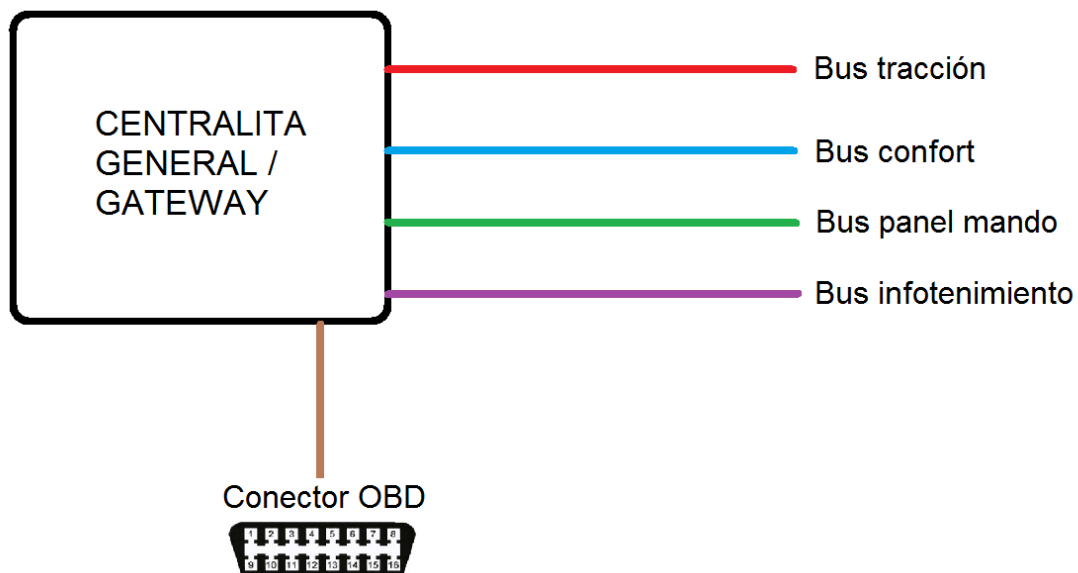

**Figura 8:** Esquema general del sistema

## 5.2 Arquitectura del bus infotenimiento

En este bus están incluidos tanto la radio como los termómetros del vehículo así como los sistemas de aparcamiento asistido y cambio involuntario de carril. Estos dos últimos, así como los termómetros han sido incluidos en este bus porque van a hacer uso de un *display* especial que compartirá con la propia radio del vehículo. La velocidad de este bus será la mayor posible, ya que hay recursos como pantallas de video (GPS) que necesitan una alta velocidad por tanto no se podrán ajustar los dispositivos de este bus al protocolo SAE J1939 y su velocidad será de 1 Mbyte/s.

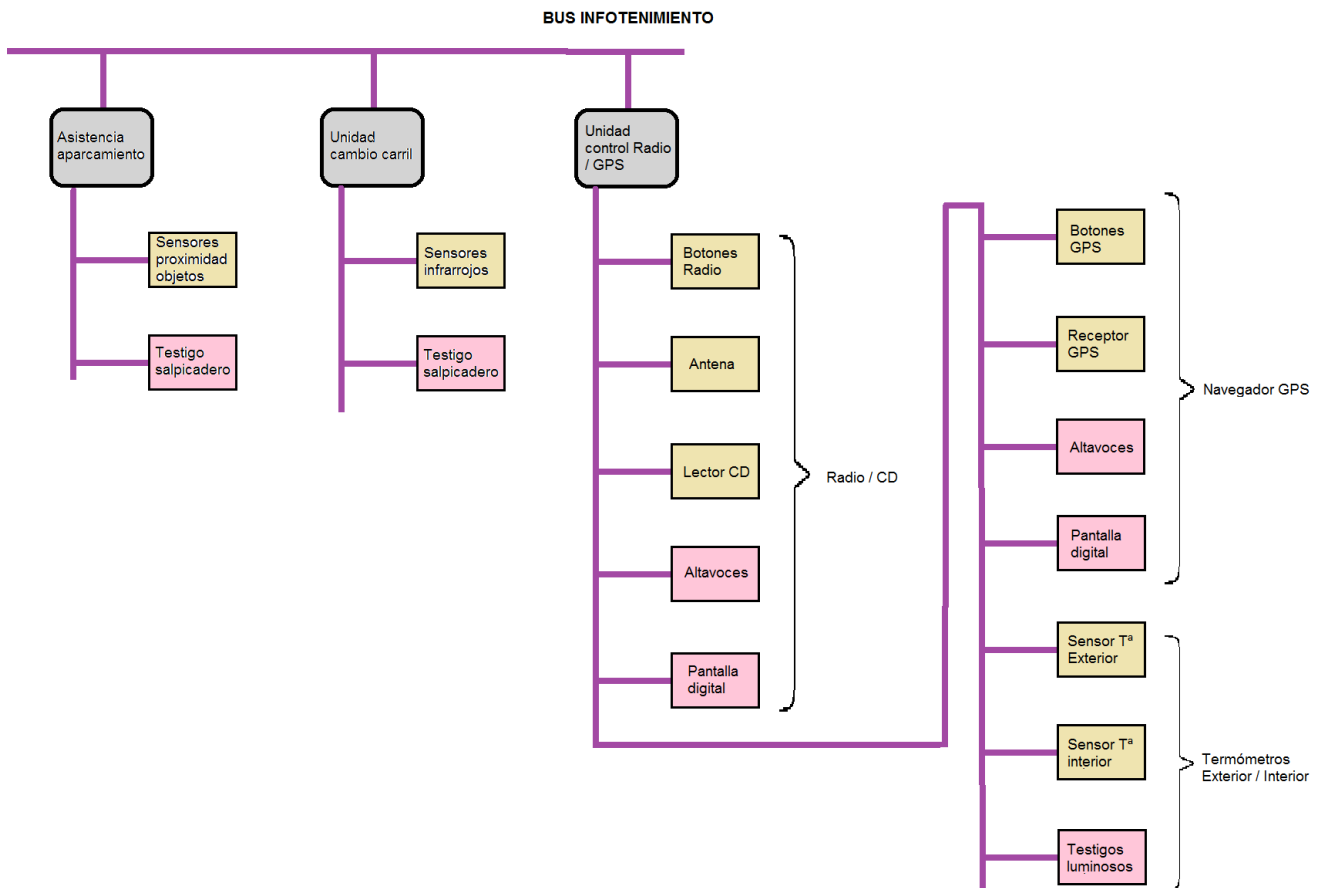

**Figura 9:** Esquema del bus infotenimiento

**Tabla 3:** Arquitectura Bus de Infotainment

BUS INFOTENIMIENTO			
Dispositivo	Tipo	Número Nodos	Sistema
Unidad control radio/GPS	Centralita	9	
Botones radio	Mando/Interruptor	1	Radio/CD-DVD
Antena	Sensor	1	Radio/CD-DVD
Lector CD	Sensor	1	Radio/CD-DVD
Altavoces	Actuador	2	Radio/CD-DVD
Pantalla digital	Actuador	1	Radio/CD-DVD
Botones GPS	Sensor	1	Navegador GPS
Receptor GPS	Sensor	1	Navegador GPS
Altavoces	Actuador	2	Navegador GPS
Pantalla digital	Actuador	1	Navegador GPS
Termómetro exterior	Sensor	1	Termómetros interior/exterior
Termómetro interior	Sensor	1	Termómetros interior/exterior
Testigo luminoso (Pantalla digital)	Actuador	1	Termómetros interior/exterior
Unidad control asistencia aparcamiento	Centralita	9	
Sensor proximidad objetos	Sensor	8	Asistencia aparcamiento
Testigo salpicadero	Actuador	1	Asistencia aparcamiento
Unidad control cambio carril	Centralita	5	
Sensores infrarrojos	Sensor	4	Cambio carril involuntario
Testigo salpicadero	Actuador	1	Cambio carril involuntario

### 5.3 Arquitectura del bus confort

Este es el bus de mayor extensión de los cuatro a implementar, debido a que en él se recogen todos los sistemas que a día de hoy no pueden faltar en cualquier vehículo que se fabrique, ya sea por las distintas normas internacionales o por la propia exigencia del mercado. Estos sistemas son los que hacen más fácil y cómoda la conducción del vehículo por parte del conductor como la estancia por parte de los pasajeros, siendo algunos de ellos esenciales como por ejemplo el sistema de luces del vehículo. Para poder recoger toda la información de todos los dispositivos y poder transmitirla a los distintos actuadores se ha diseñado una red con 5 centralitas diferentes, agrupando entre sí aquellos sistemas que se encuentran más próximos en el vehículo o que tienen cierta relación en sus funciones. La velocidad en este bus será de 250 Kbyte/s, ya que es la que marca el SAE J1939.



Figura 10: Esquema del Bus confort

**Tabla 4:** Arquitectura Bus de Confort

BUS CONFORT			
Dispositivo	Tipo	Número Nodos	Sistema
Unidad control puerta del conductor	Centralita	12	
Sensor cierre puerta	Sensor	1	Control cierre puertas
Testigo salpicadero	Actuador	1	Control cierre puertas
Mando 4 direcciones	Mando/Interruptor	2	Retrovisores eléctricos
Motor 4 direcciones	Actuador	2	Retrovisores eléctricos
Interruptor asiento adelante/atrás	Mando/Interruptor	1	Asiento eléctrico
Interruptor ángulo asiento adel/atrás	Mando/Interruptor	1	Asiento eléctrico
Motor asiento adelante/atrás	Actuador	1	Asiento eléctrico
Motor ángulo adelante/atrás	Actuador	1	Asiento eléctrico
Interruptor subida/bajada	Mando/Interruptor	1	Elevalluna eléctrico
Motor elevalluna	Actuador	1	Asiento eléctrico
Unidad control puerta del pasajero	Centralita	8	
Sensor cierre puerta	Sensor	1	Control cierre puertas
Testigo salpicadero	Actuador	1	Control cierre puertas
Interruptor asiento adelante/atrás	Mando/Interruptor	1	Asiento eléctrico
Interruptor ángulo asiento adel/atrás	Mando/Interruptor	1	Asiento eléctrico
Motor asiento adelante/atrás	Actuador	1	Asiento eléctrico
Motor ángulo adelante/atrás	Actuador	1	Asiento eléctrico
Interruptor subida/bajada	Mando/Interruptor	1	Elevalluna eléctrico
Motor elevalluna	Actuador	1	Asiento eléctrico
Unidad control climatic	Centralita	11	
Sensor de alta presión	Sensor	1	Climatización
Sensor T <sup>a</sup> salida evaporador	Sensor	1	Climatización
Sensor T <sup>a</sup> agente frigorífico	Sensor	1	Climatización
Mando temperatura interior	Mando/Interruptor	1	Climatización
Motor ventilador	Actuador	1	Climatización
Válvula reguladora compresor	Actuador	1	Climatización
Testigo luminoso temperatura	Actuador	1	Climatización
Interruptor diversos grados temperatura	Mando/Interruptor	2	Asientos térmicos
Resistencias térmicas asiento	Actuador	2	Asientos térmicos
Unidad control columna dirección	Centralita	30	
Mando volante limpiaparabrisas	Mando/Interruptor	1	Limpiaparabrisas
Sensor lluvia	Sensor	1	Limpiaparabrisas
Motor limpiaparabrisas delantero	Actuador	1	Limpiaparabrisas

Motor limpiaparabrisas trasero	Actuador	1	Limpiaparabrisas
Interruptor claxon	Mando/Interruptor	1	Claxon
Bocina	Actuador	1	Claxon
Mando volante luces	Mando/Interruptor	1	Luces
Sensor luz	Sensor	1	Luces
Interruptor marcha atrás	Mando/Interruptor	1	Luces
Interruptor luces freno	Mando/Interruptor	1	Luces
Bombillas y leds	Actuador	20	Luces
Unidad control confort	Centralita	18	
Receptor señal infrarroja mando	Sensor	1	Cierre centralizado
Motor puerta conductor	Actuador	1	Cierre centralizado
Motor puerta copiloto	Actuador	1	Cierre centralizado
Motor puerta maletero	Actuador	1	Cierre centralizado
Interruptor abrir/cerrar techo	Mando/Interruptor	1	Techo solar
Motor abrir/cerrar techo	Actuador	1	Techo solar
Interruptor activar/desactivar luna térmica	Mando/Interruptor	1	Luna térmica trasera
Relé luna térmica	Actuador	1	Luna térmica trasera
Testigo luna térmica activa	Actuador	1	Luna térmica trasera
Testigo acústico	Actuador	1	Control luces encendidas
Interruptor señal emergencia	Mando/Interruptor	1	Botón señal emergencia
Luces intermitentes	Actuador	4	Botón señal emergencia
Testigo luminoso	Actuador	1	Botón señal emergencia
Interruptor luz interior	Mando/Interruptor	1	Luz interior vehículo
Luz interior vehículo	Actuador	1	Luz interior vehículo

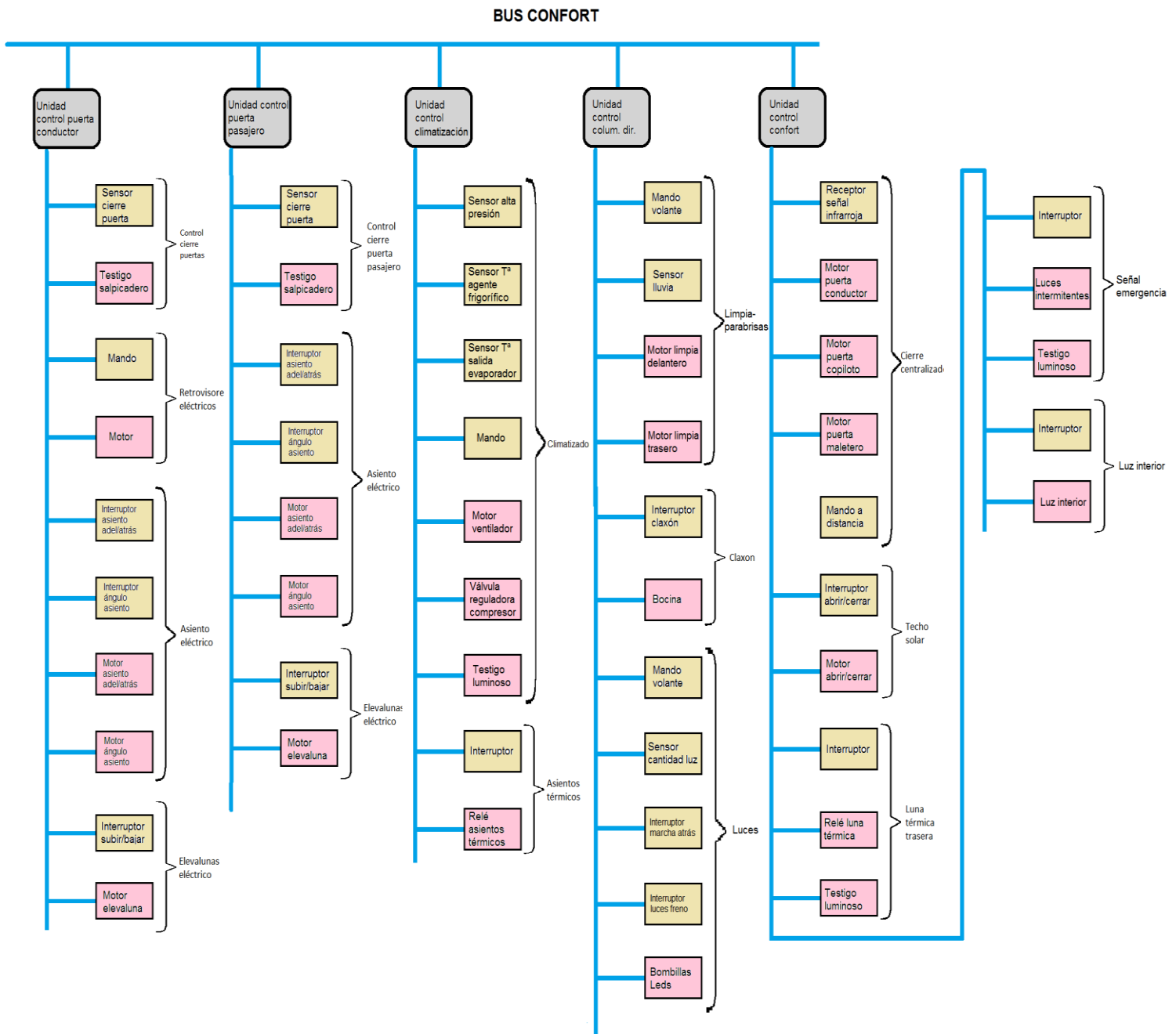

## 5.4 Arquitectura del bus tracción

El bus de tracción contiene todos los sistemas referentes al propio funcionamiento del vehículo, como su motor y su sistema de tracción y dirección asistida, así como sus sistemas de seguridad, principalmente las ayudas a la conducción y los sistemas de airbags y cinturones. La velocidad en este bus será de 250 Kbyte/s, ya que es la que marca el SAE J1939. Para controlar estos sistemas se van a necesitar 4 unidades de control como podemos ver a continuación:

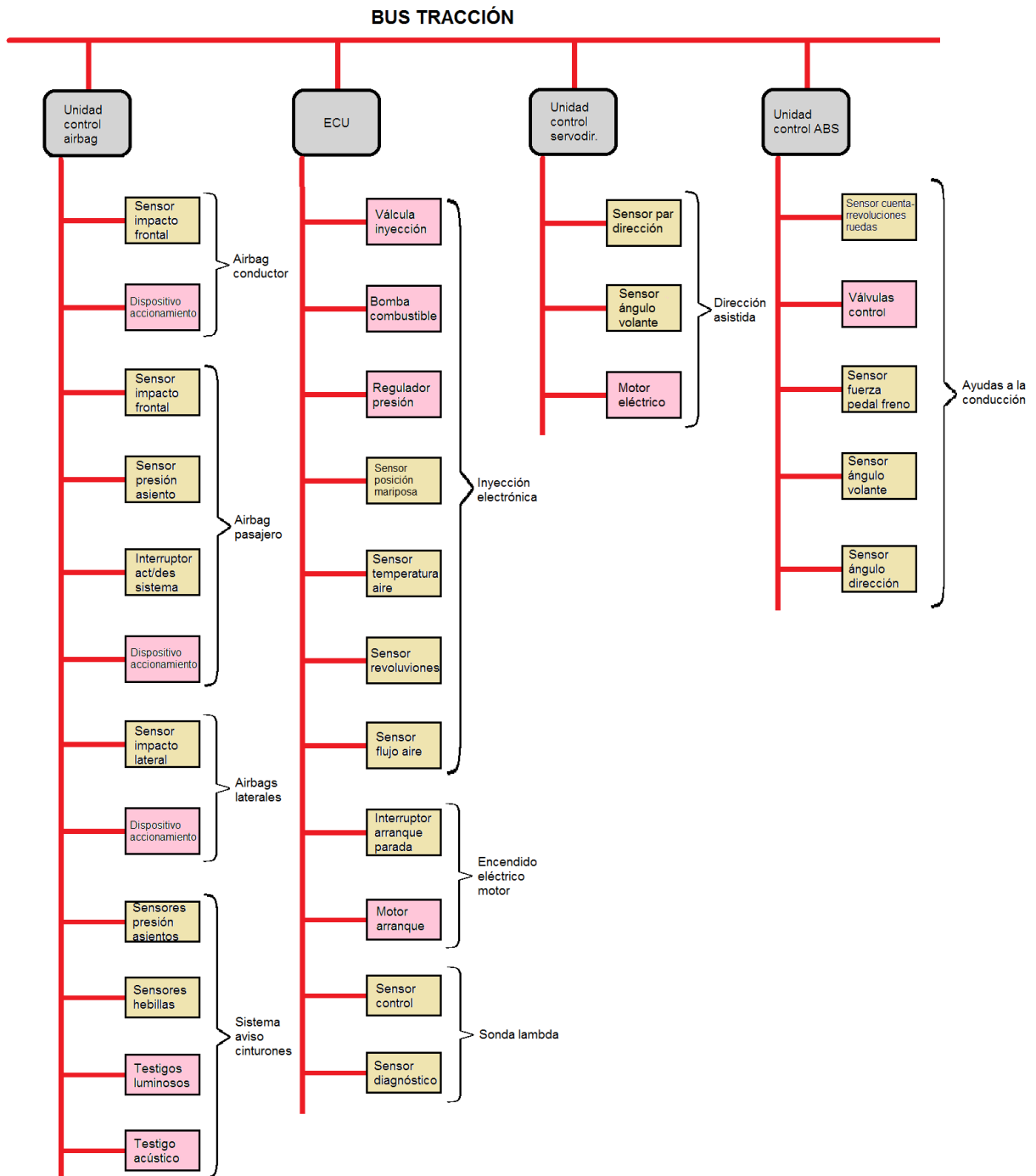

**Figura 11:** Esquema del bus de tracción

**Tabla 5: Arquitectura Bus de Tracción**

BUS TRACCIÓN			
Dispositivo	Tipo	Número Nodos	Sistema
Unidad control airbag	Centralita	19	
Sensor impacto frontal	Sensor	1	Airbag conductor
Dispositivo accionamiento	Actuador	1	Airbag conductor
Sensor impacto frontal	Sensor	1	Airbag pasajero
Sensor presión asiento	Sensor	1	Airbag pasajero
Interruptor act/desact airbag	Mando/Interruptor	1	Airbag pasajero
Dispositivo accionamiento	Actuador	1	Airbag pasajero
Sensor impacto lateral	Sensor	2	Airbags laterales
Dispositivo accionamiento	Actuador	2	Airbags laterales
Sensor presión asientos	Sensor	4	Aviso cinturones
Sensores hebillas	Sensor	5	Aviso cinturones
Testigo luminoso salpicadero	Actuador	1	Aviso cinturones
Testigo acústico	Actuador	1	Aviso cinturones
Unidad control motor (ECU)	Centralita	12	
Sensor T <sup>a</sup> aire entrada	Sensor	1	Inyección Monopunto elec.
Sensor revoluciones	Sensor	1	Inyección Monopunto elec.
Sensor flujo aire MAF	Sensor	1	Inyección Monopunto elec.
Sensor posición de la mariposa	Sensor	1	Inyección Monopunto elec.
Bomba combustible	Actuador	1	Inyección Monopunto elec.
Válvula inyección	Actuador	1	Inyección Monopunto elec.
Regulador presión	Actuador	1	Inyección Monopunto elec.
Interruptor arranque/parada	Mando/Interruptor	1	Encendido eléctrico motor
Motor arranque	Actuador	1	Encendido eléctrico motor
Sensor control (antes tratamiento)	Sensor	1	Sonda lambda
Sensor diagnóstico (después tratamiento)	Sensor	1	Sonda lambda
Unidad control servodirección	Centralita	3	
Sensor par dirección	Sensor	1	Dirección asistida
Sensor ángulo volante	Sensor	1	Dirección asistida
Motor eléctrico	Actuador	1	Dirección asistida
Unidad control ayudas conducción	Centralita	8	
Sensores contarrevoluciones ruedas	Sensor	4	ABS Antibloqueo ruedas
Bomba/Válvulas sistema hidráulico	Actuador	1	ABS Antibloqueo ruedas

Sensores contarrevoluciones ruedas	Sensor	4	BAS Freno emergencia
Sensor fuerza pedal freno	Sensor	1	BAS Freno emergencia
Válvulas sistema hidráulico	Actuador	4	BAS Freno emergencia
Sensores contarrevoluciones ruedas	Sensor	4	ASR Control tracción
Válvulas sistema hidráulico	Actuador	4	ASR Control tracción
Sensores contarrevoluciones ruedas	Sensor	4	ESP Control estabilidad
Sensor ángulo dirección volante	Sensor	1	ESP Control estabilidad
Sensor aceleración transversal	Sensor	1	ESP Control estabilidad
Válvulas sistema hidráulico	Actuador	4	ESP Control estabilidad

## 5.5 Arquitectura del bus panel mando volante

Este bus conecta directamente la unidad de control del mando del volante a la Gateway principal del sistema, en esta unidad de control se recogen todos los datos proporcionados por los diferentes sensores como el cuentakilómetros, la velocidad del automóvil etc... Y también hay algunos testigos que indican los sistemas que han sido activados por los distintos mandos e interruptores del vehículo por el conductor. La velocidad en este bus será de 250 Kbyte/s, ya que es la que marca el SAE J1939.

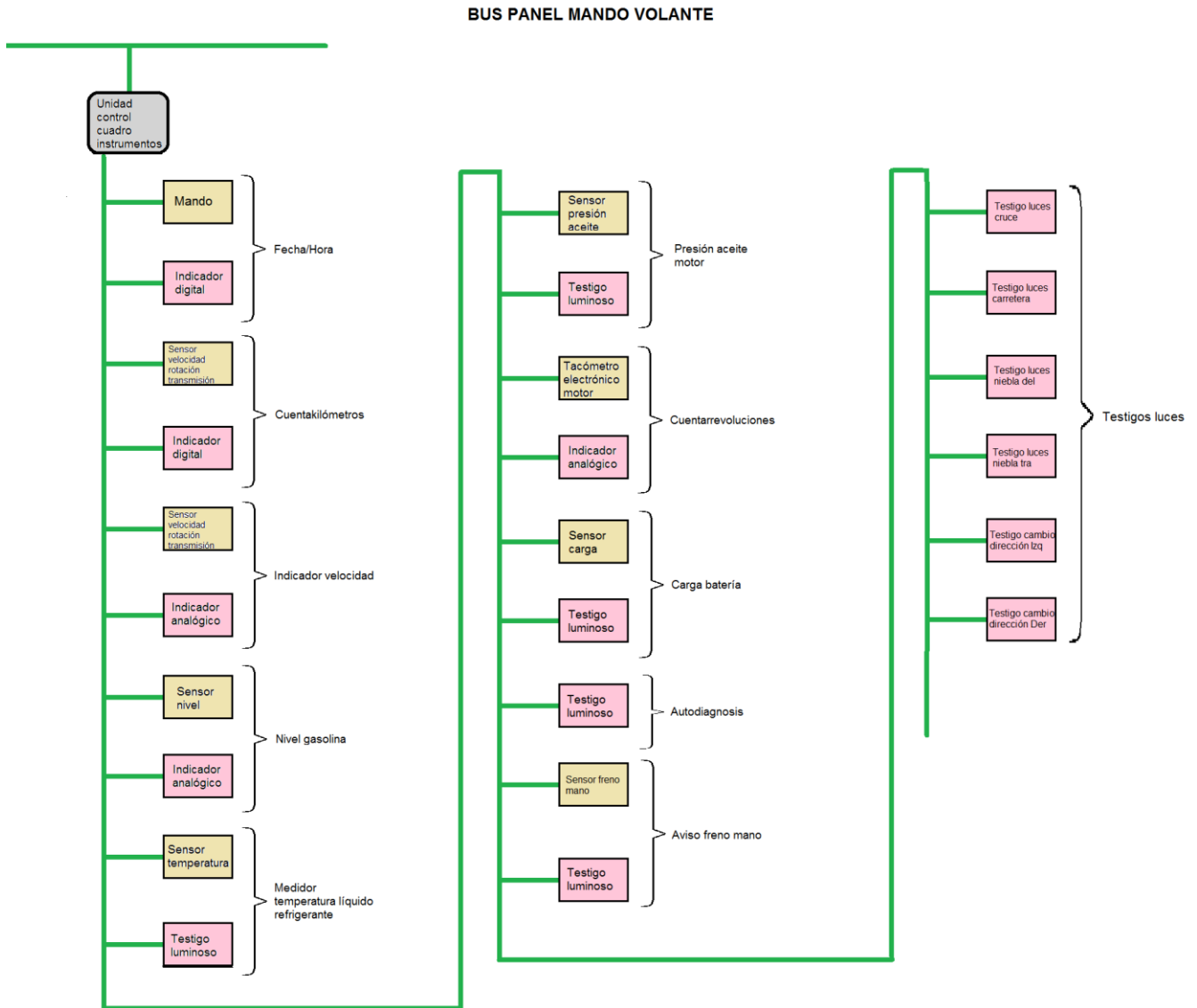

**Figura 12:** Esquema del Bus panel de mando del volante

**Tabla 6:** Arquitectura Bus Panel de mando

BUS PANEL MANDO VOLANTE			
Dispositivo	Tipo	Número Nodos	Sistema
Unidad control cuadro instrumentos	Centralita	25	
Mando Fecha/Hora	Mando/Interruptor	1	Fecha/Hora
Indicador digital	Actuador	1	Fecha/Hora
Sensor rotación transmisión	Sensor	1	Cuentakilómetros
Indicador digital	Actuador	1	Cuentakilómetros
Sensor rotación transmisión	Sensor	1	Indicador velocidad
Indicador analógico	Actuador	1	Indicador velocidad
Tacómetro electrónico motor	Sensor	1	Cuentarrevoluciones
Indicador analógico	Actuador	1	Cuentarrevoluciones
Sensor nivel gasolina	Sensor	1	Nivel gasolina
Indicador analógico	Actuador	1	Nivel gasolina
Sensor T <sup>a</sup> refrigerante motor	Sensor	1	Medidor T <sup>a</sup> líquido refr.
Testigo luminoso	Actuador	1	Medidor T <sup>a</sup> líquido refr.
Sensor presión aceite	Sensor	1	Presión aceite motor
Testigo luminoso	Actuador	1	Presión aceite motor
Sensor carga	Sensor	1	Carga batería
Testigo luminoso	Actuador	1	Carga batería
Testigo luminoso	Actuador	1	Autodiagnos
Sensor freno mano	Sensor	1	Aviso freno mano
Testigo luminoso	Actuador	1	Aviso freno mano
Testigo luces cruce	Actuador	1	Testigos luces
Testigo luces carretera	Actuador	1	Testigos luces
Testigo luces niebla delanteras	Actuador	1	Testigos luces
Testigo luces niebla traseras	Actuador	1	Testigos luces
Testigo indicador cambio dirección izquierda	Actuador	1	Testigos luces
Testigo indicador cambio dirección derecha	Actuador	1	Testigos luces

## 6. Centralitas, sensores, mandos/Interruptores y actuadores a implementar en el vehículo.

A continuación, se ha realizado una lista con los diferentes elementos que forman todo el sistema de comunicaciones del vehículo, desde las centralitas y unidades de control hasta el último sensor y actuador de cada sistema. La elección de cada uno de estos elementos se ha hecho teniendo en cuenta que los vehículos para los que trabajan en el mercado usan el bus CAN como sistema de comunicación, ya que cada elemento por sí solo no especifica con que sistema de comunicaciones puede o no trabajar. En muchas ocasiones su única referencia técnica es el tipo de modelos con los que puede ser usado. También se han tenido en cuenta las dimensiones y características del vehículo en estudio, ya que muchos de estos dispositivos varían según el tamaño del coche o su tipo de motor o dirección asistida, escogiendo los que van equipados en automóviles con los mismos sistemas que queremos comunicar en el vehículo.

En algunos dispositivos se ha optado por dejar los que el vehículo poseía de serie, debido a varias razones, que no se ha encontrado el dispositivo deseado que trabajara con Bus CAN, o bien porque su sustitución requeriría de un problema de diseño nuevo en el vehículo o en algunos de sus mandos, lo cual no es objeto de este proyecto. Obviamente estos dispositivos no pueden ser conectados directamente al bus de comunicaciones, ya que sus señales siguen protocolos diferentes. Para solucionar este problema cada dispositivo que no haya sido creado específicamente para CAN se le deberá añadir a la salida de su señal una unidad de control de la señal compuesta por un microcontrolador que posea un controlador de CAN así como un transceptor siguiendo el siguiente esquema (Figura 13).

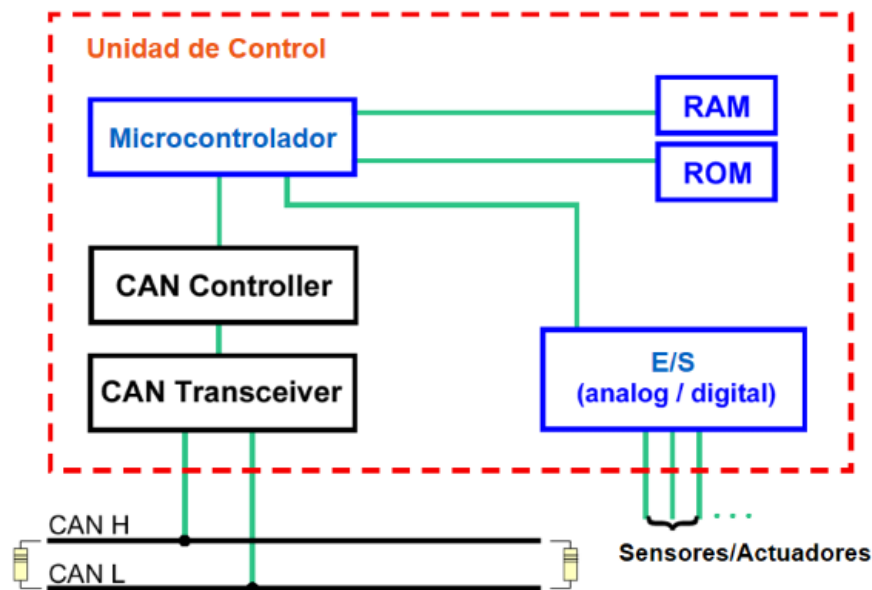



**Figura 13:** Estructura unidad control señales

Esta unidad de control debería ser programada, conociendo el tipo de señales que los mandos y sensores de serie emiten así como los que el protocolo del Bus CAN exige. Por supuesto, todos los demás dispositivos que han sido sustituidos no necesitan esta unidad de control al estar fabricados para modelos que usan CAN en sus comunicaciones por lo que no habrá que adecuar las señales de entrada y salida.

Los elementos básicos del sistema de comunicaciones, (Tabla 7) son los mostrados a continuación. Tipo de controlador y transceptor que serán usados en el vehículo así como el propio cable del sistema:

**Tabla 7:** Otros elementos del sistema

Descripción	Marca	Nº referencia	Imagen
Cable Bus CAN 2X2X0.34 MM2.	Cervi	35100045	
Controlador CAN 2.0B, 18 pines	Microchip	MCP2515-I/SO	
Transceptor CAN 2.0B, 8 pines	Microchip	MCP2551-I/SN	

- El diagrama de bloques del controlador MCP2515-I/SO (Figura 14) es:

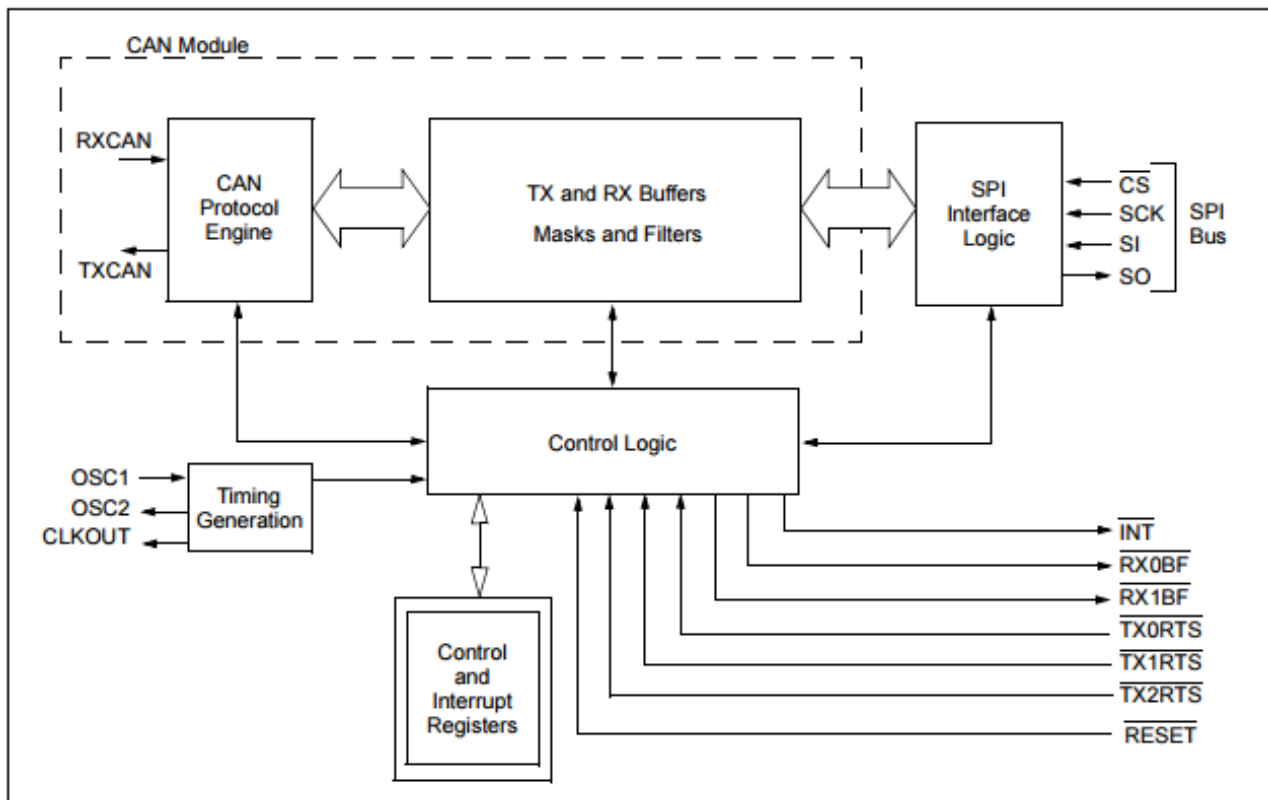

**Figura 14:** Diagrama bloques controlador MCP2515-I/SO

- A continuación, (Tabla 8) se adjunta una tabla con la descripción de los 18 pines del controlador:

**Tabla 8:** Descripción PINs salida Controlador MCP2515-I/SO

Nombre	PDIP/SO IC Pin #	TSSOP Pin #	I/O/P Tipo	Descripción	Función Alternativa
TXCAN	1	1	O	Transmite pin de salida del bus CAN	---
RXCAN	2	2	I	Recibe pin de entrada del bus CAN	---
CLKOUT	3	3	O	Pin de salida de reloj programable	Comienzo de la señal de trama
TX0RTS	4	4	I	Transmite búfer TB0 solicita-envía. 100 kΩ pull-up interno hasta V <sub>DD</sub>	Propósito general de entrada digital.
TX1RTS	5	5	I	Transmite búfer TB1 solicita-envía. 100 kΩ pull-up interno hasta V <sub>DD</sub>	Propósito general de entrada digital.
TX2RTS	6	7	I	Transmite búfer TB2 solicita-envía. 100 kΩ pull-up interno hasta V <sub>DD</sub>	Propósito general de entrada digital.
OSC2	7	8	O	Salida del oscilador	---
OSC1	8	9	I	Entrada del oscilador	Entrada del reloj externo
V <sub>SS</sub>	9	10	P	Tierra	---
RX1BF	10	11	O	Recibe búfer pin de interrupción o RXB1 salida digital de propósito general	Salida digital de propósito general
RX0BF	11	12	O	Recibe búfer pin de interrupción o RXB0 salida digital de propósito general	Salida digital de propósito general
INT	12	13	O	Pin de salida de interrupción	---
SCK	13	14	I	Pin de entrada de reloj para la interfaz de SPI	---
SI	14	16	I	Pin de entrada de datos para la interfaz de SPI	---
SO	15	17	O	Pin de salida de datos para la interfaz de SPI	---
CS	16	18	I	Chip de selección de entrada para la interfaz de SPI	---
RESET	17	19	I	Entrada de reposición bajo Dispositivo activo	---
V <sub>DD</sub>	18	20	P	Alimentación positiva para la lógica y los pines de E / S	---
NC	---	6,15	---	Sin conexión interna	---

**Nota:** Identificación de cada tipo: I = Input; O = Output; P = Power



- El diagrama de bloques del transceptor (Figura 15) es:

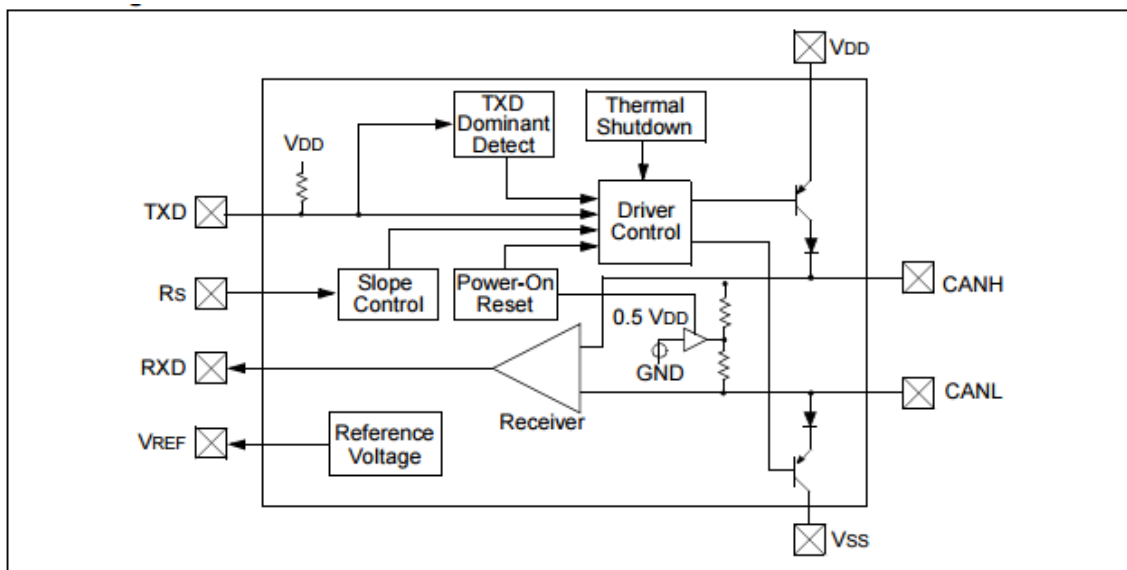

**Figura 15:** Diagrama bloques transceptor MCP2551-I/SN

- A continuación, (Tabla 9) se adjunta una tabla con la descripción de los 8 pines del transceptor:

**Tabla 9:** Descripción PINs salida Transceptor MCP2551-I/SN



Número	Nombre	Función
1	TXD	Transmitir datos entrada
2	V <sub>SS</sub>	Tierra
3	V <sub>DD</sub>	Tensión de alimentación
4	RXD	Recibidor datos salida
5	V <sub>REF</sub>	Tensión de referencia
6	CANL	CAN nivel tensión bajo
7	CANH	CAN nivel tensión alto
8	R <sub>S</sub>	Control pendiente entrada

## 6.1 Centralitas y unidades de control.

En la tabla 10 se pueden ver las diferentes centralitas que manejan las comunicaciones en el vehículo, todas son de carácter nuevo excepto la unidad de control del cuadro de instrumentos, ya que como es difícil cambiar todo el cuadro sin una ingeniería de diseño nueva, se ha optado por mantener todo el cuadro y por tanto también su unidad de control.

**Tabla 10: Centralitas del sistema**







<b>Centralitas</b>			
Centralita	Marca	Nº referencia	Imagen
Interfaz para bus de datos (Gateway) / Centralita general	VW	1K0 907 530 S	
Unidad control radio/GPS	VW	RNS 510	
Unidad control asistencia aparcamiento	VW	8Z0 919 283 A	
Unidad control aviso cambio carril	VW	410 907 568 A	
Unidad control puerta conductor	Bosch	1K0 959 793 M	
Unidad control puerta pasajero	Bosch	1K0 959 793 M	
Unidad control climatic	VW	5K0 907 044 GR	
Unidad control columna dirección	VW	1K0 953 549 A	
Unidad control confort	Hella	1K0 959 433 BT	
Unidad control airbag	VW	6Q0 909 601	
Unidad control motor (ECU)	Bosch	0 261 201 667	

















Unidad control servodirección	VW	J500	
Unidad control ABS	VW	1C0 907 379 J	
Unidad control cuadro instrumentos	De serie		

## 6.2 Sensores mandos/Interruptores y actuadores.

Aquí, (Tabla 11) se recogen todos los diferentes elementos de cada uno de los sistemas a implementar, sustituir o que ya posee el propio vehículo, estos han sido ordenados según el sistema o sistemas a los que pertenecen. En la tabla se puede ver el número de elementos que se necesitarán así como el fabricante, su número de referencia y una pequeña imagen del elemento. Todos los interruptores que poseía el vehículo de serie o traía como extra no han sido sustituidos.









**Tabla 11:** Dispositivos del sistema













Sensores, actuadores y mandos/Interruptores a implementar en el vehículo					
Sistema	Descripción dispositivo	Número dispositivos	Marca	Nº referencia	Imagen
Radio / Lector CD-DVD	Botones radio	1	VW	RNS 510	
	Antena	1	De serie		
	Lector CD	1	VW	RNS 510	
	Altavoces	2	De serie		
	Pantalla digital	1	VW	RNS 510	
Navegador GPS	Pantalla digital	1	VW	RNS 510	
	Botones GPS	1	VW	RNS 510	

	Receptor GPS	1	VW	RNS 510	
	Altavoces	2	De serie		
Termómetro exterior/interior	Pantalla digital	1	Vemo	V10 72 1114	
	Termómetro interior	1	Vemo	V10 72 1204	
	Testigo luminoso (Pantalla digital)	1	VW	RNS 510	
Asistencia aparcamiento	Sensores proximidad objetos	8	Vemo	1S0 919 275	
	Testigo salpicadero (Pantalla radio/GPS)	1	VW	RNS 510	
Aviso cambio carril	Sensores infrarrojos	4	Honeywell	SPX1189 002	
	Testigo salpicadero (Pantalla radio/GPS)	1	VW	RNS 510	
Sensor cierre puertas	Sensor/Cerradura cierre puerta	2	Baytter	3B1 837 016 A	
	Testigo luminoso salpicadero	2	VW	RNS 510	
Retrovisores eléctricos	Mando 4 direcciones	2	De serie		
	Motor 4 direcciones	2	VW	4M0 486 020	
Asiento eléctrico	Interruptores regulación asientos	2	Vemo	V10 73 0167	
	Motores asiento y ángulo adelante/atrás	2	Bosch	0 390 203 002	
Elevalunas eléctricos	Interruptor subida/bajada	2	De serie		

















	Motor elevavolante	2	Vemo	6Q2 959 802 A	
Sistema climatización	Sensor de alta presión	1	NRF	38935	
	Sensor temperatura salida evaporador	1	Vemo	V10 72 1204	
	Sensor temperatura agente frigorífico	1	FAE	33784	
	Mandos sistema climatización	1	VW	5K0 907 044 GR	
	Motor ventilador	1	Thermotec	DDS003TT	
	Válvula reguladora compresor	1	Frigair	431 30130	
	Testigo luminoso temperatura	1	VW	5K0 907 044 GR	
Asientos térmicos	Interruptor asientos térmicos	2	VW	5K0 907 044 GR	
	Resistencias asientos térmicos	2	Vemo	5K0 959 772	
Limpiaparabrisas	Mando volante limpiaparabrisas	1	De serie		
	Sensor lluvia	1	Vemo	1K0 955 559	
	Motor limpiaparabrisas delantero	1	Vemo	6Q1 955 119 A	
	Motor limpiaparabrisas trasero	1	Metzger	2190515	



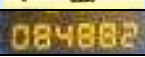











Claxon	Interruptor claxon	1	De serie		
	Bocina	1	Vemo	6Q0 951 221 H	
Luces	Mando volante luces	1	De serie		
	Sensor cantidad luz	1	TianGao	BDL-ALS1	
	Interruptor marcha atrás	1	Quinton Hazell	XRLS123	
	Interruptor luces freno	1	Febi Bilstein	32866	
	Bombillas y leds	19	De serie		
Cierre centralizado	Receptor señal mando y bomba	1	VW	6N0 962 257 A	
	Motores cerradura puertas	3	VDO	X10 729 002 009	
Techo solar	Interruptor abrir/cerrar techo	1	VW	1KD 959 613	
	Motor abrir cerrar/techo	1	VW	4B0 959 591	
Luna térmica trasera	Interruptor activar/desactivar luna	1	De serie		
	Relé luna térmica	1	De serie		
	Testigo luna térmica	1	De serie		

Control luces encendidas	Testigo acústico	1	De serie		---
Señal emergencia	Interruptor	1	De serie		
	Luces intermitentes	4	De serie		
	Testigo luminoso	1	De serie		
Luz interior vehículo	Interruptor luz interior	1	De serie		
	Luz interior	1	De serie		
Sistema airbags	Sensor impacto frontal	1	Bosch	0 273 101 021	
	Sensor impacto lateral	1	Bosch	0 273 101 021	
	Sensor presión asiento pasajero	1	Bosch	0 261 230 081	
	Interruptor activar /desactivar airbag	1	De serie		
	Testigo luminoso airbag pasajero	1	De serie		
	Dispositivo accionamiento airbag	4	De serie		
Sistema aviso cinturones	Sensor presión asientos pasajeros	4	Bosch	0 261 230 081	
	Sensor hebillas	5	VW	1J3 858 471 L	
	Testigo luminoso salpicadero	1	VW	RNS 510	
	Testigo acústico	1	VW	RNS 510	---
Sistema inyección electrónica	Válvula inyección	1	Bosch	0 280 156 173	

	Bomba combustible	1	Bosch	0 986 580 824	
	Sensor posición mariposa	1	Bosch	0 280 120 334	
	Regulador presión	1	Bosch	0 281 002 399	
	Sensor temperatura aire	1	Vemo	06B 905 379 A	
	Sensores revoluciones	1	FAE	79177	
	Sensor flujo aire MAF	1	Johns	LMM 95 49-079	
Encendido eléctrico motor	Interruptor arranque/parada	1	De serie		
	Motor arranque	1	Bosch	0 986 020 290	
Sonda lambda	Sensor control	1	Vemo	V10 76 0090	
	Sensor diagnóstico	1	Vemo	V10 76 0071	
Dirección asistida	Sensor par dirección	1	Baldoms	SEI-SEN06	
	Sensor ángulo volante	1	Vemo	1K0 959 654	
	Motor/Bomba eléctrica	1	VW	6N0 422 155 E	
Ayudas a la conducción ABS, BAS, ASR, ESP	Sensor cuentarrevoluciones rueda delantera derecha	1	Metzger	0900075	

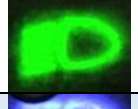

	Sensor cuentarrevoluciones rueda delantera izquierda	1	Metzger	0900074	
	Sensor cuentarrevoluciones rueda trasera derecha	1	Metzger	0900055	
	Sensor cuentarrevoluciones rueda trasera izquierda	1	Metzger	0900055	
	Bomba/Válvulas control líquido frenos	1	VW	1J0 614 117 F	
	Sensor fuerza pedal freno	1	Vemo	013 542 77 17	
	Sensor ángulo dirección volante	1	Vemo	1K0 959 654	
	Sensor aceleración transversal	1	Bosch	0 265 005 624	
Fecha/Hora	Mando ajuste hora	1	De serie		
	Indicador digital	1	De serie		
Cuentakilómetros	Sensor velocidad rotación transmisión	1	Vemo	V10 72 0929 1	
	Indicador digital	1	De serie		
Indicador velocidad	Sensor velocidad rotación transmisión	1	Vemo	V10 72 0929 1	
	Indicador analógico	1	De serie		
Cuentarrevoluciones motor	Tacómetro electrónico motor	1	FAE	79177	
	Indicador analógico	1	De serie		
Nivel gasolina	Sensor nivel	1	Airtex	E10730M	

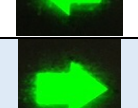
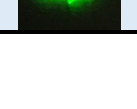
	Indicador analógico	1	De serie		
Medidor temperatura líquido refrigerante	Sensor temperatura	1	FAE	33784	
	Testigo luminoso	1	De serie		
Presión aceite motor	Sensor presión aceite	1	FAE	12881	
	Testigo luminoso	1	De serie		
Carga batería	Sensor carga	1	De serie		
	Testigo luminoso	1	De serie		
Autodiagnosis	Testigo luminoso	1	De serie		
Aviso freno mano	Sensor freno mano	1	De serie		
	Testigo luminoso	1	De serie		
Testigos luces	Testigo luces cruce	1	De serie		
	Testigo luces carretera	1	De serie		
	Testigo luces niebla delanteras	1	De serie		
	Testigo luces niebla traseras	1	De serie		
	Testigo indicador cambio dirección izquierda	1	De serie		
	Testigo indicador cambio dirección derecha	1	De serie		

**Notas:**

- Todos los testigos luminosos que no poseía el vehículo (Aviso cinturones, asistencia aparcamiento, cambio involuntario de carril...) han sido integrados en la pantalla digital de la unidad de control de la Radio/Navegador GPS *VW RNS 510*.
- El sensor de temperatura de la salida del evaporador y la temperatura interior son el mismo.
- El sensor utilizado para el cuentakilómetros y el indicador de velocidad son el mismo.
- El sensor de presión del asiento del copiloto sirve tanto para el control de cinturones como para la activación del airbag.

## 7. Situación de los distintos buses y sistemas en el vehículo

En este apartado se ha realizado la implementación de los sistemas descritos anteriormente en la propia arquitectura del vehículo. Este estudio se ha hecho de una forma aproximada, ya que no hay disponibles los diferentes planos de detalle del vehículo que podría poseer el propio fabricante del vehículo, aun así se ha intentado ser lo más realista y conciso posible teniendo en cuenta la arquitectura del vehículo, así como el lugar donde deben ir los distintos elementos de los sistemas. Por último, se ha calculado de forma aproximada la longitud de cableado aproximada necesaria, así como el número de conexiones al bus, controladores y transceptores de bus CAN. En total se van a necesitar:

- Longitud total de cable necesaria (Metros): 94,1
- Número total de puntos de conexión al bus necesarios: 142
- Número total de transceptores y controladores necesarios: 47

### 7.1 Bus infotenimiento

#### 7.1.1 Esquema general de las centralitas

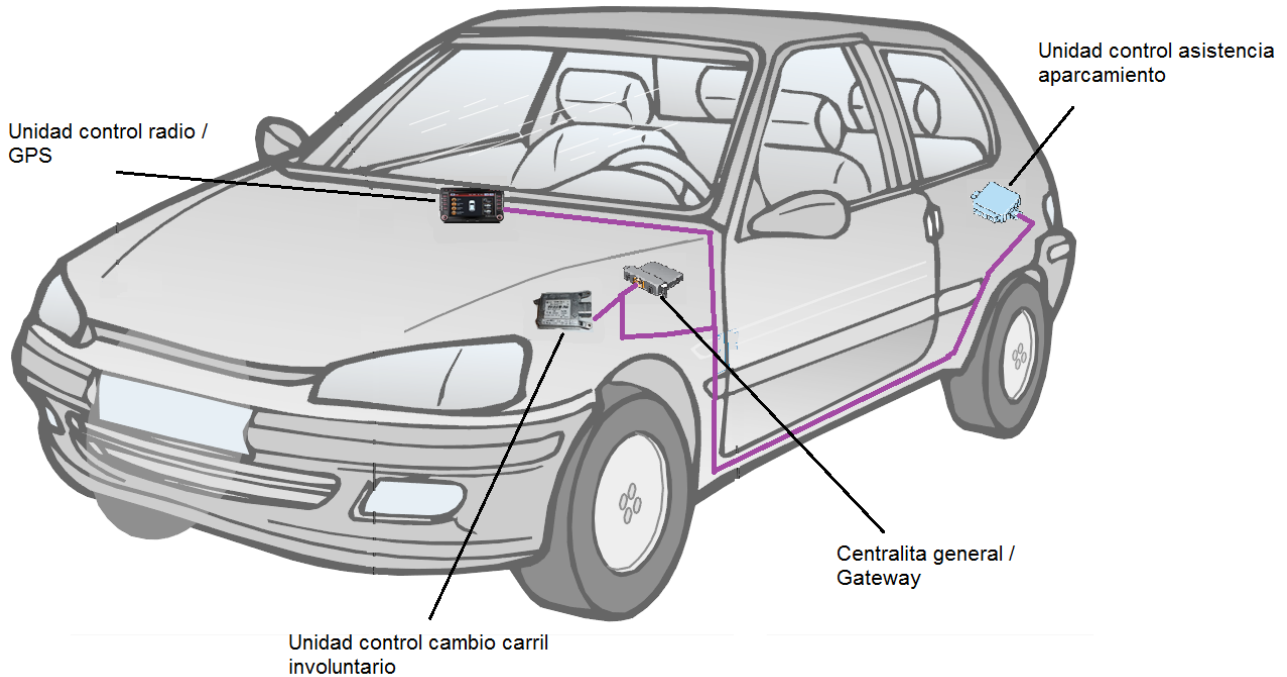

**Figura 16:** Esquema bus infotenimiento

- Longitud de cable necesaria (Metros): 4
- Número de puntos de conexión al bus necesarios: 3
- Número de transceptores y controladores necesarios: 0

7.1.2 Esquema Bus Radio / GPS



**Figura 17:** Esquema bus Radio/GPS 1

Fuente: <http://www.dx.com>

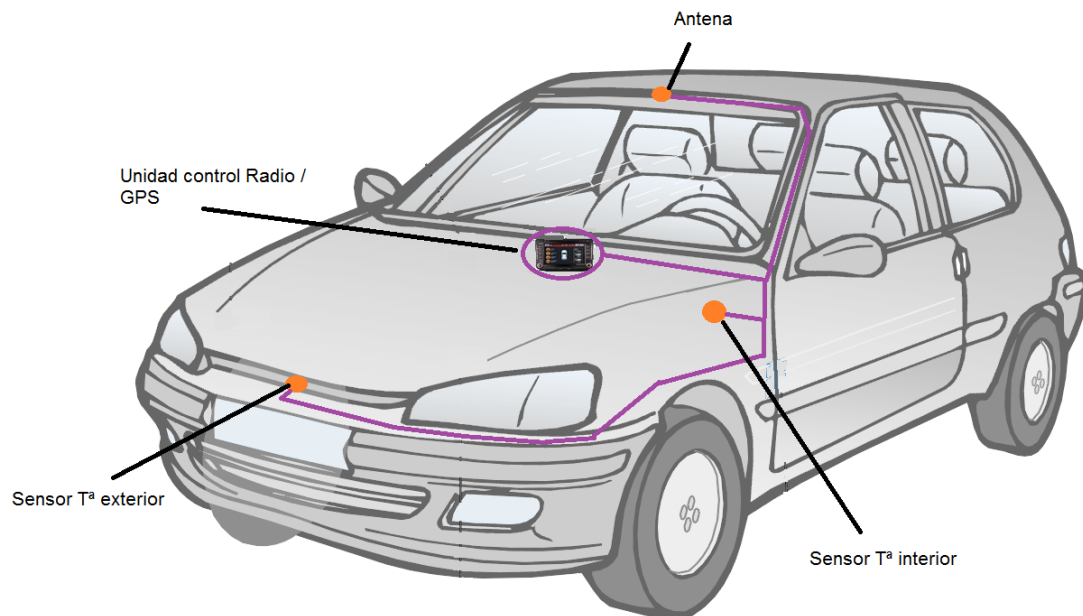

**Figura 18:** Esquema bus Radio/GPS 2

- Longitud de cable necesaria (Metros): 4,2
- Número de puntos de conexión al bus necesarios: 3
- Número de transceptores y controladores necesarios: 1

7.1.3 Esquema Bus asistencia aparcamiento

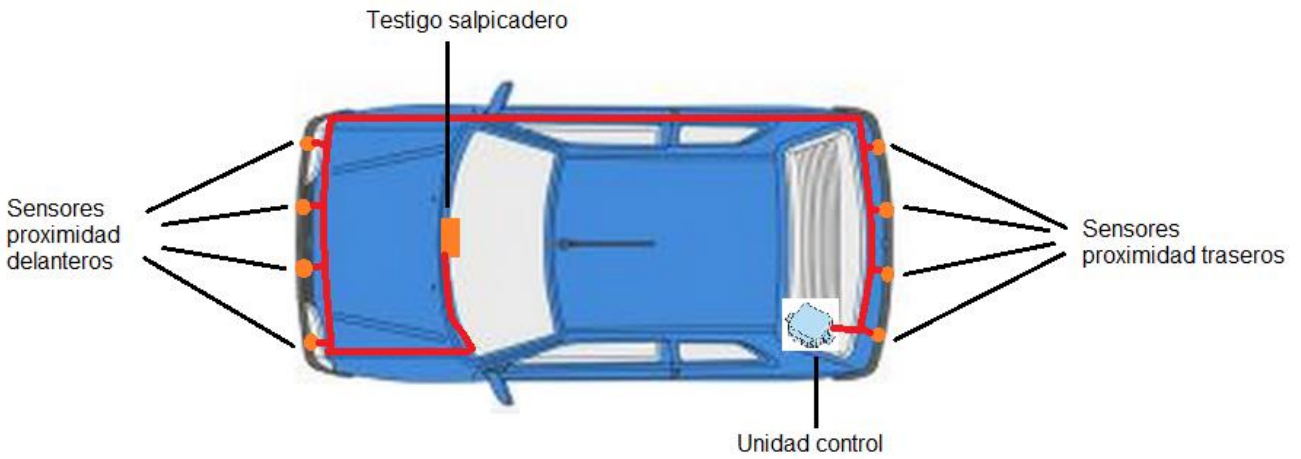

**Figura 19:** Esquema bus asistencia aparcamiento

- Longitud de cable necesaria (Metros): 8,5
- Número de puntos de conexión al bus necesarios: 9
- Número de transceptores y controladores necesarios: 0

7.1.4 Esquema Bus cambio carril

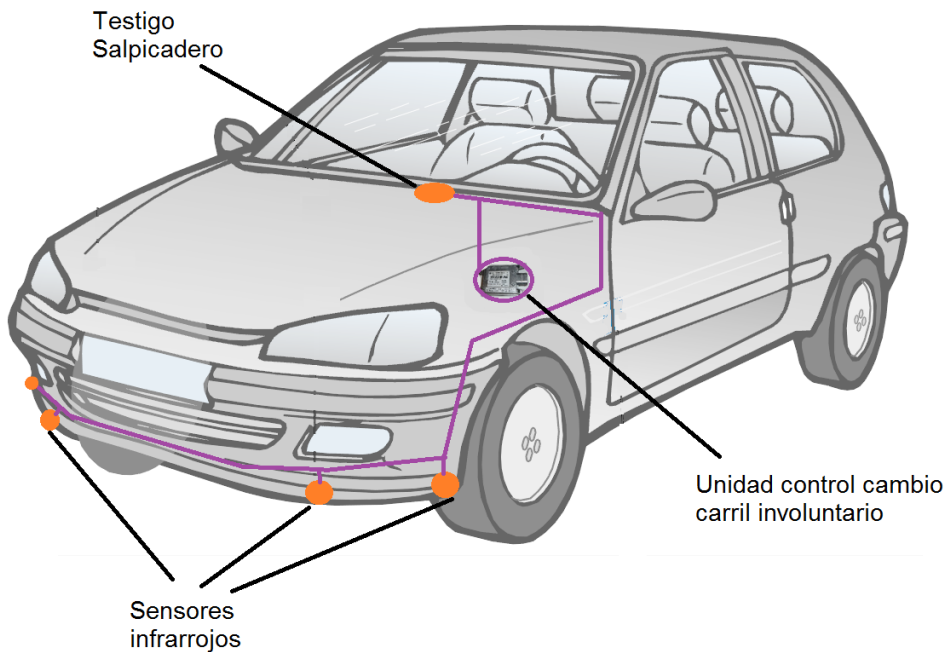

**Figura 20:** Esquema bus cambio carril

- Longitud de cable necesaria (Metros): 3,8
- Número de puntos de conexión al bus necesarios: 5
- Número de transceptores y controladores necesarios: 4

## 7.2 Bus confort

### 7.2.1 Esquema general de las centralitas

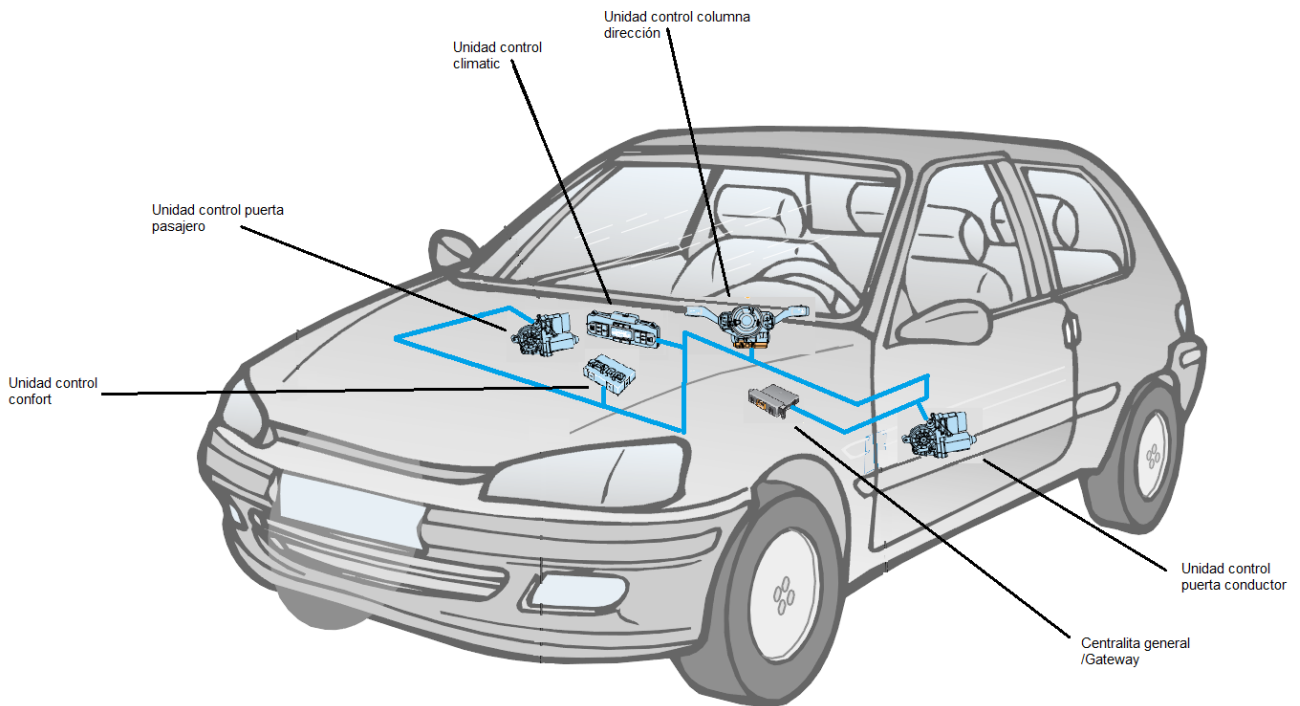

**Figura 21:** Esquema bus puerta conductor

- Longitud de cable necesaria (Metros): 3,6
- Número de puntos de conexión al bus necesarios: 5
- Número de transceptores y controladores necesarios: 0

### 7.2.2 Esquema Bus puerta conductor

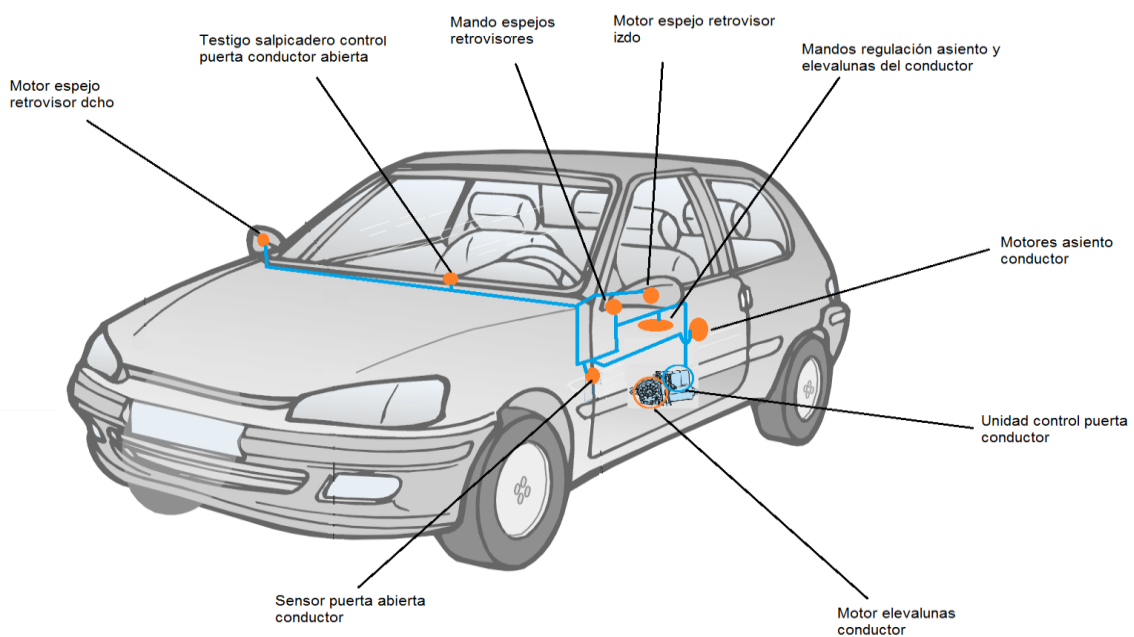

**Figura 22:** Esquema bus puerta conductor

- Longitud de cable necesaria (Metros): 4,5
- Número de puntos de conexión al bus necesarios: 7
- Número de transceptores y controladores necesarios: 1

### 7.2.3 Esquema Bus puerta pasajero

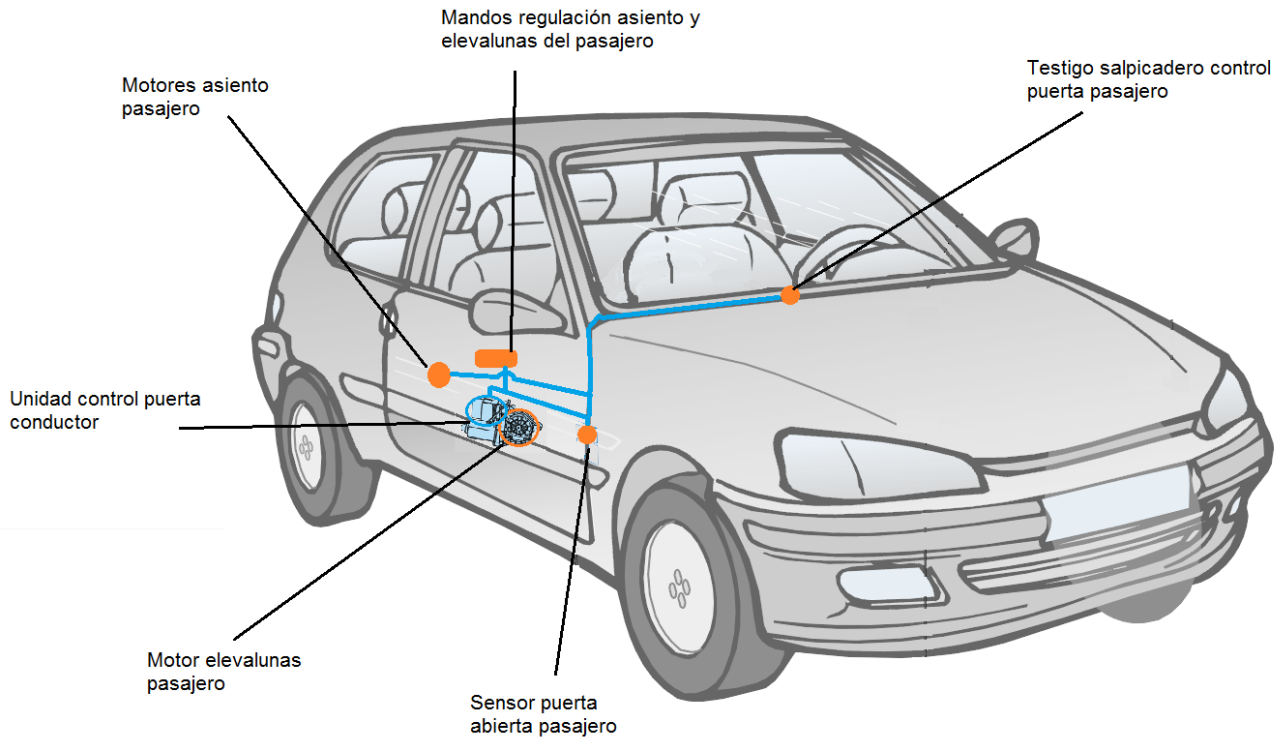

**Figura 23:** Esquema bus puerta pasajero

- Longitud de cable necesaria (Metros): 3,2
- Número de puntos de conexión al bus necesarios: 4
- Número de transceptores y controladores necesarios: 1



## 7.2.4 Esquema Bus control climatización

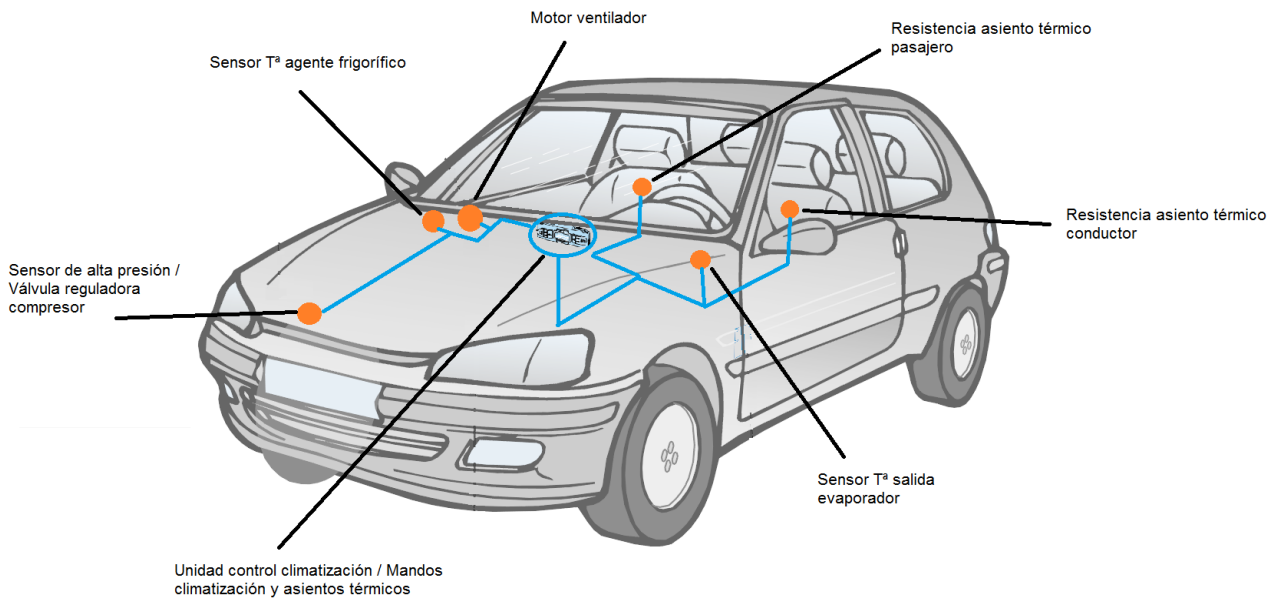

**Figura 24: Esquema bus infotenimiento**

- Longitud de cable necesaria (Metros): 4,8
- Número de puntos de conexión al bus necesarios: 8
- Número de transceptores y controladores necesarios: 0

## 7.2.5 Esquema Bus columna dirección

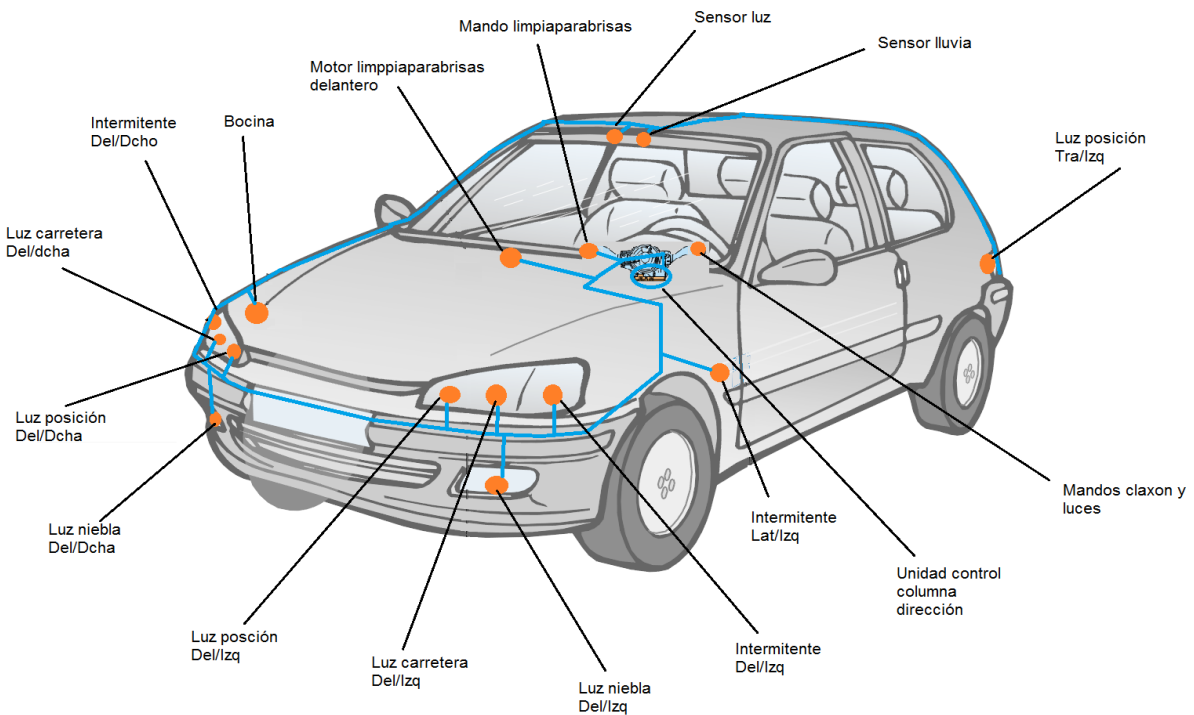

**Figura 25: Esquema bus columna dirección 1**

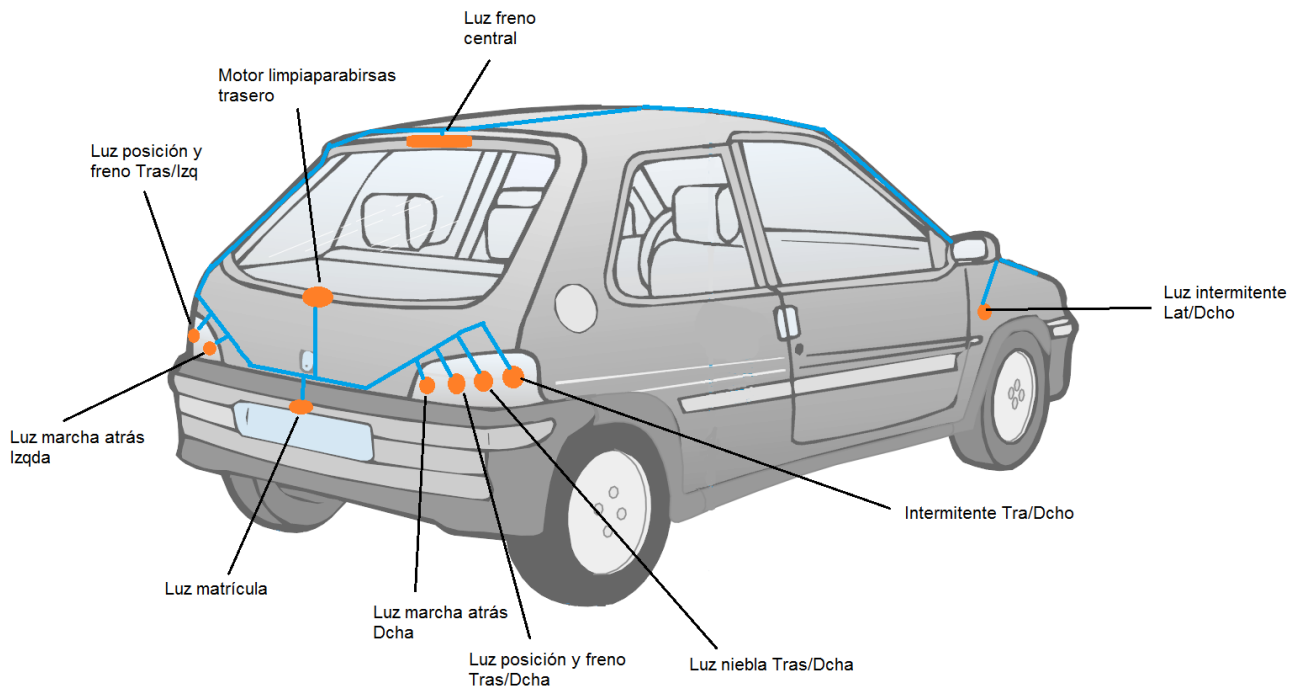

**Figura 26: Esquema bus columna dirección 2**

- Longitud de cable necesaria (Metros): 9,9
- Número de puntos de conexión al bus necesarios: 27
- Número de transceptores y controladores necesarios: 22

### 7.2.6 Esquema Bus centralita confort

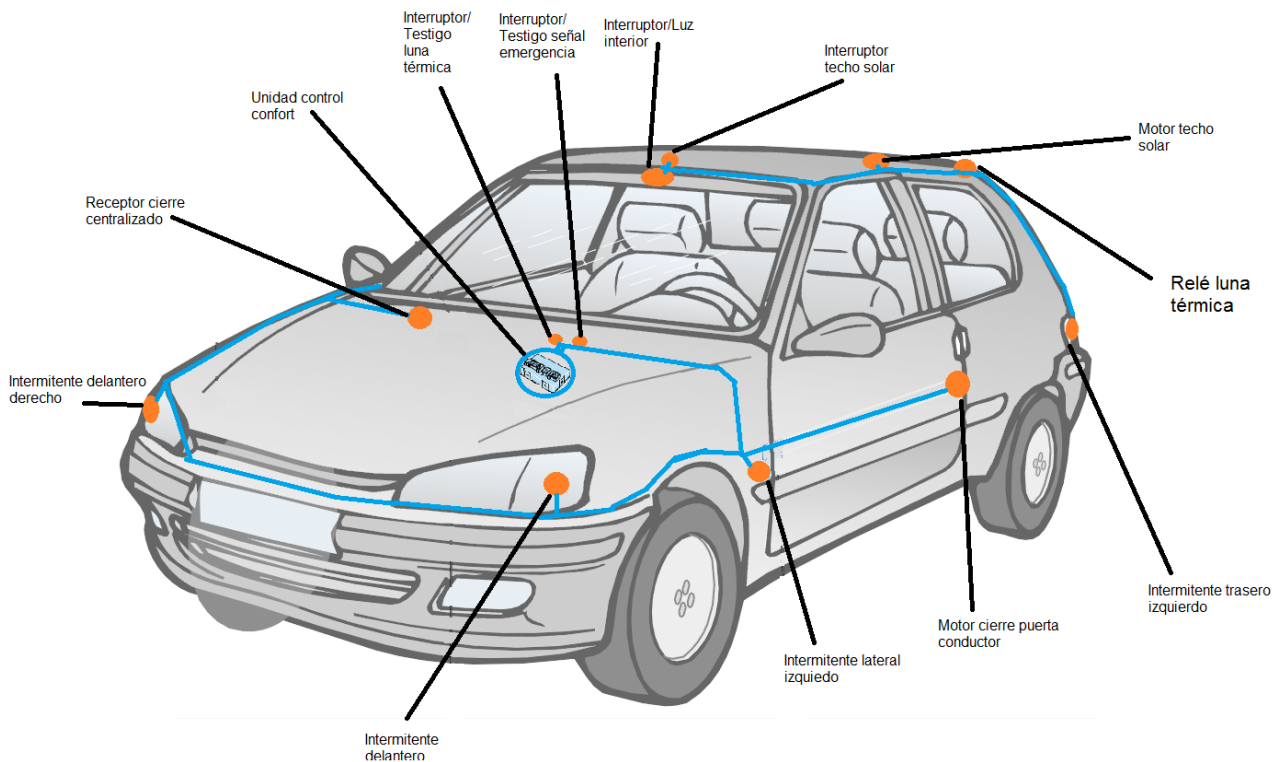

**Figura 27: Esquema bus confort 1**

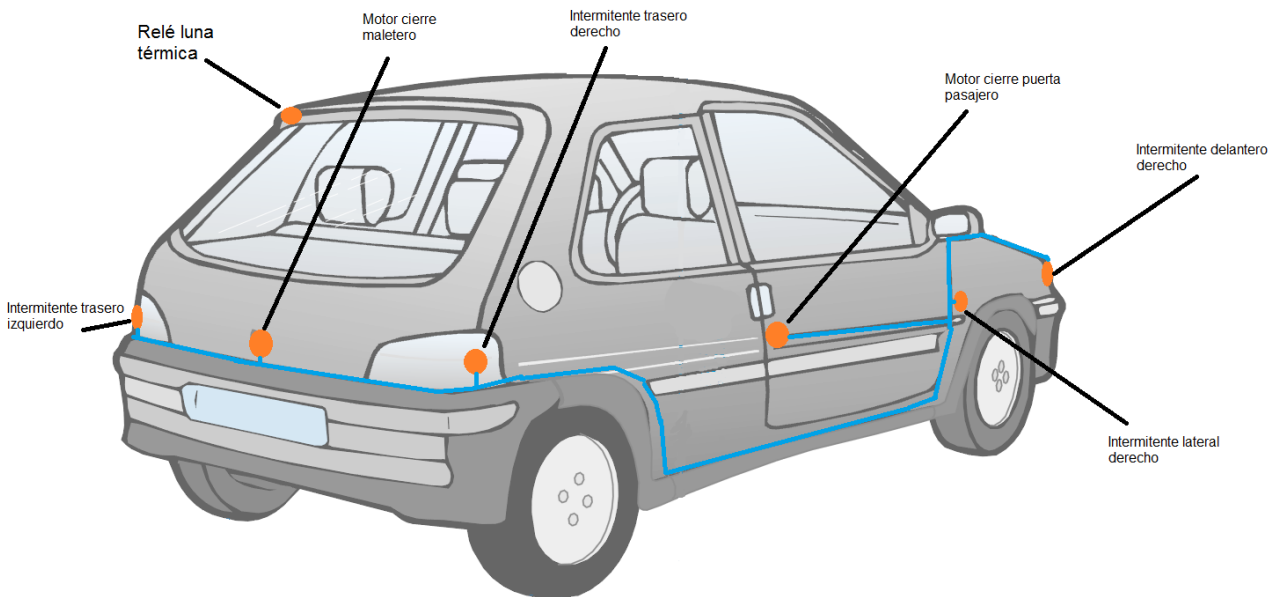

**Figura 28:** Esquema bus confort 2

- Longitud de cable necesaria (Metros): 12,7
- Número de puntos de conexión al bus necesarios: 18
- Número de transceptores y controladores necesarios: 9

### 7.3 Bus tracción

#### 7.3.1 Esquema general de las centralitas

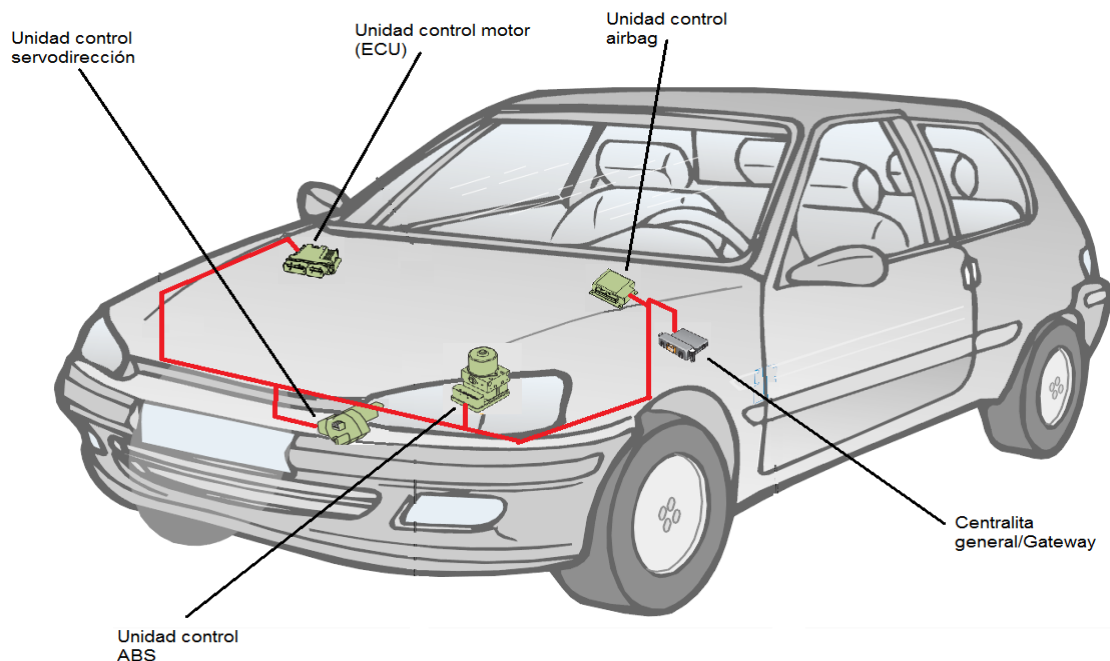

**Figura 29:** Esquema bus tracción

- Longitud de cable necesaria (Metros): 2,6
- Número de puntos de conexión al bus necesarios: 4
- Número de transceptores y controladores necesarios: 0

### 7.3.2 Esquema Bus Airbags

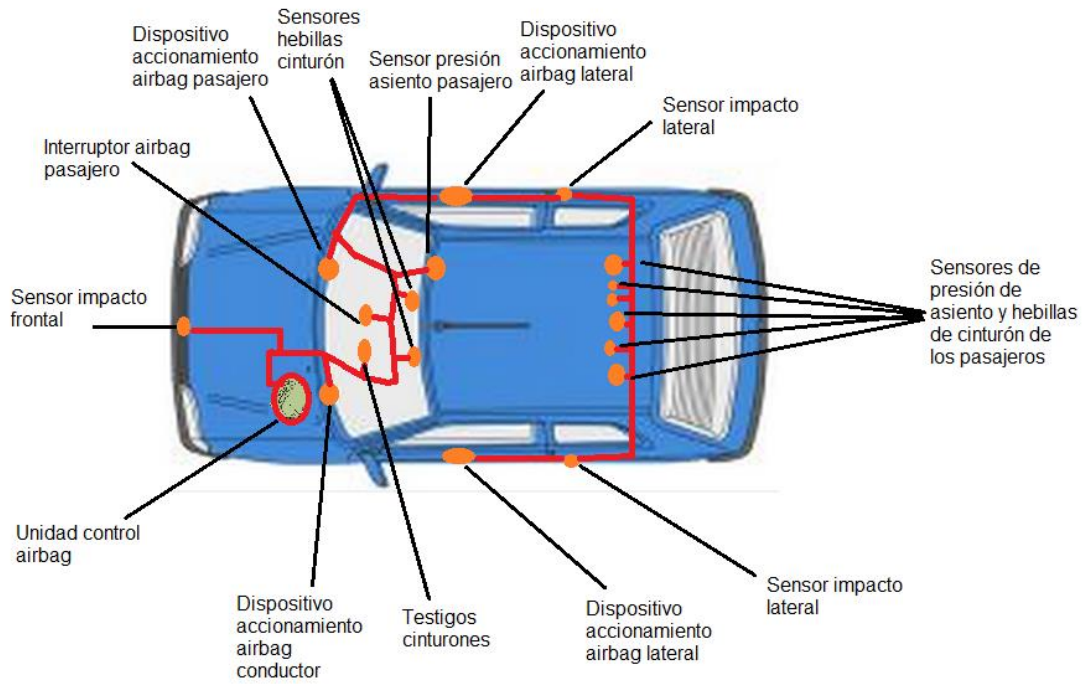

**Figura 30: Esquema bus airbags**

- Longitud de cable necesaria (Metros): 7,1
- Número de puntos de conexión al bus necesarios: 18
- Número de transceptores y controladores necesarios: 6

### 7.3.3 Esquema Bus control motor (ECU)

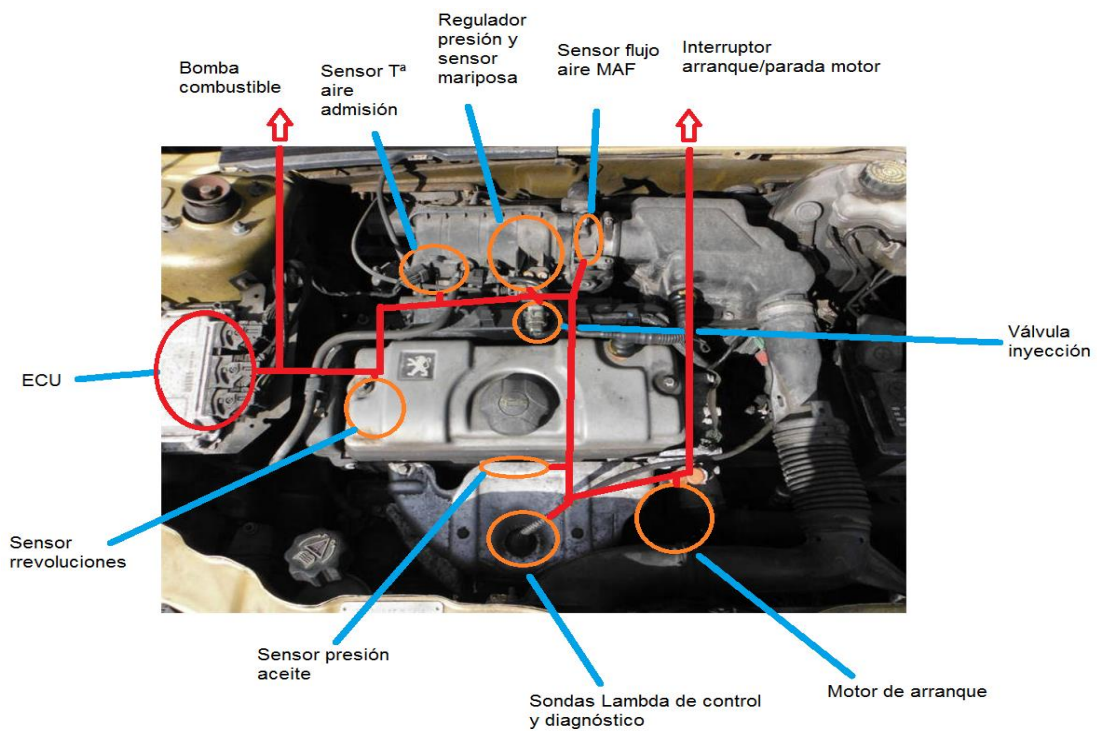

**Figura 31: Esquema bus ECU**

- Longitud de cable necesaria (Metros): 4,9
- Número de puntos de conexión al bus necesarios: 12
- Número de transceptores y controladores necesarios: 1

#### 7.3.4 Esquema Bus servodirección

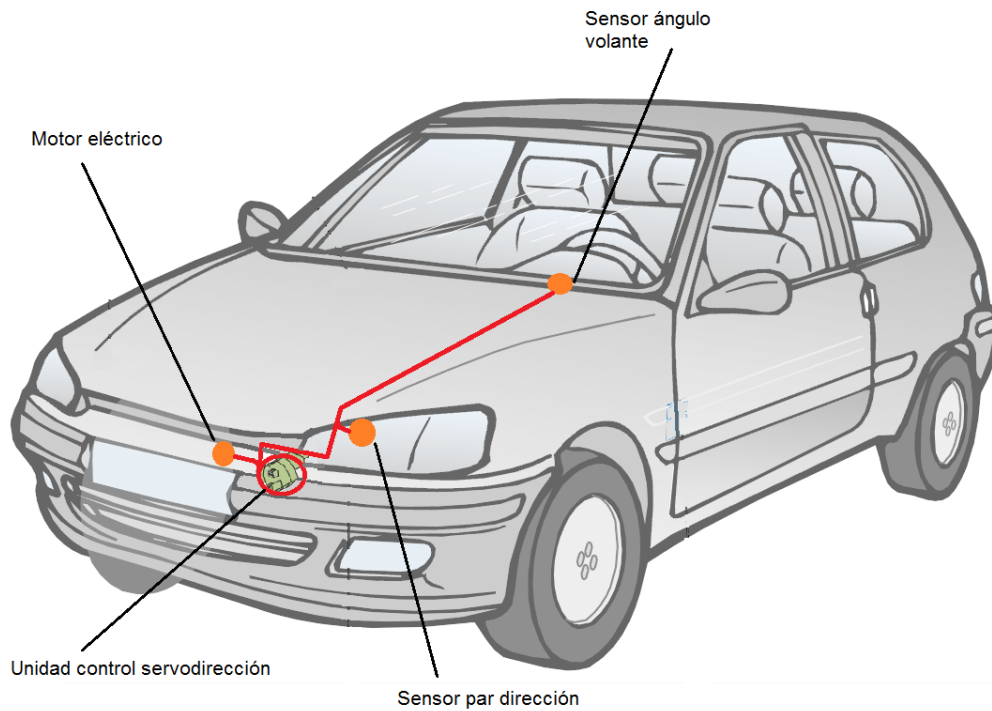

**Figura 32:** Esquema bus servodirección

- Longitud de cable necesaria (Metros): 2,2
- Número de puntos de conexión al bus necesarios: 3
- Número de transceptores y controladores necesarios: 1

### 7.3.5 Esquema Bus ABS

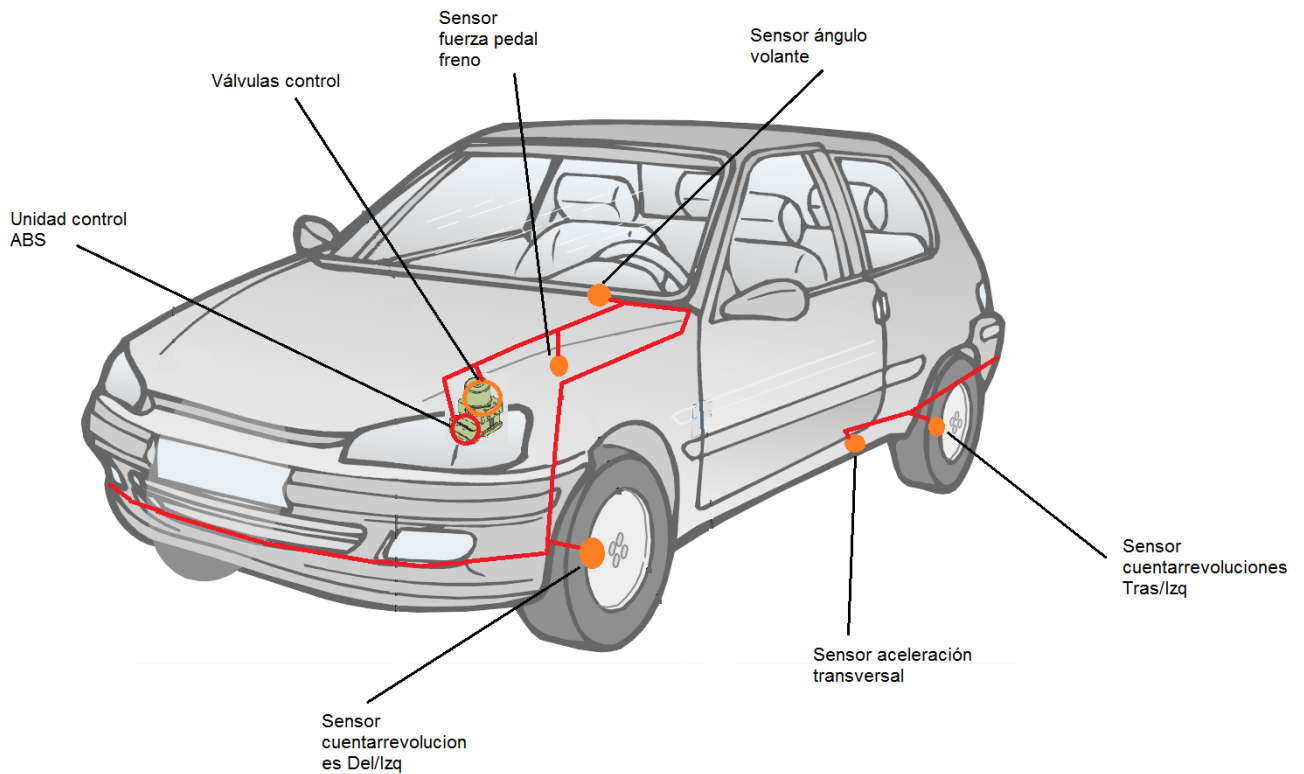

**Figura 33:** Esquema bus ABS

- Longitud de cable necesaria (Metros): 9,1
- Número de puntos de conexión al bus necesarios: 8
- Número de transceptores y controladores necesarios: 0

### 7.4 Bus panel mando volante

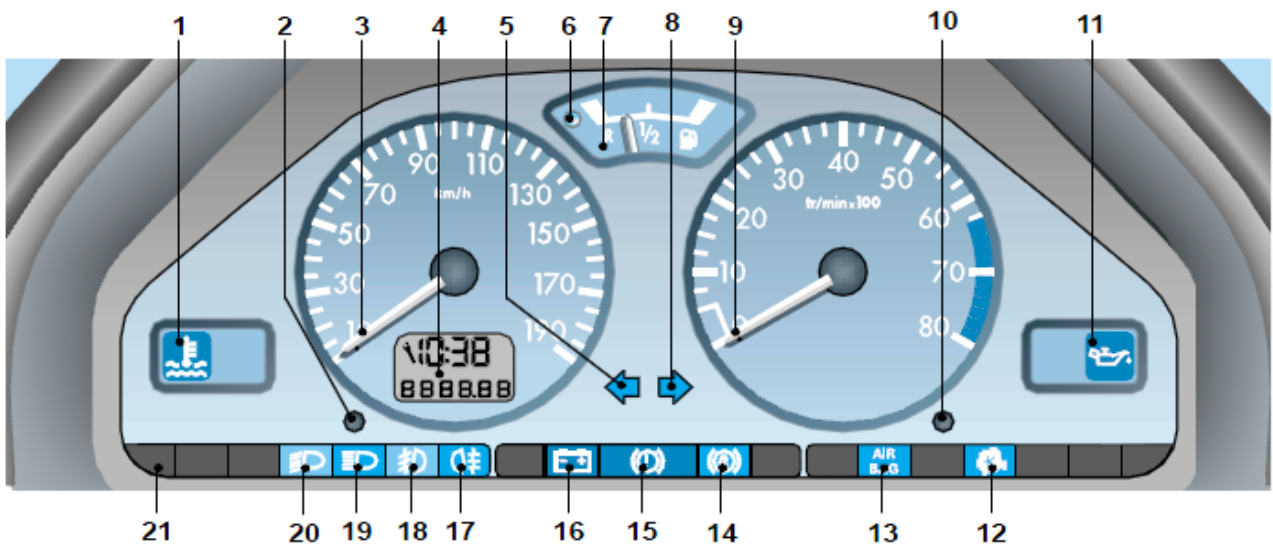

**Figura 34:** Esquema bus panel mando 1

Fuente: Manual de utilización Peugeot 106

1. T<sup>a</sup> máxima de líquido de refrigeración
2. Mando pantalla
3. Indicador velocidad
4. Pantalla cuentakilómetros/hora
5. Indicador cambio dirección izquierda
6. Nivel mínimo carburante
7. Indicador nivel carburante
8. Indicador cambio dirección derecha
9. Cuentarrevoluciones
10. Reglaje de la hora, reostato de iluminación
11. Presión aceite motor
12. Autodiagnos motor
13. Testigo airbags frontales y laterales
14. Testigo ABS
15. Freno de mano activado
16. Carga de batería
17. Luces trasera de niebla
18. Luces delanteras de niebla
19. Luces de carretera (Largas)
20. Luces de cruce (Cortas)
21. Neutralización airbag acompañante

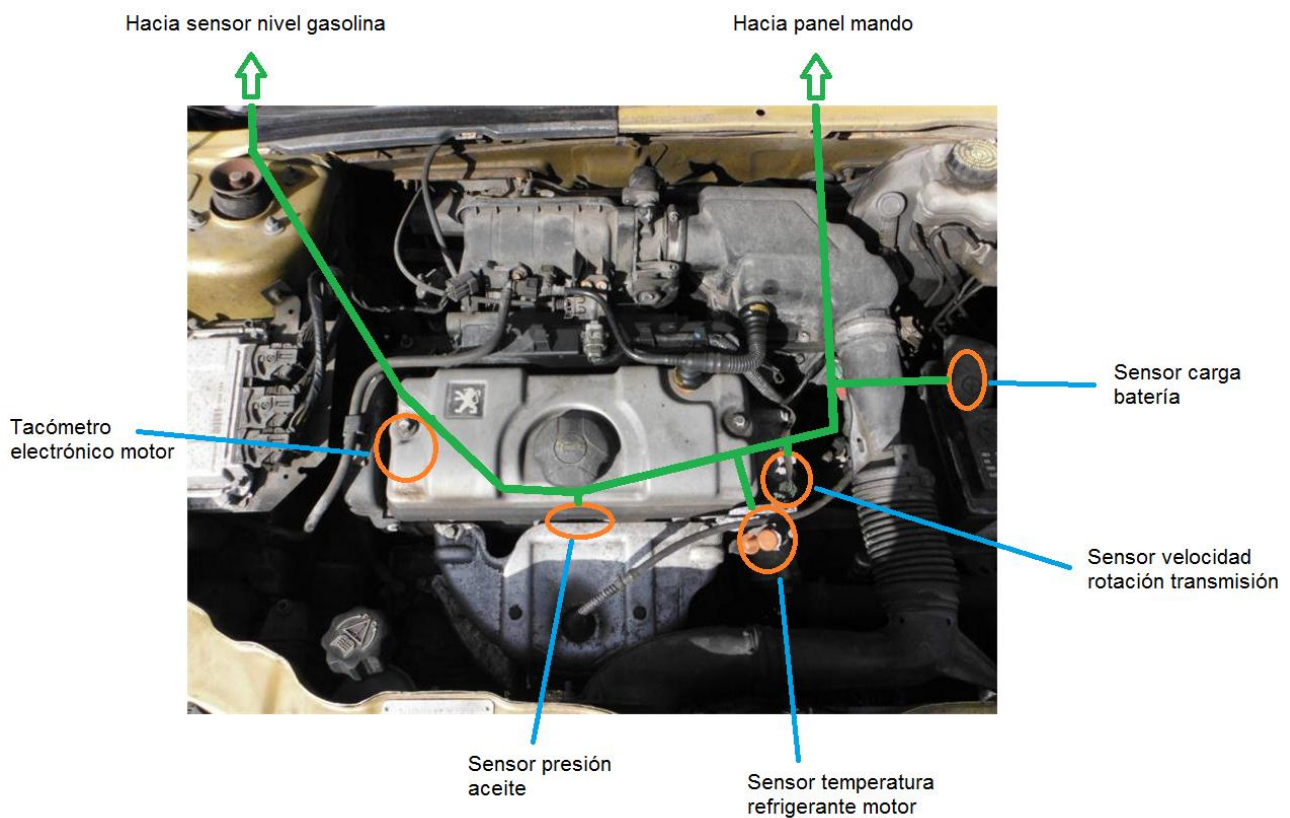

**Figura 35:** Esquema bus panel mando 2

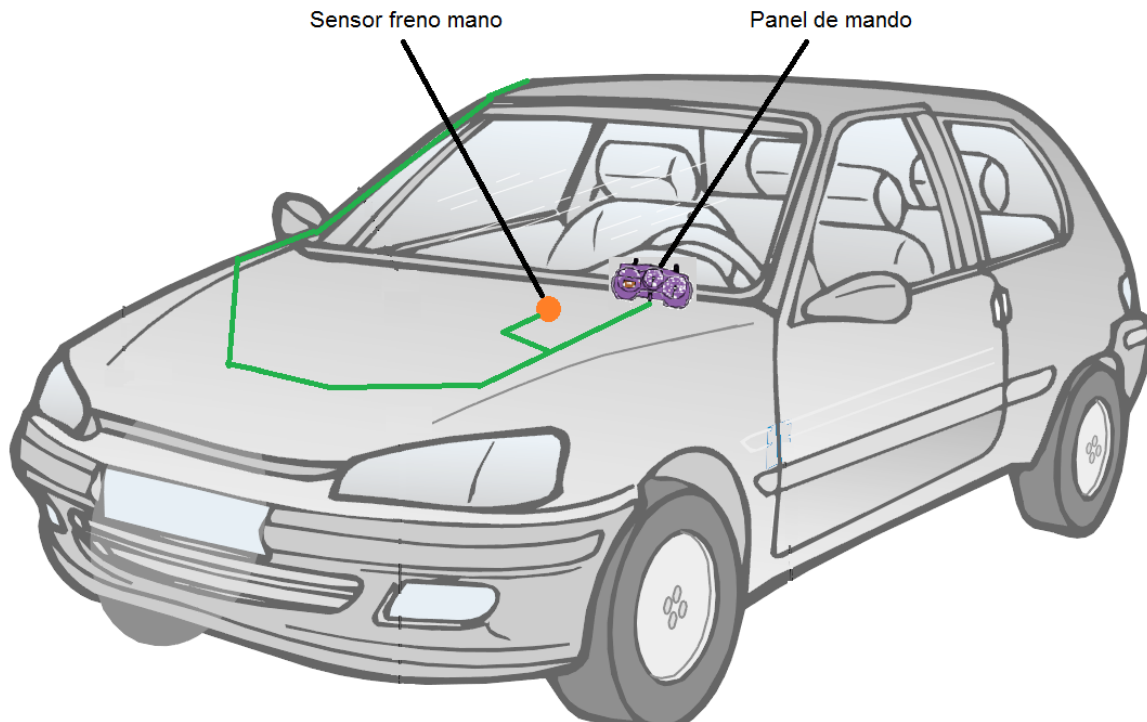

**Figura 36:** Esquema bus panel mando 3

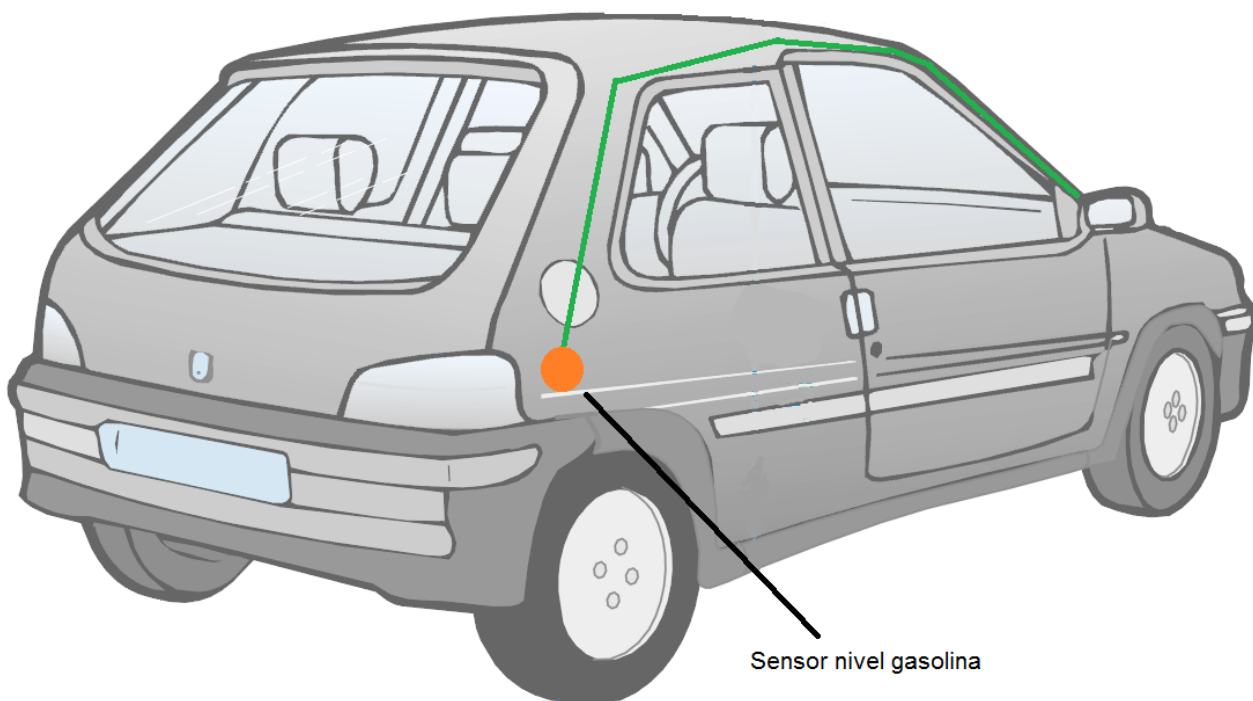

**Figura 37:** Esquema bus panel mando 4

- Longitud de cable necesaria (Metros): 9
- Número de puntos de conexión al bus necesarios: 8
- Número de transceptores y controladores necesarios: 2



## 8. Algoritmo de comunicaciones

Todos los sistemas que se van a implementar al vehículo tienen un tipo característico de señales para poder comunicarse con sus diferentes sensores, mandos y actuadores. Para poder estandarizar todo este tipo de señales la SAE (del inglés, *Society of Automotive Engineers*) creó en 1998 el conjunto de especificaciones (J1939), que definían como tenían que ser los diferentes mensajes en las comunicaciones relacionadas con el motor la transmisión y el frenado, para posteriormente completarse añadiendo más funciones y aplicaciones.

La capa física del SAE J1939 tiene las siguientes características:

- Uso CAN extendido (29 bit).
- Define una velocidad de 250 kbit/s.
- Máximo de 30 nodos por red.
- Longitud máxima de cable de 40 m.
- Par trenzado apantallado.
- Tolerancia de reloj de +/- 0,05%
- Comunicación del tipo punto a punto y *broadcast*.

Mientras que la capa de enlace tiene las siguientes características:

- Emplea la trama CAN 2.0B.
- Mientras que CAN se centra en el ID, J1939 se centra en el PGN (del inglés *Parameter Group Number*), definido por el CAN ID.
- La mayoría de los PGNs son de 8 bytes.

Los distintos mensajes y parámetros de un mismo tema se agrupan en distintos grupos y comparten la misma velocidad. Estos grupos son los llamados PGN y los distintos mensajes y parámetros son los SPN (del inglés, *Suspect Parameter Number*).

Todos los mensajes tienen un identificador CAN que está compuesto por el PGN, dirección de la fuente, prioridad, la data page bit y la extended data page bit. El formato de los mensajes es (Tabla 12):

**Tabla 12:** Formato mensajes SAE J1939

Prioridad	<i>Extended Data Page</i>	<i>Date Page</i>	Formato PDU	PDU específico	Dirección fuente
3 bit	1 bit	1 bit	8 bit	8 bit	8 bit

La prioridad del mensaje puede ser de 0 a 7, siendo 0 el mensaje con mayor prioridad, esto sirve para que ante la simultaneidad de dos mensajes enviados por distintos nodos puedan ser arbitrados según su prioridad.

Si el formato PDU es un número < 240, significa que es un mensaje del tipo punto a punto y no es llevado a todos los demás nodos solo al que el mensaje especifique, en este caso la trama PDU específico sirve para incluir la dirección del nodo a la cual debe ser transmitido el mensaje, en número PGN de estos mensajes se forma multiplicando Formato PDU por 256.

$$PGN = \text{Formato PDU} \cdot 256$$

Si por el contrario el formato PDU es un número >= 240, el mensaje será del tipo *broadcast* y todos los demás nodos lo recibirán, en este caso el PGN se forma multiplicando Formato PDU por 256 más el PDU específico del mensaje.

$$PGN = (\text{Formato PDU} \cdot 256) + \text{PDU Específico}$$

Con respecto a los bits de Extended Data page y Data Page, en el caso de nuestro estudio serán ambos dominantes (0) ya que seguiremos la norma SAE J1939.

En cuanto al SPN es el número que se le asigna a cada uno de los mensajes o parámetros del PGN. El SPN es un número de 19 bit que por lo tanto puede ir desde el 0 hasta el 524287, estando reservados de uso por norma los que van desde el 520192 hasta el 524287.

En el estudio no se han encontrado en la norma todas aquellas señales que hacen falta para controlar el vehículo, por ello se han creado algunas de ellas. Estas son todas aquellas que tienen un número de Formato PDU de 255, es decir que su PGN será mayor o igual de 65280 y los SPN añadidos tienen numeración desde el 5000 hacia adelante, esto es posible ya que el protocolo reserva estos números para uso específico de cada fabricante.

## 8.1 Comunicaciones en el bus de infotainment

### - Termómetro interior y exterior

#### **SPN 170 Cab Interior Temperature**

Temperature of air inside the part of the vehicle that encloses the driver and vehicle operating controls.

Data Length:	2 bytes	
Resolution:	0.03125 deg C/bit, -273 deg C offset	
Data Range:	-273 to 1735 deg C	Operational Range: same as data range
Type:	Measured	
Supporting information:		
PGN	65269	

---

#### **SPN 171 Ambient Air Temperature**

Temperature of air surrounding vehicle.

Data Length:	2 bytes	
Resolution:	0.03125 deg C/bit, -273 deg C offset	
Data Range:	-273 to 1735 deg C	Operational Range: same as data range
Type:	Measured	
Supporting information:		
PGN	65269	

---

#### **PGN 65269 Ambient Conditions**

**- AMB**

Transmission Repetition Rate:	1 s	
Data Length:	8	
Extended Data Page:	0	
Data Page:	0	
PDU Format:	254	
PDU Specific:	245	PGN Supporting Information:

Default Priority: 6  
 Parameter Group Number: 65269 (0xFEf5)

Start Position	Length	Parameter Name	SPN
1	1 byte	Barometric Pressure	108
<b>2-3</b>	<b>2 bytes</b>	<b>Cab Interior Temperature</b>	<b>170</b>
<b>4-5</b>	<b>2 bytes</b>	<b>Ambient Air Temperature</b>	<b>171</b>
6	1 byte	Engine Air Inlet Temperature	172
7-8	2 bytes	Road Surface Temperature	79

- Asistencia aparcamiento

**SPN 5016 Parking Assist System**

It indicates the proximity of an object to the vehicle by proximity sensors.

- Bit 1: (0) sensor 1 de-activated, (1) sensor 1 activated
- Bit 2: (0) sensor 2 de-activated, (1) sensor 2 activated
- Bit 3: (0) sensor 3 de-activated, (1) sensor 3 activated
- Bit 4: (0) sensor 4 de-activated, (1) sensor 4 activated
- Bit 5: (0) sensor 5 de-activated, (1) sensor 5 activated
- Bit 6: (0) sensor 6 de-activated, (1) sensor 6 activated
- Bit 7: (0) sensor 7 de-activated, (1) sensor 7 activated
- Bit 8: (0) sensor 8 de-activated, (1) sensor 8 activated

Data Length: 1 byte  
 Resolution: 256 states/8 bit, 0 offset  
 Data Range: 0 to 255  
 Type: Status  
 Supporting information:  
 PGN 65285

Operational Range: same as data range

**PGN 65285 Parking Assist**

**- PAS**

Parking Assist related parameters.

Transmission Repetition Rate: 100 ms  
 Data Length: 8  
 Extended Data Page: 0  
 Data Page: 0  
 PDU Format: 255  
 PDU Specific: 5  
 Default Priority: 4  
 Parameter Group Number: 65285

PGN Supporting Information:  
(0xFF05)

Start Position	Length	Parameter Name	SPN
1.1	1 byte	<b>Parking Assist System</b>	<b>5 016</b>

- Sistema de aviso cambio carril

### ***SPN 1700 Lane Departure Imminent, Left Side***

Indicates departure imminent on left side of lane.

00 Not imminent  
01 Imminent  
10 Reserved  
11 Not used

Data Length: 2 bits  
Resolution: 4 states/2 bit, 0 offset  
Data Range: 0 to 3  
Type: Status  
Supporting information:  
PGN 61447

Operational Range: same as data range

---

### ***SPN 1701 Lane Departure Imminent, Right Side***

Indicates departure imminent on right side of lane.

00 Not imminent  
01 Imminent  
10 Reserved  
11 Not Used

Data Length: 2 bits  
Resolution: 4 states/2 bit, 0 offset  
Data Range: 0 to 3  
Type: Status  
Supporting information:  
PGN 61447

Operational Range: same as data range

---

### ***SPN 3565 Lane Departure Left***

Indicates that the middle of vehicle departs the lane on the left side. The parameter indicates that the vehicle is changing the lane to the left.

00 Middle of the vehicle does not depart the lane to the left side  
01 Middle of the vehicle departs the lane to the left side  
10 Reserved  
11 Take no action

Data Length: 2 bits  
Resolution: 4 states/2 bit, 0 offset  
Data Range: 0 to 3  
Type: Status  
Supporting information:  
PGN 61447

Operational Range: same as data range

---

### **SPN 3566 Lane Departure Right**

Indicates that the middle of vehicle departs the lane on the right side. The parameter indicates that the vehicle is changing the lane to the right.

00 Middle of the vehicle does not depart the lane to the right side

01 Middle of the vehicle departs the lane to the right side

10 Reserved

11 Take no action

Data Length: 2 bits

Resolution: 4 states/2 bit, 0 offset

Data Range: 0 to 3

Operational Range: same as data range

Type: Status

Supporting information:

PGN 61447

---

### **PGN 61447 Forward Lane Image urgent msg**

**- FLI1**

Transmission Repetition Rate: 50 ms (only when active)

Data Length: 8

Extended Data Page: 0

Data Page: 0

PDU Format: 240

PDU Specific: 7

PGN Supporting Information:

Default Priority: 4

Parameter Group Number: 61447 (0xF007)

Start Position	Length	Parameter Name	SPN
1.1	2 bits	Lane Departure Left	3565
1.3	2 bits	Lane Departure Right	3566
1.5	2 bits	Lane Departure Imminent, Right Side	1701
1.7	2 bits	Lane Departure Imminent, Left Side	1700

## 8.2 Comunicaciones en el bus de confort

### - Control cierre puertas

#### **SPN 1821 Position of doors**

Signal which indicates the actual position of the doors.

0000 At least 1 door is open  
0001 Closing last door  
0010 All doors closed  
0011-1101 not defined  
1110 Error  
1111 Not available

Data Length: 4 bits  
Resolution: 16 states/4 bit, 0 offset  
Data Range: 0 to 15  
Type: Measured  
Supporting information:  
PGN 65102

Operational Range: same as data range

---

#### **PGN 65102 Door Control 1**

**- DC1**

Used for door information.

Transmission Repetition Rate: 100 ms  
Data Length: 8  
Extended Data Page: 0  
Data Page: 0  
PDU Format: 254  
PDU Specific: 78  
Default Priority: 6  
Parameter Group Number: 65102

PGN Supporting Information:  
(0xFE4E)

Start Position	Length	Parameter Name	SPN
1.1	4 bits	<b>Position of doors</b>	<b>1821</b>
1.5	2 bits	Ramp / Wheel Chair Lift Position	1820
1.7	2 bits	Status 2 of doors	3411

- Retrovisores eléctricos

### ***SPN 5000 Angle Rearview Left/Right***

Command to modify the angle of the rearview in both.

00 De-activated  
01 Angle to left  
10 Angle to right  
11 Reserved

Data Length: 2 bits  
Resolution: 4 states/2 bit, 0 offset  
Data Range: 0 to 3  
Type: Status  
Supporting information:  
PGN 65280

Operational Range: same as data range

---

### ***SPN 5001 Angle Rearview Up/Down***

Command to move the rearview to up or down.

00 De-activated  
01 Angle to down  
10 Angle to up  
11 Reserved

Data Length: 2 bits  
Resolution: 4 states/2 bit, 0 offset  
Data Range: 0 to 3  
Type: Status  
Supporting information:  
PGN 65280

Operational Range: same as data range

- Asiento eléctrico

### ***SPN 5002 Seat Backward / Forward***

Command that moves the seat backward or forward

00 De-activated  
01 Seat back  
10 Seating forward  
11 Reserved

Data Length: 2 bits  
Resolution: 4 states/2 bit, 0 offset  
Data Range: 0 to 3  
Type: Status  
Supporting information:  
PGN 65280

Operational Range: same as data range

---

### ***SPN 5003 Angle Backrest***

Command changes the angle of the backrest

00 De-activated  
01 increases the angle  
10 decreases the angle  
11 Reserved

Data Length: 2 bits  
Resolution: 4 states/2 bit, 0 offset  
Data Range: 0 to 3  
Type: Status  
Supporting information:  
PGN 65280

Operational Range: same as data range

- Elevalunas eléctrico

### ***SPN 5004 Electric Window Motor Up***

Command that activates the window motor up.

00 De-activated  
01 Activated  
10 Reserved  
11 Don't Care

Data Length: 2 bits  
Resolution: 4 states/2 bit, 0 offset  
Data Range: 0 to 3  
Type: Status  
Supporting information:  
PGN 65280

Operational Range: same as data range

---

### ***SPN 5005 Electric Window Motor Down***

Command that activates the window motor down.

00 De-activated  
01 Activated  
10 Reserved  
11 Don't Care

Data Length: 2 bits  
Resolution: 4 states/2 bit, 0 offset  
Data Range: 0 to 3  
Type: Status  
Supporting information:  
PGN 65280

Operational Range: same as data range

---



**PGN 65280 Control Unit Door Systems**

**- DOO**

Control Unit Door Systems related parameters

Transmission Repetition Rate:	0.5 s	
Data Length:	8	
Extended Data Page:	0	
Data Page:	0	
PDU Format:	255	
PDU Specific:	0	PGN Supporting Information:
Default Priority:	6	
Parameter Group Number:	65280	(0xFF00)

Start Position	Length	Parameter Name	SPN
1.1	2 bits	Angle Rearview Left/Right	5 000
1.3	2 bits	Angle Rearview Up/Down	5 001
1.5	2 bits	Seat Backward / Forward	5 002
1.7	2 bits	Angle Backrest	5 003
2.1	2 bits	Electric Window Motor Up	5 004
2.3	2 bits	Electric Window Motor Down	5 005

- Sistema de calefacción y aire acondicionado

**SPN 5006 Climate Control**

It indicates the temperature to be achieved inside the vehicle.

Data Length:	5 bit	
Resolution:	0.94 °C/bit, 0 offset	
Data Range:	10°C to 40°C	Operational Range: same as data range
Type:	Measured	
Supporting information:		
PGN	65281	

- Asientos térmicos

**SPN 5013 Driver's Heated Seat**

Command that enables or disables the driver heated seat.

- 00 De-activated
- 01 Activated
- 10 Reserved
- 11 Don't Care

Data Length:	2 bits	
Resolution:	4 states/2 bit, 0 offset	
Data Range:	0 to 3	Operational Range: same as data range
Type:	Status	
Supporting information:		
PGN	65281	

### **SPN 5014 Passenger's Heated Seat**

Command that enables or disables the passenger heated seat.

00 De-activated  
01 Activated  
10 Reserved  
11 Don't Care

Data Length: 2 bits  
Resolution: 4 states/2 bit, 0 offset  
Data Range: 0 to 3  
Type: Status  
Supporting information:  
PGN 65281

Operational Range: same as data range

---

### **PGN 65281 Climatic system**

**– CLI**

Climatic system related parameters

Transmission Repetition Rate: 1 s  
Data Length: 8  
Extended Data Page: 0  
Data Page: 0  
PDU Format: 255  
PDU Specific: 1  
Default Priority: 7  
Parameter Group Number: 65281

PGN Supporting Information:  
(0xFF01)

Start Position	Length	Parameter Name	SPN
1.1	5 bits	Climate Control	5 006
2.1	2 bits	Driver's Heated Seat	5 013
2.3	2 bits	Passenger's Heated Seat	5 014

- Limpiaparabrisas

### **SPN 5007 Windshield Wiper**

Command that enables or disables the different speeds of the front wiper and the wash pump.

000 De-activated wiper and wash pump  
001 Speed 1  
010 Speed 2  
011 Speed 3  
100 Speed 1 and wash pump  
101 Speed 2 and wash pump  
110 Speed 3 and wash pump  
111 Reserved

Data Length: 3 bits  
Resolution: 8 states/3 bit, 0 offset  
Data Range: 0 to 3  
Type: Status  
Supporting information:  
PGN 65282

Operational Range: same as data range

### **SPN 5008 Rear Wiper**

Command that enables or disables the rear wiper and the wash pump.

- 00 De-activated wiper and wash pump
- 01 Activated wiper
- 10 Activated wiper and wash pump
- 11 Reserved

Data Length: 2 bits  
Resolution: 4 states/3 bit, 0 offset  
Data Range: 0 to 3  
Type: Status  
Supporting information:  
PGN 65282

Operational Range: same as data range

- Claxon

### **SPN 5009 Horn**

Command activates or deactivates the horn.

- 00 De-activated
- 01 Activated
- 10 Reserved
- 11 Don't Care

Data Length: 2 bits  
Resolution: 4 states/2 bit, 0 offset  
Data Range: 0 to 3  
Type: Status  
Supporting information:  
PGN 65282

Operational Range: same as data range

---

### **PGN 65282 Steering Column Systems**

**– WIHO**

Wipers and horn related parameters

Transmission Repetition Rate: 100 ms  
Data Length: 8  
Extended Data Page: 0  
Data Page: 0  
PDU Format: 255  
PDU Specific: 2  
Default Priority: 3  
Parameter Group Number: 65282

PGN Supporting Information:  
(0xFF02)

Start Position	Length	Parameter Name	SPN
1.1	3 bits	Windshield Wiper	5 007
1.5	2 bits	Rear Wiper	5 008
2.1	2 bits	Horn	5 009

- Luces

### **SPN 5030 Vehicle Marker Light Command**

Command to activate or de-activate vehicle and implement front position lights, rear red tail lights, side amber running lights, license plate lights and instrument and switch back lights.

00 De-activate  
01 Activate  
10 Reserved  
11 Don't Care

Data Length: 2 bits  
Resolution: 4 states/2 bit, 0 offset  
Data Range: 0 to 3  
Type: Status  
Supporting information:  
PGN 65290

Operational Range: same as data range

---

### **SPN 5031 High Beam Head Light Command**

Command to activate or de-activate the vehicle high beam head light lamps.

00 De-activate  
01 Activate  
10 Reserved  
11 Don't Care

Data Length: 2 bits  
Resolution: 4 states/2 bit, 0 offset  
Data Range: 0 to 3  
Type: Status  
Supporting information:  
PGN 65290

Operational Range: same as data range

---

### **SPN 5032 Brake Light Command**

Command to activate or de-activate the vehicle brake light lamps.

00 De-activate  
01 Activate  
10 Reserved  
11 Don't Care

Data Length: 2 bits  
Resolution: 4 states/2 bit, 0 offset  
Data Range: 0 to 3  
Type: Status  
Supporting information:  
PGN 65290

Operational Range: same as data range

---

### ***SPN 5033 Left Turn Signal Lights Command***

Command to activate or de-activate left turn signal lights on the vehicle and all connected implements.

00 De-activate  
01 Activate  
10 Reserved  
11 Don't Care

Data Length: 2 bits  
Resolution: 4 states/2 bit, 0 offset  
Data Range: 0 to 3 Operational Range: same as data range  
Type: Status  
Supporting information:  
PGN 65290

---

### ***SPN 5034 Right Turn Signal Lights Command***

Command to activate or de-activate right turn signal lights on the vehicle and all connected implements.

00 De-activate  
01 Activate  
10 Reserved  
11 Don't Care

Data Length: 2 bits  
Resolution: 4 states/2 bit, 0 offset  
Data Range: 0 to 3 Operational Range: same as data range  
Type: Status  
Supporting information:  
PGN 65290

---

### ***SPN 5035 Vehicle Front Fog Lights Command***

Command to activate or de-activate vehicle front fog lights.

00 De-activate  
01 Activate  
10 Reserved  
11 Don't Care

Data Length: 2 bits  
Resolution: 4 states/2 bit, 0 offset  
Data Range: 0 to 3 Operational Range: same as data range  
Type: Status  
Supporting information:  
PGN 65290

---

### **SPN 5036 Rear Fog Light Command**

Command to activate or de-activate tractor or implement rear fog lights.

00 De-activate  
01 Activate  
10 Reserved  
11 Don't Care

Data Length: 2 bits  
Resolution: 4 states/2 bit, 0 offset  
Data Range: 0 to 3  
Type: Status  
Supporting information:  
PGN 65290

Operational Range: same as data range

---

### **PGN 65089 Lighting Command 2**

**- LC2**

The lighting command message has been defined as a global message from the vehicle to all lighting controllers on the vehicle and attached implements. Separate messages are provided for vehicle and implement work and driving lights. Common marking and signaling messages are provided.

This message is used to control the state of all lighting functions. The lighting command message shall be sent on each change of state of a lamp. The state values indicate the lights is to be turned ON or OFF.

Flashing is accomplished by sending the lighting message with the state alternately ON or OFF. A lighting command message must be sent at least once per second. It is the responsibility of the tractor designer to provide the correct combination of lamp commands to meet local legislative directives.

Transmission Repetition Rate: On change of lamp on/ off state. Maximum period of 1 second between messages. No greater than 10 messages per second for all lights.

Data Length: 8  
Extended Data Page: 0  
Data Page: 0  
PDU Format: 255  
PDU Specific: 10  
Default Priority: 3  
Parameter Group Number: 65290

PGN Supporting Information:  
(0xFF0A)

Start Position	Length	Parameter Name	SPN
1.1	2 bits	Tractor Marker Light Command	5030
1.3	2 bits	High Beam Head Light Command	5031
1.5	2 bits	Brake Light Command	5032
1.7	2 bits	Left Turn Signal Lights Command	5033
2.1	2 bits	Right Turn Signal Lights Command	5034
2.3	2 bits	Tractor Front Fog Lights Command	5035
2.5	2 bits	Rear Fog Light Command	5036

- Cierre centralizado

### ***SPN 5010 Central Locking***

Command to open or close all doors and lock the vehicle.

00 De-activated  
01 Activated  
10 Reserved  
11 Don't Care

Data Length:	2 bits	
Resolution:	4 states/2 bit, 0 offset	
Data Range:	0 to 3	Operational Range: same as data range
Type:	Status	
Supporting information:		
PGN	65283	

- Techo Solar

### ***SPN 5011 Sunroof***

Command to open or close the sunroof.

00 De-activated  
01 Activated  
10 Reserved  
11 Don't Care

Data Length:	2 bits	
Resolution:	4 states/2 bit, 0 offset	
Data Range:	0 to 3	Operational Range: same as data range
Type:	Status	
Supporting information:		
PGN	65283	

- Luna térmica trasera

### ***SPN 5012 Rear Window Heating***

Command activates or deactivates the heating of the rear window of the vehicle.

00 De-activated  
01 Activated  
10 Reserved  
11 Don't Care

Data Length:	2 bits	
Resolution:	4 states/2 bit, 0 offset	
Data Range:	0 to 3	Operational Range: same as data range
Type:	Status	
Supporting information:		
PGN	65283	

- Control luces encendidas

### **SPN 5015 Lighting Control**

Indicates if there is any light on the vehicle by an acoustic signal if the engine is stopped.

00 De-activated  
 01 Activated  
 10 Reserved  
 11 Don't Care

Data Length: 2 bits  
 Resolution: 4 states/2 bit, 0 offset  
 Data Range: 0 to 3  
 Type: Status  
 Supporting information:  
 PGN 65283

Operational Range: same as data range

### **PGN 65283 Comfort Systems**

- CSY

Comfort system related parameters

Transmission Repetition Rate: 100 ms  
 Data Length: 8  
 Extended Data Page: 0  
 Data Page: 0  
 PDU Format: 255  
 PDU Specific: 3  
 Default Priority: 6  
 Parameter Group Number: 65283

PGN Supporting Information:  
(0xFF03)

Start Position	Length	Parameter Name	SPN
1.1	2 bits	Central Locking	5 010
1.3	2 bits	Sunroof	5 011
1.5	2 bits	Rear Window Heating	5 012
1.7	2 bits	Lighting Control	5 015

- Botón señal emergencia

### **SPN 2367 Left Turn Signal Lights Command**

Command to activate or de-activate left turn signal lights on the vehicle and all connected implements.

00 De-activate  
 01 Activate  
 10 Reserved  
 11 Don't Care

Data Length: 2 bits  
 Resolution: 4 states/2 bit, 0 offset  
 Data Range: 0 to 3  
 Type: Status  
 Supporting information:  
 PGN 65089

Operational Range: same as data range



### ***SPN 2368 Left Turn Signal Lights***

This parameter provides measured data from the vehicle and attached implement left turn signal lights.

00 De-activated  
01 Activated  
10 Fault Detected  
11 Not Available

Data Length: 2 bits  
Resolution: 4 states/2 bit, 0 offset  
Data Range: 0 to 3  
Type: Measured  
Supporting information:  
PGN 65088

Operational Range: same as data range

---

### ***SPN 2369 Right Turn Signal Lights Command***

Command to activate or de-activate right turn signal lights on the vehicle and all connected implements.

00 De-activate  
01 Activate  
10 Reserved  
11 Don't Care

Data Length: 2 bits  
Resolution: 4 states/2 bit, 0 offset  
Data Range: 0 to 3  
Type: Status  
Supporting information:  
PGN 65089

Operational Range: same as data range

---

### ***SPN 2370 Right Turn Signal Lights***

This parameter provides measured data from the vehicle and attached implement right turn signal lights.

00 De-activated  
01 Activated  
10 Fault Detected  
11 Not Available

Data Length: 2 bits  
Resolution: 4 states/2 bit, 0 offset  
Data Range: 0 to 3  
Type: Measured  
Supporting information:  
PGN 65088

Operational Range: same as data range

---

\*Ver PGNs en el apartado Luces

- Luz interior

**SPN 5000 Interior light**

Command to activate or de-activate interior light.

- 00 De-activate
- 01 Activate
- 10 Reserved
- 11 Don't Care

Data Length: 2 bits  
Resolution: 4 states/2 bit, 0 offset  
Data Range: 0 to 3  
Type: Status  
Supporting information:  
PGN 650284

Operational Range: same as data range

---

**PGN 65284 Interior Light**

**- ILI**

Comfort system related parameters.

Transmission Repetition Rate: 100 ms  
Data Length: 8  
Extended Data Page: 0  
Data Page: 0  
PDU Format: 255  
PDU Specific: 4  
Default Priority: 6  
Parameter Group Number: 65284

PGN Supporting Information:  
(0xFF04)

Start Position	Length	Parameter Name	SPN
1.1	2 bits	Interior light	5 025

### 8.3 Comunicaciones en el bus de tracción

#### - Airbags

##### **SPN 5017 Driver Airbag**

Command that activates the airbag when an impact by the impact sensors is collected.

- 00 De-activated
- 01 Active front impact sensor. Activates the driver's airbag.
- 10 Reserved
- 11 Don't care

Data Length: 2 bits  
Resolution: 4 states/2 bit, 0 offset  
Data Range: 0 to 3                      Operational Range: same as data range  
Type: Status  
Supporting information:  
PGN 65286

---

##### **SPN 5018 Passenger Airbag Activated / De-activated**

Command activates or deactivates the passenger airbag system for inclusion a child seat.

- 00 De-activated
- 01 Activated
- 10 Reserved
- 11 Don't Care

Data Length: 2 bits  
Resolution: 4 states/2 bit, 0 offset  
Data Range: 0 to 3                      Operational Range: same as data range  
Type: Status  
Supporting information:  
PGN 65286

---

##### **SPN 5019 Passenger airbags**

Command that activates the airbag if an impact is reflected by front impact sensors and pressure sensor detects that passengers in their seats persons.

- 00 De-activated
- 01 Pressure sensor active. Passenger airbag de-activated
- 10 Front impact sensor active. Airbag de-activated
- 11 Both active sensors activated airbag

Data Length: 2 bits  
Resolution: 4 states/2 bit, 0 offset  
Data Range: 0 to 3                      Operational Range: same as data range  
Type: Status  
Supporting information:  
PGN 65286

### **SPN 5020 Side Airbags**

Command that enables or disables the system side airbags for the driver and if the side impact sensor recognizes an impact.

- 00 De-activated
- 01 Side impact sensor activated. Airbag activated.
- 10 Reserved
- 11 Don't care

Data Length: 2 bits  
Resolution: 4 states/2 bit, 0 offset  
Data Range: 0 to 3  
Type: Status  
Supporting information:  
PGN 65286

Operational Range: same as data range

---

### **PGN 65286 Airbags Controller 1**

**- ABC 1**

Airbags related parameters.

Transmission Repetition Rate: 100 ms  
Data Length: 8  
Extended Data Page: 0  
Data Page: 0  
PDU Format: 255  
PDU Specific: 6  
Default Priority: 1  
Parameter Group Number: 65286

PGN Supporting Information:  
(0xFF06)

Start Position	Length	Parameter Name	SPN
1.1	2 bits	Driver Airbag	5 017
1.3	2 bits	Passenger Airbag Activated / De-activated	5 018
1.5	2 bits	Passenger airbags	5 019
1.7	2 bits	Side Airbags	5 020

- Control cinturones

### **SPN 1856 Seat Belt Switch**

State of switch used to determine if Seat Belt is buckled.

- 00 NOT Buckled
- 01 OK - Seat Belt is buckled
- 10 Error - Switch state cannot be determined
- 11 Not Available

Data Length: 2 bits  
Resolution: 4 states/2 bit, 0 offset  
Data Range: 0 to 3  
Type: Measured  
Supporting information:  
PGN 57344

Operational Range: same as data range

---

**PGN 57344 Cab Message 1****- CM1**

Message containing parameters originating from the vehicle cab.

Transmission Repetition Rate: 1 s  
Data Length: 8  
Extended Data Page: 0  
Data Page: 0  
PDU Format: 224  
PDU Specific: DA PGN Supporting Information:  
Default Priority: 6  
Parameter Group Number: 57344 (0xE000)

Start Position	Length	Parameter Name	SPN
4.7	2 bits	Seat Belt Switch	1856

- Inyección electrónica

**SPN 94 Engine Fuel Delivery Pressure**

Gage pressure of fuel in system as delivered from supply pump to the injection pump. See Figures SPN16\_A & SPN16\_B.

Data Length: 1 byte  
Resolution: 4 kPa/bit, 0 offset  
Data Range: 0 to 1000 kPa Operational Range: same as data range  
Type: Measured  
Supporting information:  
PGN 65263

---

**SPN 132 Engine Inlet Air Mass Flow Rate**

Mass flow rate of fresh air entering the engine air intake, before any EGR mixer, if used. Flow rate of fresh air conducted to the engine cylinders to support combustion.

Data Length: 2 bytes  
Resolution: 0.05 kg/h per bit, 0 offset  
Data Range: 0 to 3212.75 kg/h Operational Range: same as data range  
Type: Measured  
Supporting information:  
PGN 61450

### ***SPN 164 Engine Injection Control Pressure***

The gage pressure of the engine oil in the hydraulic accumulator that powers an intensifier used for fuel injection.

Data Length:	2 bytes	
Resolution:	1/256 MPa/bit, 0 offset	
Data Range:	0 to 251 Mpa	Operational Range: same as data range
Type:	Measured	
Supporting information:		
PGN	65243	

---

### ***SPN 172 Engine Air Inlet Temperature***

Temperature of air entering vehicle air induction system.

Data Length:	1 byte	
Resolution:	1 deg C/bit, -40 deg C offset	
Data Range:	-40 to 210 deg C	Operational Range: same as data range
Type:	Measured	
Supporting information:		
PGN	65269	

---

### ***SPN 190 Engine Speed***

Actual engine speed which is calculated over a minimum crankshaft angle of 720 degrees divided by the number of cylinders.

Data Length:	2 bytes	
Resolution:	0.125 rpm/bit, 0 offset	
Data Range:	0 to 8,031.875 rpm	Operational Range: same as data range
Type:	Measured	
Supporting information:		
PGN	61444	

---

### ***SPN 1442 Engine Fuel Valve 1 Position (Posición válvula)***

The position of a gaseous fuel valve that is metering the fuel flow to the engine. 0% indicates no fuel flow through valve and 100% means maximum fuel flow through valve.

Data Length:	1 byte	
Resolution:	0.4 %/bit, 0 offset	
Data Range:	0 to 100 %	Operational Range: same as data range
Type:	Measured	
Supporting information:		
PGN	65153	

---

### **SPN 1765 Engine Requested Fuel Valve 1 Position**

The requested position of a gaseous fuel valve 1 that is metering the fuel flow to the engine.

Data Length: 1 byte  
Resolution: 0.4 %/bit, 0 offset  
Data Range: 0 to 100 % Operational Range: same as data range  
Type: Status  
Supporting information:  
PGN 65153

---

### **SPN 4082 Fuel Pump Primer Control**

Parameter used to activate or deactivate a priming system on the fuel transfer system. The fuel priming system is a system that purges air in the fuel lines and may assist fuel delivery to a second pump at lower speeds.

00 = Deactivate  
01 = Activate  
10 = Reserved  
11 = Unavailable

Data Length: 2 bits  
Resolution: 4 states/2 bit, 0 offset  
Data Range: 0 to 3 Operational Range: same as data range  
Type: Status  
Supporting information:  
PGN 64914

---

### **PGN 61444 (R) Electronic Engine Controller 1**

**- EEC1**

Engine related parameters.

Transmission Repetition Rate: engine speed dependent  
Data Length: 8  
Extended Data Page: 0  
Data Page: 0  
PDU Format: 240  
PDU Specific: 4 PGN Supporting Information:  
Default Priority: 3  
Parameter Group Number: 61444 (0xF004)

Start Position	Length	Parameter Name	SPN
1.1	4 bits	Engine Torque Mode	899
1.5	4 bits	Actual Engine - Percent Torque High Resolution	4154
2	1 byte	Driver's Demand Engine - Percent Torque	512
3	1 byte	Actual Engine - Percent Torque	513
<b>4-5</b>	<b>2 bytes</b>	<b>Engine Speed</b>	<b>190</b>
6	1 byte	Source Address of Controlling Device for Engine Control	1483
7.1	4 bits	Engine Starter Mode	1675
8	1 byte	Engine Demand – Percent Torque	2432

---

**PGN 61450 Engine Gas Flow Rate****- EGF1**

Flow rates of Air and mixed gasses into the engine cylinders.

Transmission Repetition Rate: 50 ms  
 Data Length: 8  
 Extended Data Page: 0  
 Data Page: 0  
 PDU Format: 240  
 PDU Specific: 10 PGN Supporting Information:  
 Default Priority: 3  
 Parameter Group Number: 61450 (0xF00A)

Start Position	Length	Parameter Name	SPN
1-2	2 bytes	Engine Exhaust Gas Recirculation (EGR) Mass Flow Rate	2659
<b>3-4</b>	<b>2 bytes</b>	<b>Engine Inlet Air Mass Flow Rate</b>	<b>132</b>

**PGN 64914 Engine Operating Information****- EOI**

Contains engine parameters related to operation.

Transmission Repetition Rate: 250 ms  
 Data Length: 8  
 Extended Data Page: 0  
 Data Page: 0  
 PDU Format: 253  
 PDU Specific: 146 PGN Supporting Information:  
 Default Priority: 3  
 Parameter Group Number: 64914 (0xFD92)

Start Position	Length	Parameter Name	SPN
1.1	4 bits	Engine Operating State	3543
<b>1.5</b>	<b>2 bits</b>	<b>Fuel Pump Primer Control</b>	<b>4082</b>
2-3	2 bytes	Time Remaining in Engine Operating State	3544
4.1	2 bits	Engine Fuel Shutoff Vent Control	3608
4.3	2 bits	Engine Fuel Shutoff 1 Control	632
4.5	2 bits	Engine Fuel Shutoff 2 Control	2807
4.7	2 bits	Engine Fuel Shutoff Valve Leak Test Control	3601
5.1	2 bits	Engine Oil Priming Pump Control	3589
5.3	2 bits	Engine Oil Pre-heater Control	3602
5.5	2 bits	Engine Electrical System Power Conservation Control	3603
5.7	2 bits	Engine Block / Coolant Pre-heater Control	3604
6.1	2 bits	Engine Coolant Circulating Pump Control	3605
6.3	2 bits	Engine Controlled Shutdown Request	3606
6.5	2 bits	Engine Emergency (Immediate) Shutdown Indication	3607
8	1 byte	Engine Derate Request	3644



**PGN 65153 Fuel Information 2 (Gaseous)****- GF12**

Gaseous fuel information 2.

Transmission Repetition Rate: On request  
 Data Length: 8  
 Extended Data Page: 0  
 Data Page: 0  
 PDU Format: 254  
 PDU Specific: 129 PGN Supporting Information:  
 Default Priority: 7  
 Parameter Group Number: 65153 (0xFE81)

Start Position	Length	Parameter Name	SPN
1-2	2 bytes	Engine Fuel Flow Rate 1	1440
3-4	2 bytes	Engine Fuel Flow Rate 2	1441
<b>5</b>	<b>1 byte</b>	<b>Engine Fuel Valve 1 Position</b>	<b>1442</b>
6	1 byte	Engine Fuel Valve 2 Position	1443
<b>7</b>	<b>1 byte</b>	<b>Engine Requested Fuel Valve 1 Position</b>	<b>1765</b>
8	1 byte	Engine Requested Fuel Valve 2 Position	1766

**PGN 65243 Engine Fluid Level/Pressure 2****- EFL/P2**

Transmission Repetition Rate: 0.5 s  
 Data Length: 8  
 Extended Data Page: 0  
 Data Page: 0  
 PDU Format: 254  
 PDU Specific: 219 PGN Supporting Information:  
 Default Priority: 6  
 Parameter Group Number: 65243 (0xFEDB)

Start Position	Length	Parameter Name	SPN
<b>1-2</b>	<b>2 bytes</b>	<b>Engine Injection Control Pressure</b>	<b>164</b>
3-4	2 bytes	Engine Injector Metering Rail 1 Pressure	157
5-6	2 bytes	Engine Injector Timing Rail 1 Pressure	156
7-8	2 bytes	Engine Injector Metering Rail 2 Pressure	1349

**PGN 65263 Engine Fluid Level/Pressure 1****- EFL/P1**

Transmission Repetition Rate: 0.5 s  
 Data Length: 8  
 Extended Data Page: 0  
 Data Page: 0  
 PDU Format: 254  
 PDU Specific: 239 PGN Supporting Information:  
 Default Priority: 6  
 Parameter Group Number: 65263 (0xFEEF)

Start Position	Length	Parameter Name	SPN
<b>1</b>	<b>1 byte</b>	<b>Engine Fuel Delivery Pressure</b>	<b>94</b>
2	1 byte	Engine Extended Crankcase Blow-by Pressure	22
3	1 byte	Engine Oil Level	98
4	1 byte	Engine Oil Pressure	100
5-6	2 bytes	Engine Crankcase Pressure	101

7	1 byte	Engine Coolant Pressure	109
8	1 byte	Engine Coolant Level	111

**PGN 65269 Ambient Conditions**

**- AMB**

Transmission Repetition Rate:	1 s	
Data Length:	8	
Extended Data Page:	0	
Data Page:	0	
PDU Format:	254	
PDU Specific:	245	PGN Supporting Information:
Default Priority:	6	
Parameter Group Number:	65269	(0xFEf5)

Start Position	Length	Parameter Name	SPN
1	1 byte	Barometric Pressure	108
2-3	2 bytes	Cab Interior Temperature	170
4-5	2 bytes	Ambient Air Temperature	171
<b>5</b>	<b>1 byte</b>	<b>Engine Air Inlet Temperature</b>	<b>172</b>
7-8	2 bytes	Road Surface Temperature	79

- Encendido eléctrico motor

**SPN 1675 Engine Starter Mode**

There are several phases in a starting action and different reasons why a start cannot take place.

- 0000 start not requested
- 0001 starter active, gear not engaged
- 0010 starter active, gear engaged
- 0011 start finished; starter not active after having been actively engaged (after 50ms mode goes to 0000)
- 0100 starter inhibited due to engine already running
- 0101 starter inhibited due to engine not ready for start (preheating)
- 0110 starter inhibited due to driveline engaged or other transmission inhibit
- 0111 starter inhibited due to active immobilizer
- 1000 starter inhibited due to starter over-temp
- 1001-1011 Reserved
- 1100 starter inhibited - reason unknown
- 1101 error (legacy implementation only, use 1110)
- 1110 error
- 1111 not available

Data Length:	4 bits	
Resolution:	16 states/4 bit, 0 offset	
Data Range:	0 to 15	Operational Range: same as data range
Type:	Status	
Supporting information:		
PGN	61444	

Engine related parameters.

Transmission Repetition Rate:	engine speed dependent	
Data Length:	8	
Extended Data Page:	0	
Data Page:	0	
PDU Format:	240	
PDU Specific:	4	PGN Supporting Information:
Default Priority:	3	
Parameter Group Number:	61444	(0xF004)

Start Position	Length	Parameter Name	SPN
1.1	4 bits	Engine Torque Mode	899
1.5	4 bits	Actual Engine - Percent Torque High Resolution	4 154
2	1 byte	Driver's Demand Engine - Percent Torque	512
3	1 byte	Actual Engine - Percent Torque	513
<b>4-5</b>	<b>2 bytes</b>	<b>Engine Speed</b>	<b>190</b>
6	1 byte	Source Address of Controlling Device for Engine Control	1 483
<b>7</b>	<b>4 bits</b>	<b>Engine Starter Mode</b>	<b>1 675</b>
8	1 byte	Engine Demand – Percent Torque	2 432

- Sonda lambda

**SPN 3216 Aftertreatment 1 Intake NOx**

The amount of combined NO and NO2 in the exhaust entering the aftertreatment system measured by a NOx sensor at the aftertreatment intake, represented in NOx molecule parts per million non-NOx molecules in exhaust bank 1.

Data Length:	2 bytes	
Resolution:	0.05 ppm/bit, -200 ppm offset	
Data Range:	-200 to 3012.75 ppm	Operational Range: same as data range
Type:	Measured	
Supporting information:		
PGN	61454	

**SPN 3217 (R) Aftertreatment 1 Intake %O2**

The actual oxidation factor (%O2) of the gas within the exhaust stream. For positive values, the parameter represents the percent oxygen in excess of the amount required for stoichiometric combustion. For negative values, the parameter is proportional to the amount of oxygen being pumped by the sensor. This value is measured by a sensor at the aftertreatment intake in exhaust bank 1. A value of -12% (0x0000) indicates rich, a value of 21% (0xFAFF) indicates lean. These data points could optionally be used with switching O2 sensors to indicate those states as alternatives to broadcasting the threshold %O2 values. Diagnostic Tools could change display to use the text "Rich" or "Lean" in place of the implied %O2 values which would also be acceptable for display.

Data Length:	2 bytes	
Resolution:	0.000514 %/bit, -12 % offset	
Data Range:	-12% to 21%	Operational Range: same as data range
Type:	Measured	
Supporting information:		
PGN	61454	

### **SPN 3216 Aftertreatment 1 Outlet NOx**

The amount of combined NO and NO<sub>2</sub> in the exhaust entering the aftertreatment system measured by a NO<sub>x</sub> sensor at the aftertreatment intake, represented in NO<sub>x</sub> molecule parts per million non-NO<sub>x</sub> molecules in exhaust bank 1.

Data Length: 2 bytes  
Resolution: 0.05 ppm/bit, -200 ppm offset  
Data Range: -200 to 3012.75 ppm                      Operational Range: same as data range  
Type: Measured  
Supporting information:  
PGN 61455

---

### **SPN 3227 (R) Aftertreatment 1 Outlet %O<sub>2</sub>**

The actual oxidation factor (%O<sub>2</sub>) of the gas within the exhaust stream. For positive values, the parameter represents the percent oxygen in excess of the amount required for stoichiometric combustion. For negative values, the parameter is proportional to the amount of oxygen being pumped by the sensor. This value is measured by a sensor at the aftertreatment intake in exhaust bank 1.

A value of -12% (0x0000) indicates rich, a value of 21% (0xFAFF) indicates lean. These data points could optionally be used with switching O<sub>2</sub> sensors to indicate those states as alternatives to broadcasting the threshold %O<sub>2</sub> values. Diagnostic Tools could change display to use the text "Rich" or "Lean" in place of the implied %O<sub>2</sub> values which would also be acceptable for display.

Data Length: 2 bytes  
Resolution: 0.000514 %/bit, -12 % offset  
Data Range: -12% to 21%                      Operational Range: same as data range  
Type: Measured  
Supporting information:  
PGN 61455

---

### **PGN 61454 Aftertreatment 1 Intake Gas 1**

**- AT1IG1**

The purpose of this PGN is to group the aftertreatment intake sensor data for bank 1. These values include the NO<sub>x</sub>, %O<sub>2</sub>... Status's of the sensors with respect to the power being supplied and the heating element, errors and stability of the readings.

Transmission Repetition Rate: 50 ms  
Data Length: 8  
Extended Data Page: 0  
Data Page: 0  
PDU Format: 240  
PDU Specific: 14                      PGN Supporting Information:  
Default Priority: 6  
Parameter Group Number: 61454                      (0xF00E)

Start Position	Length	Parameter Name	SPN
1-2	2 bytes	Aftertreatment 1 Intake NO <sub>x</sub>	3216
3-4	2 bytes	Aftertreatment 1 Intake %O <sub>2</sub>	3217
5.1	2 bits	Aftertreatment 1 Intake Gas Sensor Power in Range	3218
5.3	2 bits	Aftertreatment 1 Intake Gas Sensor at Temperature	3219

5.5	2 bits	Aftertreatment 1 Intake NOx Reading Stable	3220
5.7	2 bits	Aftertreatment 1 Intake Wide-Range % O2 Reading Stable	3221
6.1	5 bits	Aftertreatment 1 Intake Gas Sensor Heater Preliminary FMI	3222
6.6	2 bits	Aftertreatment 1 Intake Gas Sensor Heater Control	3223
7.1	5 bits	Aftertreatment 1 Intake NOx Sensor Preliminary FMI	3224
8.1	5 bits	Aftertreatment 1 Intake Oxygen Sensor Preliminary FMI	3225

**PGN 61455 Aftertreatment 1 Outlet Gas 1**

**- AT10G1**

The purpose of this PGN is to group the aftertreatment outlet sensor data for bank 1. These values include the NOx, %O2, Status's of the sensors with respect to the power being supplied and the heating element, errors and stability of the readings.

Transmission Repetition Rate:	50 ms	
Data Length:	8	
Extended Data Page:	0	
Data Page:	0	
PDU Format:	240	
PDU Specific:	15	PGN Supporting Information:
Default Priority:	6	
Parameter Group Number:	61455	(0xF00F)

Start Position	Length	Parameter Name	SPN
<b>1-2</b>	<b>2 bytes</b>	<b>Aftertreatment 1 Outlet NOx</b>	<b>3226</b>
<b>3-4</b>	<b>2 bytes</b>	<b>Aftertreatment 1 Outlet %O2</b>	<b>3227</b>
5.1	2 bits	Aftertreatment 1 Outlet Gas Sensor Power in Range	3228
5.3	2 bits	Aftertreatment 1 Outlet Gas Sensor at Temperature	3229
5.5	2 bits	Aftertreatment 1 Outlet NOx Reading Stable	3230
5.7	2 bits	Aftertreatment 1 Outlet Wide-Range %O2 Reading Stable	3231
6.1	5 bits	Aftertreatment 1 Outlet Gas Sensor Heater Preliminary FMI	3232
6.6	2 bits	Aftertreatment 1 Outlet Gas Sensor Heater Control	3233
7.1	5 bits	Aftertreatment 1 Outlet NOx Sensor Preliminary FMI	3234
8.1	5 bits	Aftertreatment 1 Outlet Oxygen Sensor Preliminary FMI	3235

- Dirección asistida

**SPN 1807 Steering Wheel Angle**

The main operator's steering wheel angle (on the steering column, not the actual wheel angle). The vehicle being steered to the left results in a positive steering wheel angle.

Data Length:	2 bytes	
Resolution:	1/1024 rad per bit, -31.374 rad offset	
Data Range:	-31.374 to +31.374 rad	Operational Range: same as data range
Type:	Measured	
Supporting information:		
PGN	61449	

### **SPN 1808 Yaw Rate**

Indicates the rotation about the vertical axis. A positive yaw rate signal results when the vehicle turns counter-clockwise.

Data Length: 2 bytes  
Resolution: 1/8192 rad/s per bit, -3.92 rad/s offset  
Data Range: -3.92 to +3.92 rad/s Operational Range: same as data range  
Type: Measured  
Supporting information:  
PGN 61449

---

### **SPN 1809 Lateral Acceleration**

Indicates a lateral acceleration of the vehicle. A positive lateral acceleration signal results when the vehicle is accelerated to the left.

Data Length: 2 bytes  
Resolution: 1/2048 m/s<sup>2</sup> per bit, -15.687 m/s<sup>2</sup> offset  
Data Range: -15.687 to +15.687 m/s<sup>2</sup> Operational Range: same as data range  
Type: Measured  
Supporting information:  
PGN 61449

---

### **SPN 1810 Longitudinal Acceleration**

Indicates the longitudinal acceleration of the vehicle. A positive longitudinal acceleration signal results when the vehicle speed increases, regardless of driving the vehicle forward or backward.

Data Length: 1 byte  
Resolution: 0.1 m/s<sup>2</sup> per bit, -12.5 m/s<sup>2</sup> offset  
Data Range: -12.5 to +12.5 m/s<sup>2</sup> Operational Range: same as data range  
Type: Measured  
Supporting information:  
PGN 61449

---

### **PGN 61449 Vehicle Dynamic Stability Control 2**

**- VDC2**

Contains information which relates to the vehicle's movement.

Transmission Repetition Rate: 10 ms  
Data Length: 8  
Extended Data Page: 0  
Data Page: 0  
PDU Format: 240  
PDU Specific: 9 PGN Supporting Information:  
Default Priority: 6  
Parameter Group Number: 61449 (0xF009)

Start Position	Length	Parameter Name	SPN
1-2	2 bytes	<b>Steering Wheel Angle</b>	<b>1807</b>
3.1	6 bits	Steering Wheel Turn Counter	1811

3-7	2 bits	Steering Wheel Angle Sensor Type	1812
<b>4-5</b>	<b>2 bytes</b>	<b>Yaw Rate</b>	<b>1808</b>
<b>6-7</b>	<b>2 bytes</b>	<b>Lateral Acceleration</b>	<b>1809</b>
<b>8</b>	<b>1 byte</b>	<b>Longitudinal Acceleration</b>	<b>1810</b>

- Ayudas a la conducción (ABS, BAS, ASR, ESP)

### **SPN 521 Brake Pedal Position**

Ratio of brake pedal position to maximum pedal position. Used for electric brake applications. 0% means no braking. Also when there are two brake pedals on the machine the maximum of the two should be transmitted for Brake Pedal Position.

Data Length: 1 byte  
Resolution: 0.4 %/bit, 0 offset  
Data Range: 0 to 100 % Operational Range: same as data range  
Type: Measured  
Supporting information:  
PGN 61441

### **SPN 561 ASR Engine Control Active**

State signal which indicates that ASR engine control has been commanded to be active. Active means that ASR actually tries to control the engine. This state signal is independent of other control commands to the engine (e.g., from the transmission) which may have higher priority.

- 00 - ASR engine control passive but installed
- 01 - ASR engine control active
- 10 - Reserved
- 11 - Not available

Data Length: 2 bits  
Resolution: 4 states/2 bit, 0 offset  
Data Range: 0 to 3 Operational Range: same as data range  
Type: Status  
Supporting information:  
PGN 61441

### **SPN 562 ASR Brake Control Active**

State signal which indicates that ASR brake control is active. Active means that ASR actually controls wheel brake pressure at one or more wheels of the driven axle(s).

- 00 - ASR brake control passive but installed
- 01 - ASR brake control active
- 10 - Reserved
- 11 - Not available

Data Length: 2 bits  
Resolution: 4 states/2 bit, 0 offset  
Data Range: 0 to 3 Operational Range: same as data range  
Type: Status  
Supporting information: PGN 61441

### ***SPN 563 Anti-Lock Braking (ABS) Active***

State signal which indicates that the ABS is active. The signal is set active when wheel brake pressure actually starts to be modulated by ABS and is reset to passive when all wheels are in a stable condition for a certain time. The signal can also be set active when driven wheels are in high slip (e.g., caused by retarder). Whenever the ABS system is not fully operational (due to a defect or during off-road ABS operation), this signal is only valid for that part of the system that is still working. When ABS is switched off completely, the flag is set to passive regardless of the current wheel slip conditions.

00 - ABS passive but installed  
01 - ABS active  
10 - Reserved  
11 - Not available

Data Length: 2 bits  
Resolution: 4 states/2 bit, 0 offset  
Data Range: 0 to 3  
Type: Status  
Supporting information:  
PGN 61441

Operational Range: same as data range

---

### ***SPN 1091 Brake Application Pressure High Range, Front Axle, Left Wheel***

The brake application pressure for the left wheel on the front axle.

Data Length: 1 byte  
Resolution: 5 kPa/bit, 0 offset  
Data Range: 0 to 1,250 kPa  
Type: Measured  
Supporting information:  
PGN 65197

Operational Range: same as data range

---

### ***SPN 1092 Brake Application Pressure High Range, Front Axle, Right Wheel***

The brake application pressure for the right wheel on the front axle.

Data Length: 1 byte  
Resolution: 5 kPa/bit, 0 offset  
Data Range: 0 to 1,250 kPa  
Type: Measured  
Supporting information:  
PGN 65197

Operational Range: same as data range



### ***SPN 1093 Brake Application Pressure High Range, Rear Axle #1, Left Wheel***

The brake application pressure for the left wheel on the rear axle #1.

Data Length: 1 byte  
Resolution: 5 kPa/bit, 0 offset  
Data Range: 0 to 1,250 kPa                      Operational Range: same as data range  
Type: Measured  
Supporting information:  
PGN 65197

---

### ***SPN 1094 Brake Application Pressure High Range, Rear Axle #1, Right Wheel***

The brake application pressure for the right wheel on the rear axle #1.

Data Length: 1 byte  
Resolution: 5 kPa/bit, 0 offset  
Data Range: 0 to 1,250 kPa                      Operational Range: same as data range  
Type: Measured  
Supporting information:  
PGN 65197

---

### ***SPN 1592 Front Axle, Left Wheel Speed***

High resolution measurement of the speed of the left wheel on the front axle.

Data Length: 2 bytes  
Resolution: 1/256 km/h per bit, 0 offset  
Data Range: 0 to 250.996 km/h                      Operational Range: same as data range  
Type: Measured  
Supporting information:  
PGN 65134

---

### ***SPN 1593 Front axle, right wheel speed***

High resolution measurement of the speed of the right wheel on the front axle.

Data Length: 2 bytes  
Resolution: 1/256 km/h per bit, 0 offset  
Data Range: 0 to 250.996 km/h                      Operational Range: same as data range  
Type: Measured  
Supporting information:  
PGN 65134

---

### ***SPN 1594 Rear axle, left wheel speed***

High resolution measurement of the speed of the left wheel on the rear axle.

Data Length: 2 bytes  
Resolution: 1/256 km/h per bit, 0 offset  
Data Range: 0 to 250.996 km/h Operational Range: same as data range  
Type: Measured  
Supporting information:  
PGN 65134

---

### ***SPN 1595 Rear axle, right wheel speed***

High resolution measurement of the speed of the right wheel on the rear axle.

Data Length: 2 bytes  
Resolution: 1/256 km/h per bit, 0 offset  
Data Range: 0 to 250.996 km/h Operational Range: same as data range  
Type: Measured  
Supporting information:  
PGN 65134

---

### ***SPN 1807 Steering Wheel Angle***

The main operator's steering wheel angle (on the steering column, not the actual wheel angle). The vehicle being steered to the left results in a positive steering wheel angle.

Data Length: 2 bytes  
Resolution: 1/1024 rad per bit, -31.374 rad offset  
Data Range: -31.374 to +31.374 rad Operational Range: same as data range  
Type: Measured  
Supporting information:  
PGN 61449

---

### ***SPN 1809 Lateral Acceleration***

Indicates a lateral acceleration of the vehicle. A positive lateral acceleration signal results when the vehicle is accelerated to the left.

Data Length: 2 bytes  
Resolution: 1/2048 m/s<sup>2</sup> per bit, -15.687 m/s<sup>2</sup> offset  
Data Range: -15.687 to +15.687 m/s<sup>2</sup> Operational Range: same as data range  
Type: Measured  
Supporting information:  
PGN 61449

---

### **SPN 1810 Longitudinal Acceleration**

Indicates the longitudinal acceleration of the vehicle. A positive longitudinal acceleration signal results when the vehicle speed increases, regardless of driving the vehicle forward or backward.

Data Length: 1 byte  
Resolution: 0.1 m/s<sup>2</sup> per bit, -12.5 m/s<sup>2</sup> offset  
Data Range: -12.5 to +12.5 m/s<sup>2</sup> Operational Range: same as data range  
Type: Measured  
Supporting information:  
PGN 61449

---

### **PGN 61441 Electronic Brake Controller 1**

**- EBC1**

Used for brake control information.

Transmission Repetition Rate: 100 ms  
Data Length: 8  
Extended Data Page: 0  
Data Page: 0  
PDU Format: 240  
PDU Specific: 1 PGN Supporting Information:  
Default Priority: 6  
Parameter Group Number: 61441 (0xF001)

Start Position	Length	Parameter Name	SPN
1.1	2 bits	<b>ASR Engine Control Active</b>	<b>561</b>
1.3	2 bits	<b>ASR Brake Control Active</b>	<b>562</b>
1.5	2 bits	<b>Anti-Lock Braking (ABS) Active</b>	<b>563</b>
1.7	2 bits	EBS Brake Switch	1121
2	1 byte	<b>Brake Pedal Position</b>	<b>521</b>
3.1	2 bits	ABS Off-road Switch	575
3.3	2 bits	ASR Off-road Switch	576
3.5	2 bits	ASR "Hill Holder" Switch	577
3.7	2 bits	Traction Control Override Switch	1238
4.1	2 bits	Accelerator Interlock Switch	972
4.3	2 bits	Engine Derate Switch	971
4.5	2 bits	Engine Auxiliary Shutdown Switch	970
4.7	2 bits	Remote Accelerator Enable Switch	969
5	1 byte	Engine Retarder Selection	973
6.1	2 bits	ABS Fully Operational	1243
6.3	2 bits	EBS Red Warning Signal	1439
6.5	2 bits	ABS/EBS Amber Warning Signal (Powered Vehicle)	1438
6.7	2 bits	ATC/ASR Information Signal	1793
7	1 byte	Source Address of Controlling Device for Brake Control	1481
8.3	2 bits	Halt brake switch	2911
8.5	2 bits	Trailer ABS Status	1836
8.7	2 bits	Tractor-Mounted Trailer ABS Warning Signal	1792

---

**PGN 61449 Vehicle Dynamic Stability Control 2**

**- VDC2**

Contains information which relates to the vehicle's movement.

Transmission Repetition Rate: 10 ms  
 Data Length: 8  
 Extended Data Page: 0  
 Data Page: 0  
 PDU Format: 240  
 PDU Specific: 9 PGN Supporting Information:  
 Default Priority: 6  
 Parameter Group Number: 61449 (0xF009)

Start Position	Length	Parameter Name	SPN
1-2	2 bytes	<b>Steering Wheel Angle</b>	<b>1807</b>
3.1	6 bits	Steering Wheel Turn Counter	1811
3.7	2 bits	Steering Wheel Angle Sensor Type	1812
4-5	2 bytes	Yaw Rate	1808
6-7	2 bytes	<b>Lateral Acceleration</b>	<b>1809</b>
8	1 byte	<b>Longitudinal Acceleration</b>	<b>1810</b>

**PGN 65134 High Resolution Wheel Speed**

**- HRW**

Transmission Repetition Rate: 20 ms  
 Data Length: 8  
 Extended Data Page: 0  
 Data Page: 0  
 PDU Format: 254  
 PDU Specific: 110 PGN Supporting Information:  
 Default Priority: 2  
 Parameter Group Number: 65134 (0xFE6E)

Start Position	Length	Parameter Name	SPN
1-2	2 bytes	<b>Front Axle, Left Wheel Speed</b>	<b>1592</b>
3-4	2 bytes	<b>Front axle, right wheel speed</b>	<b>1593</b>
5-6	2 bytes	<b>Rear axle, left wheel speed</b>	<b>1594</b>
7-8	2 bytes	<b>Rear axle, right wheel speed</b>	<b>1595</b>

**PGN 65197 Wheel Application Pressure High Range Information**

**- EBC3**

Transmission Repetition Rate: 100 ms  
 Data Length: 8  
 Extended Data Page: 0  
 Data Page: 0  
 PDU Format: 254  
 PDU Specific: 173 PGN Supporting Information:  
 Default Priority: 6  
 Parameter Group Number: 65197 (0xFEAD)

Start Position	Length	Parameter Name	SPN
1	1 byte	<b>Brake Application Pressure High Range, Front Axle, Left Wheel</b>	<b>1091</b>
2	1 byte	<b>Brake Application Pressure High Range, Front Axle, Right Wheel</b>	<b>1092</b>
3	1 byte	<b>Brake Application Pressure High Range, Rear Axle #1, Left Wheel</b>	<b>1093</b>
4	1 byte	<b>Brake Application Pressure High Range, Rear Axle #1, Right Wheel</b>	<b>1094</b>

## 8.4 Comunicaciones en el bus del panel de mando

- Fecha/Hora

### **SPN 1604 Adjust minutes**

Part of the parameter used to set the time.

Data Length:	1 byte	
Resolution:	1 min/bit, 0 offset	
Data Range:	0 to 250 mins	Operational Range: 0 to 59 min
Type:	Measured	
Supporting information:		
PGN	54528	

---

### **SPN 1605 Adjust hours**

Part of the parameter used to set the time.

Data Length:	1 byte	
Resolution:	1 hr/bit, 0 offset	
Data Range:	0 to 250 hr	Operational Range: 0 to 23 h
Type:	Measured	
Supporting information:		
PGN	54528	

---

### **SPN 1606 Adjust month**

Part of a parameter used to set a calendar date.

NOTE - A value of 0 for the month is null. The value 1 identifies January; 2 identifies February; etc.

Data Length:	1 byte	
Resolution:	1 month/bit, 0 offset	
Data Range:	0 to 250 months	Operational Range: 1 to 12 month
Type:	Measured	
Supporting information:		
PGN	54528	

---

### **SPN 1607 Adjust day**

Part of a parameter used to set a calendar date.

NOTE - A value of 0 for the date is null. The values 1, 2, 3, and 4 are used to identify the first day of the month; 5, 6, 7, and 8 identify the second day of the month; etc.

Data Length:	1 byte	
Resolution:	0.25 days/bit, 0 offset	
Data Range:	0 to 62.5 days	Operational Range: 0.25 to 31.75 day
Type:	Measured	
Supporting information:		
PGN	54528	

### **SPN 1608 Adjust year**

Part of a parameter used to set a calendar date.

NOTE - A value of 0 for the year identifies the year 1985; a value of 1 identifies 1986; etc.

Data Length: 1 byte  
Resolution: 1 year/bit, 1985 years offset  
Data Range: 1985 to 2235 years  
Type: Measured  
Supporting information:  
PGN 54528

Operational Range: 1985 to 2235 year

---

### **PGN 54528 Time/Date Adjust**

**- TDA**

Transmission Repetition Rate: As needed  
Data Length: 8  
Extended Data Page: 0  
Data Page: 0  
PDU Format: 213  
PDU Specific: DA  
Default Priority: 6  
Parameter Group Number: 54528

PGN Supporting Information:  
(0xD500)

Start Position	Length	Parameter Name	SPN
1	1 byte	Adjust seconds	1603
2	1 byte	<b>Adjust minutes</b>	<b>1604</b>
3	1 byte	<b>Adjust hours</b>	<b>1605</b>
4	1 byte	<b>Adjust month</b>	<b>1606</b>
5	1 byte	<b>Adjust day</b>	<b>1607</b>
6	1 byte	<b>Adjust year</b>	<b>1608</b>
7	1 byte	Adjust local minute offset	1609
8	1 byte	Adjust local hour offset	1610

- Cuentakilómetros

### **SPN 244 Trip Distance**

Distance traveled during all or part of a journey.

Data Length: 4 bytes  
Resolution: 0.125 km/bit, 0 offset  
Data Range: 0 to 526,385,151.9 km  
Type: Measured  
Supporting information:  
PGN 65248

Operational Range: same as data range

---

### **SPN 245 Total Vehicle Distance**

Accumulated distance traveled by vehicle during its operation.

Data Length: 4 bytes  
Resolution: 0.125 km/bit, 0 offset  
Data Range: 0 to 526,385,151.9 km      Operational Range: same as data range  
Type: Measured  
Supporting information:  
PGN 65248

---

### **PGN 65248 Vehicle Distance**

**- VD**

Transmission Repetition Rate: 100 ms  
Data Length: 8  
Extended Data Page: 0  
Data Page: 0  
PDU Format: 254  
PDU Specific: 224      PGN Supporting Information:  
Default Priority: 6  
Parameter Group Number: 65248      (0xFEE0)

Start Position	Length	Parameter Name	SPN
1-4	4 bytes	<b>Trip Distance</b>	<b>244</b>
5-8	4 bytes	<b>Total Vehicle Distance</b>	<b>245</b>

- Indicador velocidad

### **SPN 84 Wheel-Based Vehicle Speed**

Speed of the vehicle as calculated from wheel or tailshaft speed.

Data Length: 2 bytes  
Resolution: 1/256 km/h per bit, 0 offset  
Data Range: 0 to 250.996 km/h      Operational Range: same as data range  
Type: Measured  
Supporting information:  
PGN 65265

---

### **PGN 65265 Cruise Control/Vehicle Speed**

**- CCVS**

Transmission Repetition Rate: 100 ms  
Data Length: 8  
Extended Data Page: 0  
Data Page: 0  
PDU Format: 254  
PDU Specific: 241      PGN Supporting Information:  
Default Priority: 6  
Parameter Group Number: 65265      (0xFEf1)

Start Position	Length	Parameter Name	SPN
2-3	2 bytes	<b>Wheel-Based Vehicle Speed</b>	<b>84</b>

- Cuentarrevoluciones

**SPN 190 Engine Speed**

Actual engine speed which is calculated over a minimum crankshaft angle of 720 degrees divided by the number of cylinders.

Data Length: 2 bytes  
 Resolution: 0.125 rpm/bit, 0 offset  
 Data Range: 0 to 8,031.875 rpm      Operational Range: same as data range  
 Type: Measured  
 Supporting information:  
 PGN 61444

**PGN 61444 (R) Electronic Engine Controller 1**

**- EEC1**

Engine related parameters

Transmission Repetition Rate: engine speed dependent  
 Data Length: 8  
 Extended Data Page: 0  
 Data Page: 0  
 PDU Format: 240  
 PDU Specific: 4      PGN Supporting Information:  
 Default Priority: 3  
 Parameter Group Number: 61444      (0xF004)

Start Position	Length	Parameter Name	SPN
1.1	4 bits	Engine Torque Mode	899
1.5	4 bits	Actual Engine - Percent Torque High Resolution	4 154
2	1 byte	Driver's Demand Engine - Percent Torque	512
3	1 byte	Actual Engine - Percent Torque	513
<b>4-5</b>	<b>2 bytes</b>	<b>Engine Speed</b>	<b>190</b>
6	1 byte	Source Address of Controlling Device for Engine Control	1 483
7.	4 bits	Engine Starter Mode	1 675
8	1 byte	Engine Demand – Percent Torque	2 432

- Nivel Gasolina

**SPN 96 (R) Fuel Level 1**

Ratio of volume of fuel to the total volume of fuel storage container. When Fuel Level 2 (SPN 38) is not used, Fuel Level 1 represents the total fuel in all fuel storage containers. When Fuel Level 2 is used, Fuel Level 1 represents the fuel level in the primary or left-side fuel storage container.

Data Length: 1 byte  
 Resolution: 0.4 %/bit, 0 offset  
 Data Range: 0 to 100 %      Operational Range: same as data range  
 Type: Measured  
 Supporting information:  
 PGN 65276



**PGN 65276 (R) Dash Display**

- DD

Transmission Repetition Rate: 1s  
 Data Length: 8  
 Extended Data Page: 0  
 Data Page: 0  
 PDU Format: 254  
 PDU Specific: 252 PGN Supporting Information:  
 Default Priority: 6  
 Parameter Group Number: 65276 (0xFEFC)

Start Position	Length	Parameter Name	SPN
1	1 byte	Washer Fluid Level	80
<b>2</b>	<b>1 byte</b>	<b>Fuel Level 1</b>	<b>96</b>
3	1 byte	Engine Fuel Filter Differential Pressure	95
4	1 byte	Engine Oil Filter Differential Pressure	99
5-6	2 bytes	Cargo Ambient Temperature	169
7	1 byte	Fuel Level 2	38

- Medidor temperatura del líquido de refrigerante motor

**SPN 110 Engine Coolant Temperature**

Temperature of liquid found in engine cooling system.

Data Length: 1 byte  
 Resolution: 1 deg C/bit, -40 deg C offset  
 Data Range: -40 to 210 deg C Operational Range: same as data range  
 Type: Measured  
 Supporting information:  
 PGN 65262

**PGN 65262 Engine Temperature 1**

- ET1

Transmission Repetition Rate: 1 s  
 Data Length: 8  
 Extended Data Page: 0  
 Data Page: 0  
 PDU Format: 254  
 PDU Specific: 238 PGN Supporting Information:  
 Default Priority: 6  
 Parameter Group Number: 65262 (0xFEFE)

Start Position	Length	Parameter Name	SPN
<b>1</b>	<b>1 byte</b>	<b>Engine Coolant Temperature</b>	<b>110</b>
2	1 byte	Engine Fuel Temperature	1 174
3-4	2 bytes	Engine Oil Temperature	1 175
5-6	2 bytes	Engine Turbocharger Oil Temperature	176
7	1 byte	Engine Intercooler Temperature	52
8	1 byte	Engine Intercooler Thermostat Opening	1 134

- Presión aceite motor

### **SPN 98 Engine Oil Level**

Ratio of current volume of engine sump oil to maximum required volume.

Data Length: 1 byte  
 Resolution: 0.4 %/bit, 0 offset  
 Data Range: 0 to 100 % Operational Range: same as data range  
 Type: Measured  
 Supporting information:  
 PGN 65263

---

### **SPN 100 Engine Oil Pressure**

Gage pressure of oil in engine lubrication system as provided by oil pump.

Data Length: 1 byte  
 Resolution: 4 kPa/bit, 0 offset  
 Data Range: 0 to 1000 kPa Operational Range: same as data range  
 Type: Measured  
 Supporting information:  
 PGN 65263

---

### **PGN 65263 Engine Fluid Level/Pressure 1**

**- EFL/P1**

Transmission Repetition Rate: 0.5 s  
 Data Length: 8  
 Extended Data Page: 0  
 Data Page: 0  
 PDU Format: 254  
 PDU Specific: 239 PGN Supporting Information:  
 Default Priority: 6  
 Parameter Group Number: 65263 (0xFEEF)

Start Position	Length	Parameter Name	SPN
1	1 byte	Engine Fuel Delivery Pressure	94
2	1 byte	Engine Extended Crankcase Blow-by Pressure	22
<b>3</b>	<b>1 byte</b>	<b>Engine Oil Level</b>	<b>98</b>
<b>4</b>	<b>1 byte</b>	<b>Engine Oil Pressure</b>	<b>100</b>
5-6	2 bytes	Engine Crankcase Pressure	101
7	1 byte	Engine Coolant Pressure	109
8	1 byte	Engine Coolant Level	111

- Testigo Batería

**SPN 5021 Battery Charguer**

Indicator of state of charge of the main battery.

00 Con carga  
01 Sin carga  
10 Reservado  
11 Don't Care

Data Length:	2 bits	
Resolution:	4 states/2 bit, 0 offset	
Data Range:	0 to 3	Operational Range: same as data range
Type:	Status	
Supporting information:		
PGN	65287	

- Testigo autodiagnosis

**SPN 5022 Autodiagnosis Witness**

Flag indicating whether there is any fault on the type ODB.

00 De-activated  
01 Activated  
10 Reserved  
11 Don't Care

Data Length:	2 bits	
Resolution:	4 states/2 bit, 0 offset	
Data Range:	0 to 3	Operational Range: same as data range
Type:	Status	
Supporting information:		
PGN	65287	

- Testigos luces

**SPN 5023 Lights Witness**

It indicates what lights are actived in the car

Bit 1: (0) light 1 de-activated, (1) light 1 activated  
Bit 2: (0) light 2 de-activated, (1) light 2 activated  
Bit 3: (0) light 3 de-activated, (1) light 3 activated  
Bit 4: (0) light 4 de-activated, (1) light 4 activated  
Bit 5: (0) light 5 de-activated, (1) light 5 activated  
Bit 6: (0) light 6 de-activated, (1) light 6 activated

Data Length:	6 bit	
Resolution:	64 states/6 bit, 0 offset	
Data Range:	0 to 63	Operational Range: same as data range
Type:	Status	
Supporting information:		
PGN	65287	

**PGN 65287 Witnesses Panel**

**- WITP**

Witness related parameters

Transmission Repetition Rate:	100 ms	
Data Length:	8	
Extended Data Page:	0	
Data Page:	0	
PDU Format:	255	
PDU Specific:	7	PGN Supporting Information:
Default Priority:	6	
Parameter Group Number:	65287	(0xFF07)

Start Position	Length	Parameter Name	SPN
1.1	2 bits	Battery Charguer	5 021
1.3	2 bits	Autodiagnosis Witness	5 022
2.1	6 bits	Lights Witness	5 023

- Testigo freno de mano

**SPN 70 Parking Brake Switch**

- 00 - Parking brake not set
- 01 - Parking brake set
- 10 - Error
- 11 - Not available

Data Length:	2 bits	
Resolution:	4 states/2 bit, 0 offset	
Data Range:	0 to 3	Operational Range: same as data range
Type:	Measured	
Supporting information:		
PGN	65265	

**PGN 65265 Cruise Control/Vehicle Speed**

**- CCVS**

Transmission Repetition Rate:	100 ms	
Data Length:	8	
Extended Data Page:	0	
Data Page:	0	
PDU Format:	254	
PDU Specific:	241	PGN Supporting Information:
Default Priority:	6	
Parameter Group Number:	65265	(0xFEf1)

Start Position	Length	Parameter Name	SPN
1.3	2 bits	Parking Brake Switch	70

## 9. Sistema de autodiagnos

OBD (del inglés *On Board Diagnostics*) es el sistema que usan los automóviles actualmente para la verificación y el diagnóstico a bordo de los diferentes estados del motor y los demás dispositivos del vehículo. En los coches con origen americano se usa el OBD II, en el mercado europeo el EOBD y en Japón el JOBD, siendo prácticamente iguales pero con alguna pequeña diferencia entre ellos. Este sistema es el estándar equivalente del SAE J1939, utilizado en camiones o autobuses.

El funcionamiento de este sistema es similar al de una pequeña computadora a bordo del vehículo. Cuando el sistema detecta algún problema debido a una comunicación interrumpida o algún fallo en los sensores o actuadores lo comunica inmediatamente, mediante el encendido de un testigo en el panel de mando, en el caso de este vehículo el testigo de autodiagnos pertenece al bus del panel del volante. Por lo tanto el usuario no tiene más que conectar un escáner de OBD para saber cuál es el código del error y poder solucionar el problema.

Este sistema es compatible con varios protocolos de comunicaciones en el vehículo, entre ellos el que vamos a implementar a nuestro automóvil según la norma ISO 15765 (CAN bus 11 bit 500k, CAN bus 29 bit 500k, CAN bus 11 bit 250k, CAN bus 29 bit 25k).

Entre los protocolos que pueden ser usados destacan tres:

- ISO 9141: Usado por Chrysler, marcas europeas y marcas asiáticas. Es el que usa el Peugeot 106 y por tanto el usado en este proyecto.
- SAE J1850 VPW (modulación de ancho de pulso variable): Usado por General Motors.
- SAE J1850 PWM (modulación de ancho de pulso): Usado por el Grupo Ford.

Esta información es transmitida mediante el conector del OBD-II (Figura 38) que posee 16 terminales cuyo uso resumido es:

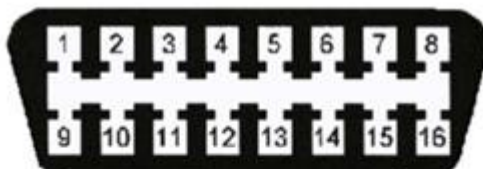

1 – Sin uso	9 – Sin uso
2 - J1850 Bus positivo	10 - J1850 Bus negativo
3 – Sin uso	11 – Sin uso
4 - Tierra del Vehículo	12 – Sin uso
5 – Tierra de la Señal	13 – Tierra de la señal
6 - CAN High	14 - CAN Low
7 - ISO 9141-2 - Línea K	15 - ISO 9141-2 - Línea L
8 – Sin uso	16 - Batería - positivo

**Figura 38:** Terminales del conector OBD II

Fuente: [http://e-auto.com.mx/manual\\_detalle.php?manual\\_id=119](http://e-auto.com.mx/manual_detalle.php?manual_id=119)

Este conector puede ser conectado con la computadora de diagnóstico mediante tecnología wifi, usb o bluetooth siendo cada vez menos usada la conexión RS232. Pudiendo incluso tener el diagnóstico en un *Smartphone* mediante aplicaciones del tipo “Torque”, “Dashcommand” o “Kiwi”.

La computadora nos dará una serie de códigos, en concreto uno por cada avería que haya sido detectada, que indicaran el tipo de avería que ha tenido lugar. Estos códigos están estandarizados en su mayor parte dejando también espacio para que cada fabricante incluya aquellos que crea conveniente. La forma de estos códigos es de una letra seguida de cuatro números, cuyo significado es el siguiente:

- El primer dígito indica:
  - Pxxxx para motor, transmisión y demás sistemas mecánicos.
  - Bxxxx para interior, ABS,...
  - Cxxxx para chasis, carrocería,...
  - Uxxxx para otros sistemas, bus de comunicaciones,...
  
- El segundo dígito indica:
  - P0xxx Códigos exigidos por la normativa ISO 9141
  - P1xxx Códigos adicionales de los fabricantes
  
- El tercer dígito indica:
  - Px1xx medición de aire y combustible
  - Px2xx medición de aire y combustible
  - Px3xx Sistema encendido
  - Px4xx Control emisiones adicional
  - Px5xx Velocidad y regulación ralenti
  - Px6xx ECU y señales de salida
  - Px7xx Transmisión
  - Px8xx Transmisión
  - Px9xx Módulos de control, señales de entrada y salida
  
- El cuarto y quinto dígito identifican componentes y sistemas individuales.

**Ejemplo:** Si al conectar el ordenador al vehículo nos sale el fallo P0130 cuya descripción es: *Sensor de oxígeno (banco 1, sensor 1) – voltaje alto*. Significa que el sensor de oxígeno de la sonda lambda está dando un voltaje más alto del esperado, debido a un problema del sensor o a que la concentración de oxígeno es demasiado alta en la mezcla. Las posibles causas de este fallo son o que el sensor de oxígeno está en cortocircuito o bien que el cableado del sensor está roto o desgastado. Para solucionar este fallo habría que reemplazar el sensor, comprobar si hay problemas de cableado o verificar el voltaje del sensor de oxígeno.

En el anexo de este trabajo se puede ver una lista de los principales códigos OBD que el vehículo Peugeot 106 posee, tanto los exigidos por la normativa ISO 9141 como los que Peugeot incluye en sus vehículos.

## 10. Presupuesto del proyecto

Para la elaboración del presupuesto se ha seguido siempre el criterio económico, ya que como se ha comentado anteriormente el automóvil a estudio pertenece a un segmento en el cual el precio final es uno de los factores más importantes así que, por lo general, se han comprado a los proveedores y las marcas que ofrecen el producto más económico y que se adecua a las exigencias del proyecto.

Muchas de las piezas o dispositivos no han podido ser encontradas en el mercado ordinario de proveedores de recambios automovilísticos por lo que se ha optado por comprar estas piezas de segunda mano, esto ha ocurrido sobre todo con las unidades de control del sistema de comunicaciones. Este hecho ha servido para bajar el precio final del presupuesto. Por otra parte debido a que no hay un único proveedor de las piezas y que muchas de ellas solo se han encontrado en proveedores que trabajan por internet al por menor, el precio de la mayoría de estas es bastante elevado por lo que el presupuesto final es mucho mayor que el que una empresa de fabricación de automóviles puede ofrecer a sus clientes en conjunto.

A continuación, se adjuntan (Tabla 13) todos los precios obtenidos de cada uno de los dispositivos ordenados por marcas.

**Tabla 13:** Presupuesto general del proyecto

Marca y Referencia	Descripción	Unidades	Precio unitario (IVA incluido) €	Total (IVA incluido) €
Airtex E10730M	Sensor nivel gasolina	1	59,95	59,95
Baldoms SEI-SEN06	Sensor par de giro dirección	1	65,00	65,00
Baytter 3B1 837 016 A	Sensor/cerradura puerta	2	31,95	63,9
Bosch 0 390 203 002	Motores asiento y ángulo adelante/atrás	2	64,95	129,90
Bosch 0 273 101 021	Sensor impacto frontal y lateral	2	103,67	207,74
Bosch 0 261 230 081	Sensor presión asiento pasajero	4	16,95	67,80
Bosch 0 280 156 173	Válvula inyección	1	82,95	82,95
Bosch 0 986 580 824	Bomba combustible	1	67,11	67,11
Bosch 0 280 120 334	Sensor posición mariposa	1	45,98	45,98
Bosch 0 281 002 399	Regulador presión	1	33,95	33,95
Bosch 0 986 020 290	Motor arranque	1	87,95	87,95
Bosch 0 265 005 624	Sensor aceleración transversal	1	69,31	69,31
Bosch 0 261 201 667	Unidad control motor (ECU)	1	179,28	179,28

Bosch 1K0 959 793 M + Vemo 6Q2 959 802 A	Unidad control puerta conductor y pasajero + motor elevallunas	2	117,95	235,90
FAE 12881	Sensor presión aceite	1	8,42	8,42
FAE 33784	Sensor temperatura agente frigorífico y refrigerante del motor	2	14,77	29,54
FAE 79177	Tacómetro electrónico motor	1	21,95	21,95
Febi Bilstein 32866	Interruptor pedal freno	1	7,64	7,64
Frigair 431 30130	Válvula reguladora compresor	1	21,95	21,95
Hella 1K0 959 433 BT	Unidad control confort	1	24,95	24,95
Honeywell SPX1189 002	Sensores infrarrojos cambio carril	4	15,99	63,96
Johns LMM 95 49-079	Sensor flujo aire MAF	1	53,95	53,95
Metzger 0900075	Sensor cuentarrevoluciones rueda delantera derecha	1	20,95	20,95
Metzger 0900074	Sensor cuentarrevoluciones rueda delantera izquierda	1	20,95	20,95
Metzger 0900055	Sensor cuentarrevoluciones ruedas traseras	2	22,95	45,90
Metzger 2190515	Motor limpiaparabrisas trasero	1	70,95	70,95
NRF 38935	Sensor de alta presión	1	19,24	19,24
Quinton Hazell XRLS123	Interruptor marcha atrás	1	8,80	8,80
Thermotec DDS003TT	Motor ventilador	1	77,98	77,98
TianGao BDL-ALS1	Sensor cantidad luz	1	56,38	56,38
Vemo 1K0 955 559	Sensor lluvia	1	26,16	26,16
Vemo 6Q1 955 119 A	Motor limpiaparabrisas delantero	1	72,95	72,95
Vemo 6Q0 951 221 H	Bocina	1	36,95	36,95
Vemo 5K0 959 772	Resistencias asientos térmicos	2	69,95	139,9
Vemo 1S0 919 275	Sensores proximidad objetos	8	59,95	479,6
Vemo 06B 905 379 A	Sensor temperatura aire	1	11,95	11,95



Vemo 013 542 77 17	Sensor fuerza pedal freno	1	142,95	142,95
Vemo 1K0 959 654	Sensor ángulo dirección volante	1	63,95	63,95
Vemo V10 72 0929 1	Sensor velocidad rotación transmisión	1	14,95	14,95
Vemo V10 72 1114	Sensor Tª exterior	1	11,95	11,95
Vemo V10 72 1204	Sensor Tª interior y salida del evaporador	1	13,95	13,95
Vemo V10 73 0167	Interruptores regulación asientos	2	26,71	53,42
Vemo V10 76 0090	Sensor control	1	85,95	85,95
Vemo V10 76 0071	Sensor diagnóstico	1	87,95	87,95
VDO X10 729 002 009	Motores cerradura puertas	3	16,95	50,85
VW 1J3 858 471 L	Sensores enganche cinturón	5	84,83	424,15
VW RNS 510	Unidad control radio/GPS	1	272,83	272,83
VW 6N0 962 257 A	Receptor señal mando y bomba	1	29,95	29,95
VW 1KD 959 613	Interruptor abrir/cerrar techo	1	15,00	15,00
VW 4B0 959 591	Motor abrir cerrar/techo	1	34,95	94,95
VW 4M0 486 020	Motor retrovisores	2	10,59	21,18
VW 6N0 422 155 E	Motor/Bomba dirección	1	13,78	13,78
VW 1K0 907 530 S	Interfaz para bus de datos (Gateway)	1	25,00	25,00
VW 1K0 953 549 A	Unidad control columna dirección	1	82,76	82,76
VW 8Z0 919 283 A	Unidad control asistencia aparcamiento	1	40,65	40,65
VW 4I0 907 568 A	Unidad control aviso cambio carril	1	75,00	75,00
VW 6Q0 909 601	Unidad control airbag	1	21,94	21,94
VW J 500	Unidad control servodirección	1	33,59	33,59
VW 1C0 907 379 J + VW 1J0 614 117 F	Unidad control ABS + Bomba/Válvulas control líquido frenos	1	100,00	100,00

VW 5K0 907 044 GR	Unidad control <i>climatic</i>	1	71,28	71,28
Microchip MCP2515-I/SO	Controlador CAN 2.0B, 18 pines	47	1,88	88,36
Microchip MCP2551-I/SN	Transceptor CAN 2.0B, 8 pines	47	1,06	49,82
Cervi 35100045	Cable Bus CAN 2X2X0.34 MM2.	100 (Metros)	0,46	46,00
<b>Total presupuesto (IVA incluido):</b>				<b>4 749,90 €</b>

Como se puede observar sale un presupuesto muy elevado, con respecto al que un vehículo de estas características posee en su sistema de comunicaciones con el mismo número de sistemas que el vehículo del estudio. Si fuera el propio fabricante quien fabricara o comprara todos los dispositivos a cada una de las marcas directamente sin la intervención de los proveedores intermedios el presupuesto final sería drásticamente más económico.

## 11. Bibliografía

- Rober Bosch GmbH. *Automotive Handbook*, 9ª edición.
- SAE J2284 *Vehicle Application Layer (High-speed)*
- SAE J2411 *Vehicle Application Layer (Low-speed)*
- SAE J1939-71 *Vehicle Application Layer Jan 2008*
- HDEI / BCEI Working Group. *FMS-Standard description*. Version 3. 2012
- Estándar ISO 11898-1. *Road vehicles -- Controller area network (CAN) -- Part 1: Data link layer and physical signaling*. 2006
- Estándar ISO 9141-2. *Vehículos de carretera. Sistemas de diagnosis. Parte 2: Requisitos CARB para el intercambio de información digital*. 2013
- *Manual de reparaciones Peugeot 106*. Einsa
- *Guía de utilización Peugeot 106*. Peugeot. ES. 01106.0051
- Microchip. *MCP2515 Data Sheet* (08/27/2012)
- Microchip. *MCP2561/2 Data Sheet* (07/14/2014)
- Cervi. *Cable Bus CAN especificaciones técnicas. Según norma DIN 19245 T3 y EN50170*
- Volkswagen Service. *Sistema de confort. Diseño y funcionamiento*. 193
- Volkswagen Service. *El CAN bus de datos. Diseño y funcionamiento*. 186
- Volkswagen Service *El intercambio de datos en el bus de datos CAN I*. 238
- Markus Junger. *Introduction to J1939 Version 1.1 2010-04-27 Application Note AN-ION-1-3100*.
- Autoxuga. *Códigos Averías OBD*. Disponible en:  
<http://www.autoxuga.com/cursos/Codigos/Codigos.htm>
- *Catálogo Bosch automóvil*. Disponible en:  
<http://www.bosch-automotive-catalog.com/es/product-search>
- *Catálogo VEMO*. Disponible en:  
<http://www.autoteile.de/es/>
- *Catálogo FAE*. Disponible en:  
<http://www.fae.es/es/catalogo>



# ANEXO I

Lista Códigos OBD

Código OBD	Código Avería	Código HEX	Interpretación de la Avería	Código OBD	Código Avería	Código HEX	Interpretación de la Avería
P0000	0	0000	NO SE ENCUENTRA NINGUNA AVERIA	P0045	69	0045	Solenoide sobrealimentación turbocompresor - circuito abierto
P0001	1	0001	Control regulador volumen combustible - circuito abierto	P0046	70	0046	Solenoide sobrealimentación turbocompresor - rango, rendimiento
P0002	2	0002	Control regulador volumen combustible - rango/funcionamiento circuito	P0047	71	0047	Solenoide sobrealimentación turbocompresor - señal baja
P0003	3	0003	Control regulador volumen combustible - señal baja	P0048	72	0048	Solenoide sobrealimentación turbocompresor - señal alta
P0004	4	0004	Control regulador volumen combustible - señal alta	P0049	73	0049	Turbina turbocompresor - sobre velocidad
P0005	5	0005	Válvula corte combustible - circuito abierto	P0050	80	0050	Sensor calentado oxígeno (Sensor 1 bloque 2) - circuito defectuoso
P0006	6	0006	Válvula corte combustible - señal baja	P0051	81	0051	Sensor calentado oxígeno (Sensor 1 bloque 2) - señal baja
P0007	7	0007	Válvula corte combustible - señal alta	P0052	82	0052	Sensor calentado oxígeno (Sensor 1 bloque 2) - señal alta
P0008	8	0008	Sistema posición motor (bloque 1) - rendimiento	P0053	83	0053	Sensor calentado oxígeno (Sensor 1 bloque 1) - resistencia
P0009	9	0009	Sistema posición motor (bloque 2) - rendimiento	P0054	84	0054	Sensor calentado oxígeno (Sensor 2 bloque 1) - resistencia
P0010	16	0010	Actuador posición árbol levas (bloque 1) - circuito defectuoso	P0055	85	0055	Sensor calentado oxígeno (Sensor 3 bloque 1) - resistencia
P0011	17	0011	Posición árbol levas (bloque 1) - encendido avanzado, rendimiento	P0056	86	0056	Sensor calentado oxígeno (Sensor 2 bloque 2) - circuito defectuoso
P0012	18	0012	Posición árbol levas (bloque 1) - encendido atrasado	P0057	87	0057	Sensor calentado oxígeno (Sensor 2 bloque 2) - señal baja
P0013	19	0013	Actuador posición árbol levas (bloque 1) - circuito defectuoso	P0058	88	0058	Sensor calentado oxígeno (Sensor 2 bloque 2) - señal alta
P0014	20	0014	Actuador posición árbol levas (bloque 1) - encendido avanzado, rendimiento	P0059	89	0059	Sensor calentado oxígeno (Sensor 1 bloque 2) - resistencia
P0015	21	0015	Actuador posición árbol levas (bloque 1) - encendido atrasado	P0060	96	0060	Sensor calentado oxígeno (Sensor 2 bloque 2) - resistencia
P0016	22	0016	Posición cigüeñal-arbol levas (bloque 1 sensor A) - correlación	P0061	97	0061	Sensor calentado oxígeno (Sensor 3 bloque 2) - resistencia
P0017	23	0017	Posición cigüeñal-arbol levas (bloque 1 sensor B) - correlación	P0062	98	0062	Sensor calentado oxígeno (Sensor 3 bloque 2) - circuito defectuoso
P0018	24	0018	Posición cigüeñal-arbol levas (bloque 2 sensor A) - correlación	P0063	99	0063	Sensor calentado oxígeno (Sensor 3 bloque 2) - señal baja
P0019	25	0019	Posición cigüeñal-arbol levas (bloque 2 sensor B) - correlación	P0064	100	0064	Sensor calentado oxígeno (Sensor 3 bloque 2) - señal alta
P0020	32	0020	Actuador posición árbol levas (bloque 2) - circuito defectuoso	P0065	101	0065	Inyector asistido por aire - rango, funcionamiento
P0021	33	0021	Posición árbol levas (bloque 2) - encendido avanzado, rendimiento	P0066	102	0066	Inyector asistido por aire - circuito defectuoso, señal baja
P0022	34	0022	Posición árbol levas (bloque 2) - encendido atrasado	P0067	103	0067	Inyector asistido por aire - señal alta
P0023	35	0023	Actuador posición árbol levas (bloque 2) - circuito defectuoso	P0068	104	0068	Correlación sensor MAP/sensor MAF/Posición mariposa
P0024	36	0024	Actuador posición árbol levas (bloque 2) - encendido avanzado, rendimiento	P0069	105	0069	Correlación sensor presión absoluta colector/sensor presión barométrica
P0025	37	0025	Actuador posición árbol levas (bloque 2) - encendido atrasado	P0070	112	0070	Sensor temperatura aire ambiente - circuito defectuoso
P0026	38	0026	Circuito solenoide control válvula admisión (bloque 1) - rango	P0071	113	0071	Sensor temperatura aire ambiente - rango, funcionamiento
P0027	39	0027	Circuito solenoide control válvula escape (bloque 1) - rango	P0072	114	0072	Sensor temperatura aire ambiente - señal baja
P0028	40	0028	Circuito solenoide control válvula admisión (bloque 2) - rango	P0073	115	0073	Sensor temperatura aire ambiente - señal alta
P0029	41	0029	Circuito solenoide control válvula escape (bloque 2) - rango	P0074	116	0074	Sensor temperatura aire ambiente - Interrupción intermitente
P0030	48	0030	Sensor calentado oxígeno (Sensor 1 bloque 1) - circuito defectuoso	P0075	117	0075	Solenoide control válvula admisión (bloque 1) - circuito defectuoso
P0031	49	0031	Sensor calentado oxígeno (Sensor 1 bloque 1) - señal baja	P0076	118	0076	Solenoide control válvula admisión (bloque 1) - señal baja
P0032	50	0032	Sensor calentado oxígeno (Sensor 1 bloque 1) - señal alta	P0077	119	0077	Solenoide control válvula admisión (bloque 1) - señal alta
P0033	51	0033	Válvula descarga turbocompresor - circuito defectuoso	P0078	120	0078	Solenoide control válvula escape (bloque 1) - circuito defectuoso
P0034	52	0034	Válvula descarga turbocompresor - señal baja	P0079	121	0079	Solenoide control válvula escape (bloque 1) - señal baja
P0035	53	0035	Válvula descarga turbocompresor - señal alta	P0080	128	0080	Solenoide control válvula escape (bloque 1) - señal alta
P0036	54	0036	Sensor calentado oxígeno (Sensor 2 bloque 1) - circuito defectuoso	P0081	129	0081	Solenoide control válvula admisión (bloque 2) - circuito defectuoso
P0037	55	0037	Sensor calentado oxígeno (Sensor 2 bloque 1) - señal baja	P0082	130	0082	Solenoide control válvula admisión (bloque 2) - señal baja
P0038	56	0038	Sensor calentado oxígeno (Sensor 2 bloque 1) - señal alta	P0083	131	0083	Solenoide control válvula admisión (bloque 2) - señal alta
P0039	57	0039	Válvula derivación turbocompresor - rango	P0084	132	0084	Solenoide control válvula escape (bloque 2) - circuito defectuoso
P0040	64	0040	Señales sensor oxígeno cambiadas (bloque 1 sensor 1 y bloque 2 sensor 1)	P0085	133	0085	Solenoide control válvula escape (bloque 2) - señal baja
P0041	65	0041	Señales sensor oxígeno cambiadas (bloque 1 sensor 2 y bloque 2 sensor 2)	P0086	134	0086	Solenoide control válvula escape (bloque 2) - señal alta
P0042	66	0042	Sensor calentado oxígeno (Sensor 3 bloque 1) - circuito defectuoso	P0087	135	0087	Rampa combustible/Presión sistema demasiado baja
P0043	67	0043	Sensor calentado oxígeno (Sensor 3 bloque 1) - señal baja	P0088	136	0088	Rampa combustible/Presión sistema demasiado alta
P0044	68	0044	Sensor calentado oxígeno (Sensor 3 bloque 1) - señal alta	P0089	137	0089	Regulador presión combustible 1 - funcionamiento
				P0090	144	0090	Solenoide dosificador combustible 1 - circuito abierto
				P0091	145	0091	Solenoide dosificador combustible 1 - cortocircuito a masa
				P0092	146	0092	Solenoide dosificador combustible 1 - cortocircuito a positivo

P0093	147	0093	Fuga en sistema combustible - fuga grande	P0143	323	0143	Sensor oxigeno (Sensor 3 bloque 1) - Baja Tensión
P0094	148	0094	Fuga en sistema combustible - fuga pequeña	P0144	324	0144	Sensor oxigeno (Sensor 3 bloque 1) - Alta Tensión
P0095	149	0095	Sensor temperatura aire admisión 2 - circuito defectuoso	P0145	325	0145	Sensor oxigeno (Sensor 3 bloque 1) - respuesta lenta
P0096	150	0096	Sensor temperatura aire admisión 2 - rango, funcionamiento	P0146	326	0146	Sensor oxigeno (Sensor 3 bloque 1) - actividad no detectada
P0097	151	0097	Sensor temperatura aire admisión 2 - señal baja	P0147	327	0147	Sensor calentado oxigeno (Sensor 3 bloque 1) - circuito defectuoso
P0098	152	0098	Sensor temperatura aire admisión 2 - señal alta	P0148	328	0148	Error alimentación combustible
P0099	153	0099	Sensor temperatura aire admisión 2 - circuito intermitente	P0149	329	0149	Error reglaje combustible
P0100	256	0100	Sensor masa/volumen aire - circuito defectuoso	P0150	336	0150	Sensor oxigeno (Sensor 1 bloque 2) - circuito defectuoso
P0101	257	0101	Sensor masa/volumen aire - rango, funcionamiento	P0151	337	0151	Sensor oxigeno (Sensor 1 bloque 2) - Baja Tensión
P0102	258	0102	Sensor masa/volumen aire - señal entrada baja	P0152	338	0152	Sensor oxigeno (Sensor 1 bloque 2) - Alta Tensión
P0103	259	0103	Sensor masa/volumen aire - señal entrada alta	P0153	339	0153	Sensor oxigeno (Sensor 1 bloque 2) - respuesta lenta
P0104	260	0104	Sensor masa/volumen aire - interrupción intermitente	P0154	340	0154	Sensor oxigeno (Sensor 1 bloque 2) - actividad no detectada
P0105	261	0105	Sensor presión absoluta colector/presión barométrica - circuito defectuoso	P0155	341	0155	Sensor calentado oxigeno (Sensor 1 bloque 2) - circuito defectuoso
P0106	262	0106	Sensor presión absoluta colector/presión barométrica - rango, funcionamiento	P0156	342	0156	Sensor oxigeno (Sensor 2 bloque 2) - circuito defectuoso
P0107	263	0107	Sensor presión absoluta colector/presión barométrica - señal entrada baja	P0157	343	0157	Sensor oxigeno (Sensor 2 bloque 2) - Baja Tensión
P0108	264	0108	Sensor presión absoluta colector/presión barométrica - señal entrada alta	P0158	344	0158	Sensor oxigeno (Sensor 2 bloque 2) - Alta Tensión
P0109	265	0109	Sensor presión absoluta colector/presión barométrica - interrupción intermitente	P0159	345	0159	Sensor oxigeno (Sensor 2 bloque 2) - respuesta lenta
P0110	272	0110	Sensor temperatura aire admisión - circuito defectuoso	P0160	352	0160	Sensor oxigeno (Sensor 2 bloque 2) - actividad no detectada
P0111	273	0111	Sensor temperatura aire admisión - rango, funcionamiento	P0161	353	0161	Sensor calentado oxigeno (Sensor 2 bloque 2) - circuito defectuoso
P0112	274	0112	Sensor temperatura aire admisión - señal entrada baja	P0162	354	0162	Sensor oxigeno (Sensor 3 bloque 2) - circuito defectuoso
P0113	275	0113	Sensor temperatura aire admisión - señal entrada alta	P0163	355	0163	Sensor oxigeno (Sensor 3 bloque 2) - Baja Tensión
P0114	276	0114	Sensor temperatura aire admisión - interrupción intermitente	P0164	356	0164	Sensor oxigeno (Sensor 3 bloque 2) - Alta Tensión
P0115	277	0115	Sensor temperatura refrigerante motor - circuito defectuoso	P0165	357	0165	Sensor oxigeno (Sensor 3 bloque 2) - respuesta lenta
P0116	278	0116	Sensor temperatura refrigerante motor - rango, funcionamiento	P0166	358	0166	Sensor oxigeno (Sensor 3 bloque 2) - actividad no detectada
P0117	279	0117	Sensor temperatura refrigerante motor - señal entrada baja	P0167	359	0167	Sensor calentado oxigeno (Sensor 3 bloque 2) - circuito defectuoso
P0118	280	0118	Sensor temperatura refrigerante motor - señal entrada alta	P0168	360	0168	Temperatura combustible demasiado alta
P0119	281	0119	Sensor temperatura refrigerante motor - interrupción intermitente	P0169	361	0169	Composición combustible incorrecta
P0120	288	0120	Sensor posición pedal acelerador A/Mariposa A - circuito defectuoso	P0170	368	0170	Regulación inyección (bloque 1) - circuito defectuoso
P0121	289	0121	Sensor posición pedal acelerador A/Mariposa A - rango, funcionamiento	P0171	369	0171	Regulación inyección (bloque 1) - demasiado pobre
P0122	290	0122	Sensor posición pedal acelerador A/Mariposa A - señal entrada baja	P0172	370	0172	Regulación inyección (bloque 1) - demasiado rico
P0123	291	0123	Sensor posición pedal acelerador A/Mariposa A - señal entrada alta	P0173	371	0173	Regulación inyección (bloque 2) - circuito defectuoso
P0124	292	0124	Sensor posición pedal acelerador A/Mariposa A - interrupción intermitente	P0174	372	0174	Regulación inyección (bloque 2) - demasiado pobre
P0125	293	0125	Temperatura refrigerante insuficiente para control combustible bucle cerrado	P0175	373	0175	Regulación inyección (bloque 2) - demasiado rico
P0126	294	0126	Temperatura refrigerante insuficiente para funcionamiento estable	P0176	374	0176	Sensor composición combustible - circuito defectuoso
P0127	295	0127	Temperatura aire admisión demasiado alta	P0177	375	0177	Sensor composición combustible - rango, funcionamiento
P0128	296	0128	Termostato refrigerante - circuito defectuoso	P0178	376	0178	Sensor composición combustible - señal entrada baja
P0129	297	0129	Presión barométrica demasiado baja	P0179	377	0179	Sensor composición combustible - señal entrada alta
P0130	304	0130	Sensor oxigeno (Sensor 1 bloque 1) - circuito defectuoso	P0180	384	0180	Sensor temperatura combustible A - circuito defectuoso
P0131	305	0131	Sensor oxigeno (Sensor 1 bloque 1) - Baja Tensión	P0181	385	0181	Sensor temperatura combustible A - rango, funcionamiento
P0132	306	0132	Sensor oxigeno (Sensor 1 bloque 1) - Alta Tensión	P0182	386	0182	Sensor temperatura combustible A - señal entrada baja
P0133	307	0133	Sensor oxigeno (Sensor 1 bloque 1) - respuesta lenta	P0183	387	0183	Sensor temperatura combustible A - señal entrada alta
P0134	308	0134	Sensor oxigeno (Sensor 1 bloque 1) - actividad no detectada	P0184	388	0184	Sensor temperatura combustible A - interrupción intermitente
P0135	309	0135	Sensor calentado oxigeno (Sensor 1 bloque 1) - circuito defectuoso	P0185	389	0185	Sensor temperatura combustible B - circuito defectuoso
P0136	310	0136	Sensor oxigeno (Sensor 2 bloque 1) - circuito defectuoso	P0186	390	0186	Sensor temperatura combustible B - rango, funcionamiento
P0137	311	0137	Sensor oxigeno (Sensor 2 bloque 1) - Baja Tensión	P0187	391	0187	Sensor temperatura combustible B - señal entrada baja
P0138	312	0138	Sensor oxigeno (Sensor 2 bloque 1) - Alta Tensión	P0188	392	0188	Sensor temperatura combustible B - señal entrada alta
P0139	313	0139	Sensor oxigeno (Sensor 2 bloque 1) - respuesta lenta	P0189	393	0189	Sensor temperatura combustible B - interrupción intermitente
P0140	320	0140	Sensor oxigeno (Sensor 2 bloque 1) - actividad no detectada	P0190	400	0190	Sensor presión rampa combustible - circuito defectuoso
P0141	321	0141	Sensor calentado oxigeno (Sensor 2 bloque 1) - circuito defectuoso	P0191	401	0191	Sensor presión rampa combustible - rango, funcionamiento
P0142	322	0142	Sensor oxigeno (Sensor 3 bloque 1) - circuito defectuoso	P0192	402	0192	Sensor presión rampa combustible - señal entrada baja
				P0193	403	0193	Sensor presión rampa combustible - señal entrada alta

P0194	404	0194	Sensor presión rampa combustible - interrupción intermitente	P0245	581	0245	Válvula descarga turbo A - señal baja
P0195	405	0195	Sensor temperatura aceite motor - circuito defectuoso	P0246	582	0246	Válvula descarga turbo A - señal alta
P0196	406	0196	Sensor temperatura aceite motor - rango, funcionamiento	P0247	583	0247	Válvula descarga turbo B - circuito defectuoso
P0197	407	0197	Sensor temperatura aceite motor - señal entrada baja	P0248	584	0248	Válvula descarga turbo B - rango, funcionamiento
P0198	408	0198	Sensor temperatura aceite motor - señal entrada alta	P0249	585	0249	Válvula descarga turbo B - señal baja
P0199	409	0199	Sensor temperatura aceite motor - interrupción intermitente	P0250	592	0250	Válvula descarga turbo B - señal alta
P0200	512	0200	Inyector - circuito defectuoso	P0251	593	0251	Bomba inyección A (árbol levas/rotor) - circuito defectuoso
P0201	513	0201	Inyector Cilindro 1 - circuito defectuoso	P0252	594	0252	Bomba inyección A (árbol levas/rotor) - rango, funcionamiento
P0202	514	0202	Inyector Cilindro 2 - circuito defectuoso	P0253	595	0253	Bomba inyección A (árbol levas/rotor) - señal baja
P0203	515	0203	Inyector Cilindro 3 - circuito defectuoso	P0254	596	0254	Bomba inyección A (árbol levas/rotor) - señal alta
P0204	516	0204	Inyector Cilindro 4 - circuito defectuoso	P0255	597	0255	Bomba inyección A (árbol levas/rotor) - interrupción intermitente
P0205	517	0205	Inyector Cilindro 5 - circuito defectuoso	P0256	598	0256	Bomba inyección B (árbol levas/rotor) - circuito defectuoso
P0206	518	0206	Inyector Cilindro 6 - circuito defectuoso	P0257	599	0257	Bomba inyección B (árbol levas/rotor) - rango, funcionamiento
P0207	519	0207	Inyector Cilindro 7 - circuito defectuoso	P0258	600	0258	Bomba inyección B (árbol levas/rotor) - señal baja
P0208	520	0208	Inyector Cilindro 8 - circuito defectuoso	P0259	601	0259	Bomba inyección B (árbol levas/rotor) - señal alta
P0209	521	0209	Inyector Cilindro 9 - circuito defectuoso	P0260	608	0260	Bomba inyección B (árbol levas/rotor) - interrupción intermitente
P0210	528	0210	Inyector Cilindro 10 - circuito defectuoso	P0261	609	0261	Inyector Cilindro 1 - señal baja
P0211	529	0211	Inyector Cilindro 11 - circuito defectuoso	P0262	610	0262	Inyector Cilindro 1 - señal alta
P0212	530	0212	Inyector Cilindro 12 - circuito defectuoso	P0263	611	0263	Cilindro 1 - fallo contribución/equilibrio
P0213	531	0213	Inyector arranque en frío 1 - circuito defectuoso	P0264	612	0264	Inyector Cilindro 2 - señal baja
P0214	532	0214	Inyector arranque en frío 2 - circuito defectuoso	P0265	613	0265	Inyector Cilindro 2 - señal alta
P0215	533	0215	Solenoide corte combustible - circuito defectuoso	P0266	614	0266	Cilindro 2 - fallo contribución/equilibrio
P0216	534	0216	Control reglaje inyección - circuito defectuoso	P0267	615	0267	Inyector Cilindro 3 - señal baja
P0217	535	0217	Sobrecalentamiento motor	P0268	616	0268	Inyector Cilindro 3 - señal alta
P0218	536	0218	Sobrecalentamiento transmisión	P0269	617	0269	Cilindro 3 - fallo contribución/equilibrio
P0219	537	0219	Sobre régimen motor	P0270	624	0270	Inyector Cilindro 4 - señal baja
P0220	544	0220	Sensor posición pedal acelerador B/Mariposa B - circuito defectuoso	P0271	625	0271	Inyector Cilindro 4 - señal alta
P0221	545	0221	Sensor posición pedal acelerador B/Mariposa B - rango, funcionamiento	P0272	626	0272	Cilindro 4 - fallo contribución/equilibrio
P0222	546	0222	Sensor posición pedal acelerador B/Mariposa B - señal entrada baja	P0273	627	0273	Inyector Cilindro 5 - señal baja
P0223	547	0223	Sensor posición pedal acelerador B/Mariposa B - señal entrada alta	P0274	628	0274	Inyector Cilindro 5 - señal alta
P0224	548	0224	Sensor posición pedal acelerador B/Mariposa B - interrupción intermitente	P0275	629	0275	Cilindro 5 - fallo contribución/equilibrio
P0225	549	0225	Sensor posición pedal acelerador C/Mariposa C - circuito defectuoso	P0276	630	0276	Inyector Cilindro 6 - señal baja
P0226	550	0226	Sensor posición pedal acelerador C/Mariposa C - rango, funcionamiento	P0277	631	0277	Inyector Cilindro 6 - señal alta
P0227	551	0227	Sensor posición pedal acelerador C/Mariposa C - señal entrada baja	P0278	632	0278	Cilindro 6 - fallo contribución/equilibrio
P0228	552	0228	Sensor posición pedal acelerador C/Mariposa C - señal entrada alta	P0279	633	0279	Inyector Cilindro 7 - señal baja
P0229	553	0229	Sensor posición pedal acelerador C/Mariposa C - interrupción intermitente	P0280	640	0280	Inyector Cilindro 7 - señal alta
P0230	560	0230	Relé bomba combustible principal - circuito defectuoso	P0281	641	0281	Cilindro 7 - fallo contribución/equilibrio
P0231	561	0231	Relé bomba combustible secundaria - señal baja	P0282	642	0282	Inyector Cilindro 8 - señal baja
P0232	562	0232	Relé bomba combustible secundaria - señal alta	P0283	643	0283	Inyector Cilindro 8 - señal alta
P0233	563	0233	Relé bomba combustible secundaria - interrupción intermitente	P0284	644	0284	Cilindro 8 - fallo contribución/equilibrio
P0234	564	0234	Sobrealimentación motor - límite excedido	P0285	645	0285	Inyector Cilindro 9 - señal baja
P0235	565	0235	Sobrealimentación motor turbocompresor - límite no alcanzado	P0286	646	0286	Inyector Cilindro 9 - señal alta
P0236	566	0236	Sensor presión absoluta colector A (turbo) - rango, funcionamiento	P0287	647	0287	Cilindro 9 - fallo contribución/equilibrio
P0237	567	0237	Sensor presión absoluta colector A (turbo) - señal baja	P0288	648	0288	Inyector Cilindro 10 - señal baja
P0238	568	0238	Sensor presión absoluta colector A (turbo) - señal alta	P0289	649	0289	Inyector Cilindro 10 - señal alta
P0239	569	0239	Sensor presión absoluta colector B (turbo) - circuito defectuoso	P0290	656	0290	Cilindro 10 - fallo contribución/equilibrio
P0240	576	0240	Sensor presión absoluta colector B (turbo) - rango, funcionamiento	P0291	657	0291	Inyector Cilindro 11 - señal baja
P0241	577	0241	Sensor presión absoluta colector B (turbo) - señal baja	P0292	658	0292	Inyector Cilindro 11 - señal alta
P0242	578	0242	Sensor presión absoluta colector B (turbo) - señal alta	P0293	659	0293	Cilindro 11 - fallo contribución/equilibrio
P0243	579	0243	Válvula descarga turbo A - circuito defectuoso	P0294	660	0294	Inyector Cilindro 12 - señal baja
P0244	580	0244	Válvula descarga turbo A - rango, funcionamiento	P0295	661	0295	Inyector Cilindro 12 - señal alta



P0296	662	0296	Cilindro 12 - fallo contribución/equilibrio	P0347	839	0347	Sensor posición árbol levas A (bloque 2) - señal entrada baja
P0297	663	0297	Sobrevelocidad del vehículo	P0348	840	0348	Sensor posición árbol levas A (bloque 2) - señal entrada alta
P0298	664	0298	Temperatura aceite motor demasiado alta	P0349	841	0349	Sensor posición árbol levas A (bloque 2) - interrupción intermitente
P0299	665	0299	Turbocompresor	P0350	848	0350	Bobina encendido Primaria/Secundaria - circuito defectuoso
P0300	768	0300	Uno o varios cilindros - falsa explosión detectada	P0351	849	0351	Bobina encendido A Primaria/Secundaria - circuito defectuoso
P0301	769	0301	Cilindro 1 - falsa explosión detectada	P0352	850	0352	Bobina encendido B Primaria/Secundaria - circuito defectuoso
P0302	770	0302	Cilindro 2 - falsa explosión detectada	P0353	851	0353	Bobina encendido C Primaria/Secundaria - circuito defectuoso
P0303	771	0303	Cilindro 3 - falsa explosión detectada	P0354	852	0354	Bobina encendido D Primaria/Secundaria - circuito defectuoso
P0304	772	0304	Cilindro 4 - falsa explosión detectada	P0355	853	0355	Bobina encendido E Primaria/Secundaria - circuito defectuoso
P0305	773	0305	Cilindro 5 - falsa explosión detectada	P0356	854	0356	Bobina encendido F Primaria/Secundaria - circuito defectuoso
P0306	774	0306	Cilindro 6 - falsa explosión detectada	P0357	855	0357	Bobina encendido G Primaria/Secundaria - circuito defectuoso
P0307	775	0307	Cilindro 7 - falsa explosión detectada	P0358	856	0358	Bobina encendido H Primaria/Secundaria - circuito defectuoso
P0308	776	0308	Cilindro 8 - falsa explosión detectada	P0359	857	0359	Bobina encendido I Primaria/Secundaria - circuito defectuoso
P0309	777	0309	Cilindro 9 - falsa explosión detectada	P0360	864	0360	Bobina encendido J Primaria/Secundaria - circuito defectuoso
P0310	784	0310	Cilindro 10 - falsa explosión detectada	P0361	865	0361	Bobina encendido K Primaria/Secundaria - circuito defectuoso
P0311	785	0311	Cilindro 11 - falsa explosión detectada	P0362	866	0362	Bobina encendido L Primaria/Secundaria - circuito defectuoso
P0312	786	0312	Cilindro 12 - falsa explosión detectada	P0363	867	0363	Falsa explosión detectada - cancelación alimentación combustible
P0313	787	0313	Falsa explosión detectada - nivel bajo combustible	P0365	869	0365	Sensor posición árbol levas B, bloque 1 - circuito defectuoso
P0314	788	0314	Falsa explosión en un solo cilindro	P0366	870	0366	Sensor posición árbol levas B, bloque 1 - rango, funcionamiento
P0315	789	0315	Sistema posición cigüeñal	P0367	871	0367	Sensor posición árbol levas B, bloque 1 - señal entrada baja
P0316	790	0316	Falsa explosión durante arranque motor	P0368	872	0368	Sensor posición árbol levas B, bloque 1 - señal entrada alta
P0317	791	0317	No encuentra hardware carretera desnivelada	P0369	873	0369	Sensor posición árbol levas B, bloque 1 - interrupción intermitente
P0318	792	0318	Sensor carretera desnivelada A - circuito defectuoso	P0370	880	0370	Referencia reglaje encendido, señal alta resolución A - defectuosa
P0319	793	0319	Sensor carretera desnivelada B - circuito defectuoso	P0371	881	0371	Referencia reglaje encendido, señal alta resolución A - demasiados impulsos
P0320	800	0320	Sensor posición cigüeñal/régimen motor - circuito defectuoso	P0372	882	0372	Referencia reglaje encendido, señal alta resolución A - pocos impulsos
P0321	801	0321	Sensor posición cigüeñal/régimen motor - rango, funcionamiento	P0373	883	0373	Referencia reglaje encendido, señal alta resolución A - Impulsos intermitentes
P0322	802	0322	Sensor posición cigüeñal/régimen motor - No hay señal	P0374	884	0374	Referencia reglaje encendido, señal alta resolución A - No hay impulsos
P0323	803	0323	Sensor posición cigüeñal/régimen motor - Interrupción intermitente	P0375	885	0375	Referencia reglaje encendido, señal alta resolución B - defectuosa
P0324	804	0324	Error sistema control detonación	P0376	886	0376	Referencia reglaje encendido, señal alta resolución B - demasiados impulsos
P0325	805	0325	Sensor detonación 1 (bloque 1) - circuito defectuoso	P0377	887	0377	Referencia reglaje encendido, señal alta resolución B - pocos impulsos
P0326	806	0326	Sensor detonación 1 (bloque 1) - rango funcionamiento	P0378	888	0378	Referencia reglaje encendido, señal alta resolución B - impulsos intermitentes
P0327	807	0327	Sensor detonación 1 (bloque 1) - señal entrada baja	P0379	889	0379	Referencia reglaje encendido, señal alta resolución B - No hay impulsos
P0328	808	0328	Sensor detonación 1 (bloque 1) - señal entrada alta	P0380	896	0380	Calentadores, circuito A - defectuoso
P0329	809	0329	Sensor detonación 1 (bloque 1) - interrupción intermitente	P0381	897	0381	Testigo calentadores - circuito defectuoso
P0330	816	0330	Sensor detonación 2 (bloque 2) - circuito defectuoso	P0382	898	0382	Calentadores, circuito B - defectuoso
P0331	817	0331	Sensor detonación 2 (bloque 2) - rango, funcionamiento	P0385	901	0385	Sensor posición cigüeñal B - circuito defectuoso
P0332	818	0332	Sensor detonación 2 (bloque 2) - señal entrada baja	P0386	902	0386	Sensor posición cigüeñal B - rango, funcionamiento
P0333	819	0333	Sensor detonación 2 (bloque 2) - señal entrada alta	P0387	903	0387	Sensor posición cigüeñal B - señal entrada baja
P0334	820	0334	Sensor detonación 2 (bloque 2) - interrupción intermitente	P0388	904	0388	Sensor posición cigüeñal B - señal entrada alta
P0335	821	0335	Sensor posición cigüeñal A - circuito defectuoso	P0389	905	0389	Sensor posición cigüeñal B - interrupción intermitente
P0336	822	0336	Sensor posición cigüeñal A - rango, funcionamiento	P0390	912	0390	Sensor posición cigüeñal B (bloque 2) - circuito defectuoso
P0337	823	0337	Sensor posición cigüeñal A - señal entrada baja	P0391	913	0391	Sensor posición cigüeñal B (bloque 2) - rango, funcionamiento
P0338	824	0338	Sensor posición cigüeñal A - señal entrada alta	P0392	914	0392	Sensor posición cigüeñal B (bloque 2) - señal entrada baja
P0339	825	0339	Sensor posición cigüeñal A - interrupción intermitente	P0393	915	0393	Sensor posición cigüeñal B (bloque 2) - señal entrada alta
P0340	832	0340	Sensor posición árbol levas A (bloque 1) - circuito defectuoso	P0394	916	0394	Sensor posición cigüeñal B (bloque 2) - interrupción intermitente
P0341	833	0341	Sensor posición árbol levas A (bloque 1) - rango, funcionamiento	P0400	1024	0400	Recirculación gases escape - flujo defectuoso
P0342	834	0342	Sensor posición árbol levas A (bloque 1) - señal entrada baja	P0401	1025	0401	Recirculación gases escape - flujo insuficiente
P0343	835	0343	Sensor posición árbol levas A (bloque 1) - señal entrada alta	P0402	1026	0402	Recirculación gases escape - flujo excesivo
P0344	836	0344	Sensor posición árbol levas A (bloque 1) - interrupción intermitente	P0403	1027	0403	Recirculación gases escape - circuito defectuoso
P0345	837	0345	Sensor posición árbol levas A (bloque 2) - circuito defectuoso	P0404	1028	0404	Recirculación gases escape - rango, funcionamiento
P0346	838	0346	Sensor posición árbol levas A (bloque 2) - rango, funcionamiento	P0405	1029	0405	Sensor Válvula EGR A - señal baja

P0406	1030	0406	Sensor Válvula EGR A - señal alta	P0457	1111	0457	Sistema emisiones evaporación - fuga detectada
P0407	1031	0407	Sensor Válvula EGR B - señal baja	P0458	1112	0458	Válvula control emisiones evaporación - señal baja
P0408	1032	0408	Sensor Válvula EGR B - señal alta	P0460	1120	0460	Sensor nivel deposito combustible - circuito defectuoso
P0409	1033	0409	Sensor recirculación gases escape A - circuito defectuoso	P0461	1121	0461	Sensor nivel deposito combustible - rango, funcionamiento
P0410	1040	0410	Sistema Inyección aire secundario - defectuoso	P0462	1122	0462	Sensor nivel deposito combustible - señal entrada baja
P0411	1041	0411	Sistema inyección aire secundario - flujo incorrecto	P0463	1123	0463	Sensor nivel deposito combustible - señal entrada alta
P0412	1042	0412	Válvula inyección aire secundario A - circuito defectuoso	P0464	1124	0464	Sensor nivel deposito combustible - interrupción intermitente
P0413	1043	0413	Válvula inyección aire secundario A - circuito abierto	P0465	1125	0465	Sensor flujo purga filtro emisiones evaporación - circuito defectuoso
P0414	1044	0414	Válvula inyección aire secundario A - cortocircuito	P0466	1126	0466	Sensor flujo purga filtro emisiones evaporación - rango, funcionamiento
P0415	1045	0415	Válvula inyección aire secundario B - circuito defectuoso	P0467	1127	0467	Sensor flujo purga filtro emisiones evaporación - señal baja
P0416	1046	0416	Válvula inyección aire secundario B - circuito abierto	P0468	1128	0468	Sensor flujo purga filtro emisiones evaporación - señal alta
P0417	1047	0417	Válvula inyección aire secundario B - cortocircuito	P0469	1129	0469	Sensor flujo purga filtro emisiones evaporación - interrupción intermitente
P0418	1048	0418	Relé inyección aire secundario A - circuito defectuoso	P0470	1136	0470	Sensor presión gases escape - circuito defectuoso
P0419	1049	0419	Relé inyección aire secundario B - circuito defectuoso	P0471	1137	0471	Sensor presión gases escape - rango, funcionamiento
P0420	1056	0420	Sistema catalizador (bloque 1) - eficiencia por debajo umbral	P0472	1138	0472	Sensor presión gases escape - señal baja
P0421	1057	0421	Catalizador delantero (bloque 1) - eficiencia por debajo umbral	P0473	1139	0473	Sensor presión gases escape - señal alta
P0422	1058	0422	Catalizador principal (bloque 1) - eficiencia por debajo umbral	P0474	1140	0474	Sensor presión gases escape - interrupción intermitente
P0423	1059	0423	Catalizador calentado (bloque 1) - eficiencia por debajo umbral	P0475	1141	0475	Válvula reguladora presión gases escape - circuito defectuoso
P0424	1060	0424	Catalizador calentado (bloque 1) - temperatura por debajo umbral	P0476	1142	0476	Válvula reguladora presión gases escape - rango, funcionamiento
P0425	1061	0425	Sensor temperatura catalizador (bloque 1)	P0477	1143	0477	Válvula reguladora presión gases escape - señal baja
P0426	1062	0426	Sensor temperatura catalizador (bloque 1) - rango, funcionamiento	P0478	1144	0478	Válvula reguladora presión gases escape - señal alta
P0427	1063	0427	Sensor temperatura catalizador (bloque 1) - señal baja	P0479	1145	0479	Válvula reguladora presión gases escape - interrupción intermitente
P0428	1064	0428	Sensor temperatura catalizador (bloque 1) - señal alta	P0480	1152	0480	Ventilador refrigerante motor 1 - circuito defectuoso
P0429	1065	0429	Calentador catalizador (bloque 1) - circuito defectuoso	P0481	1153	0481	Ventilador refrigerante motor 2 - circuito defectuoso
P0430	1072	0430	Sistema catalizador (bloque 2) - eficiencia por debajo umbral	P0482	1154	0482	Ventilador refrigerante motor 3 - circuito defectuoso
P0431	1073	0431	Catalizador delantero (bloque 2) - eficiencia por debajo umbral	P0483	1155	0483	Ventilador refrigerante motor, prueba plausibilidad - defectuoso
P0432	1074	0432	Catalizador principal (bloque 2) - eficiencia por debajo umbral	P0484	1156	0484	Ventilador refrigerante motor, sobrecarga corriente en circuito
P0433	1075	0433	Catalizador calentado (bloque 2) - eficiencia por debajo umbral	P0485	1157	0485	Ventilador refrigerante motor, Potencia/Masa - circuito defectuoso
P0434	1076	0434	Catalizador calentado (bloque 2) - temperatura por debajo umbral	P0486	1158	0486	Sensor válvula EGR B - circuito defectuoso
P0435	1077	0435	Sensor temperatura catalizador (bloque 2)	P0487	1159	0487	Recirculación gases escape/posición Mariposa - circuito defectuoso
P0436	1078	0436	Sensor temperatura catalizador (bloque 2) - rango, funcionamiento	P0488	1160	0488	Recirculación gases escape/posición Mariposa - rango, funcionamiento
P0437	1079	0437	Sensor temperatura catalizador (bloque 2) - señal baja	P0489	1161	0489	Recirculación gases escape - señal baja
P0438	1080	0438	Sensor temperatura catalizador (bloque 2) - señal alta	P0490	1168	0490	Recirculación gases escape - señal alta
P0439	1081	0439	Calentador catalizador (bloque 2) - circuito defectuoso	P0491	1169	0491	Sistema inyección aire secundario (bloque 1) - funcionamiento
P0440	1088	0440	Sistema emisiones evaporación - defectuoso	P0492	1170	0492	Sistema inyección aire secundario (bloque 2) - funcionamiento
P0441	1089	0441	Sistema emisiones evaporación - flujo incorrecto	P0493	1171	0493	Sobrevelocidad ventilador refrigerante motor
P0442	1090	0442	Sistema emisiones evaporación - fuga pequeña	P0494	1172	0494	Velocidad ventilador refrigerante motor baja
P0443	1091	0443	Válvula control emisiones evaporación - circuito defectuoso	P0495	1173	0495	Velocidad ventilador refrigerante motor alta
P0444	1092	0444	Válvula control emisiones evaporación - circuito abierto	P0496	1174	0496	Sistema emisiones evaporación - flujo purga alto
P0445	1093	0445	Válvula control emisiones evaporación - cortocircuito	P0497	1175	0497	Sistema emisiones evaporación - flujo purga bajo
P0446	1094	0446	Sistema emisiones evaporación, control ventilación - circuito defectuoso	P0498	1176	0498	Sistema emisiones evaporación, control ventilación - señal baja
P0447	1095	0447	Sistema emisiones evaporación, control ventilación - circuito abierto	P0499	1177	0499	Sistema emisiones evaporación, control ventilación - señal alta
P0448	1096	0448	Sistema emisiones evaporación, control ventilación - cortocircuito	P0500	1280	0500	Sensor velocidad vehículo - circuito defectuoso
P0449	1097	0449	Sistema emisiones evaporación, válvula ventilación - circuito defectuoso	P0501	1281	0501	Sensor velocidad vehículo - rango, funcionamiento
P0450	1104	0450	Sensor presión emisiones evaporación - circuito defectuoso	P0502	1282	0502	Sensor velocidad vehículo - señal entrada baja
P0451	1105	0451	Sensor presión emisiones evaporación - rango, funcionamiento	P0503	1283	0503	Sensor velocidad vehículo - señal alta/intermitente
P0452	1106	0452	Sensor presión emisiones evaporación - señal baja	P0504	1284	0504	Interruptor freno - correlación A/B
P0453	1107	0453	Sensor presión emisiones evaporación - señal alta	P0505	1285	0505	Sistema control ralentí - defectuoso
P0454	1108	0454	Sensor presión emisiones evaporación - interrupción intermitente	P0506	1286	0506	Sistema control ralentí - rpm inferior al previsto
P0455	1109	0455	Sistema emisiones evaporación - fuga grande	P0507	1287	0507	Sistema control ralentí - rpm superior a previsto
P0456	1110	0456	Sistema emisiones evaporación - fuga pequeña	P0508	1288	0508	Control aire ralentí - señal baja

P0509	1289	0509	Control aire ralentí - señal alta	P0561	1377	0561	Tensión del sistema - inestable
P0510	1296	0510	Interruptor mariposa cerrada - circuito defectuoso	P0562	1378	0562	Tensión del sistema - baja
P0511	1297	0511	Control aire ralentí - circuito defectuoso	P0563	1379	0563	Tensión del sistema - alta
P0512	1298	0512	Circuito petición motor arranque - funcionamiento incorrecto	P0564	1380	0564	Control velocidad crucero seña entrada A - circuito defectuoso
P0513	1299	0513	Llave inmovilizadora incorrecta	P0565	1381	0565	Interruptor principal control velocidad, señal ON (encendido) - defectuoso
P0514	1300	0514	Sensor temperatura batería - rango, funcionamiento	P0566	1382	0566	Interruptor principal control velocidad, señal OFF (apagado) - defectuoso
P0515	1301	0515	Sensor temperatura batería - circuito defectuoso	P0567	1383	0567	Interruptor selector control velocidad, RESUME (reanudación) - defectuoso
P0516	1302	0516	Sensor temperatura batería - señal baja	P0568	1384	0568	Interruptor principal control velocidad, señal SET (fijación) - defectuoso
P0517	1303	0517	Sensor temperatura batería - señal alta	P0569	1385	0569	Interruptor selector control velocidad, señal COAST (reducción) - defectuoso
P0518	1304	0518	Control aire ralentí - interrupción intermitente	P0570	1392	0570	Sensor posición pedal acelerador control velocidad - defectuoso
P0519	1305	0519	Control aire ralentí - funcionamiento circuito	P0571	1393	0571	Interruptor de velocidad/de freno A - circuito defectuoso
P0520	1312	0520	Sensor/interruptor presión aceite motor - circuito defectuoso	P0572	1394	0572	Interruptor de velocidad/de freno A - señal baja
P0521	1313	0521	Sensor/interruptor presión aceite motor - rango, funcionamiento	P0573	1395	0573	Interruptor de velocidad/de freno A - señal alta
P0522	1314	0522	Sensor/interruptor presión aceite motor - baja tensión	P0574	1396	0574	Control velocidad crucero - velocidad vehículo alta
P0523	1315	0523	Sensor/interruptor presión aceite motor - alta tensión	P0575	1397	0575	Control velocidad crucero - circuito defectuoso
P0524	1316	0524	Presión aceite motor demasiado baja	P0576	1398	0576	Control velocidad crucero - señal entrada baja
P0525	1317	0525	Control velocidad crucero - rango, funcionamiento	P0577	1399	0577	Control velocidad crucero - señal entrada alta
P0526	1318	0526	Sensor velocidad ventilador refrigerante motor - circuito defectuoso	P0578	1400	0578	Control velocidad crucero, señal entrada A - activación permanente
P0527	1319	0527	Sensor velocidad ventilador refrigerante motor - rango, funcionamiento	P0579	1401	0579	Control velocidad crucero, señal entrada A - rango, funcionamiento
P0528	1320	0528	Sensor velocidad ventilador refrigerante motor - No hay señal	P0580	1408	0580	Control velocidad crucero, señal entrada A - señal baja
P0530	1328	0530	Sensor presión refrigerante Aire acondicionado - circuito defectuoso	P0581	1409	0581	Control velocidad crucero, señal entrada A - señal alta
P0531	1329	0531	Sensor presión refrigerante Aire acondicionado - rango, funcionamiento	P0582	1410	0582	Control velocidad crucero, control vacío - circuito abierto
P0532	1330	0532	Sensor presión refrigerante Aire acondicionado - señal baja	P0583	1411	0583	Control velocidad crucero, control vacío - señal baja
P0533	1331	0533	Sensor presión refrigerante Aire acondicionado - señal alta	P0584	1412	0584	Control velocidad crucero, control vacío - señal alta
P0534	1332	0534	Perdida refrigerante aire acondicionado	P0585	1413	0585	Control velocidad crucero, señal entrada A/B - correlación
P0535	1333	0535	Sensor temperatura evaporador aire acondicionado - circuito defectuoso	P0586	1414	0586	Control velocidad crucero, control ventilación - circuito abierto
P0536	1334	0536	Sensor temperatura evaporador aire acondicionado - rango, funcionamiento	P0587	1415	0587	Control velocidad crucero, control ventilación - señal baja
P0537	1335	0537	Sensor temperatura evaporador aire acondicionado - señal baja	P0588	1416	0588	Control velocidad crucero, control ventilación - señal alta
P0538	1336	0538	Sensor temperatura evaporador aire acondicionado - señal alta	P0589	1417	0589	Control velocidad crucero, señal entrada B - circuito defectuoso
P0539	1337	0539	Sensor temperatura evaporador aire acondicionado - interrupción intermitente	P0590	1424	0590	Control velocidad crucero, señal entrada B - activación permanente
P0540	1344	0540	Calentador aire admisión A - circuito defectuoso	P0591	1425	0591	Control velocidad crucero, señal entrada B - rango, funcionamiento
P0541	1345	0541	Calentador aire admisión A - señal baja	P0592	1426	0592	Control velocidad crucero, señal entrada B - señal baja
P0542	1346	0542	Calentador aire admisión A - señal alta	P0593	1427	0593	Control velocidad crucero, señal entrada B - señal alta
P0543	1347	0543	Calentador aire admisión A - circuito abierto	P0594	1428	0594	Control velocidad crucero, control actuador - circuito abierto
P0544	1348	0544	Sensor temperatura recirculación gases escape (bloque 1) - circuito defectuoso	P0595	1429	0595	Control velocidad crucero, control actuador - señal baja
P0545	1349	0545	Sensor temperatura recirculación gases escape (bloque 1) - señal baja	P0596	1430	0596	Control velocidad crucero, control actuador - señal alta
P0546	1350	0546	Sensor temperatura recirculación gases escape (bloque 1) - señal alta	P0597	1431	0597	Control calentador termostato - circuito abierto
P0547	1351	0547	Sensor temperatura gases escape (bloque 2) - circuito defectuoso	P0598	1432	0598	Control calentador termostato - señal baja
P0548	1352	0548	Sensor temperatura gases escape (bloque 2) - señal baja	P0599	1433	0599	Control calentador termostato - señal alta
P0549	1353	0549	Sensor temperatura gases escape (bloque 2) - señal alta	P0600	1536	0600	Bus de datos CAN - defectuoso
P0550	1360	0550	Sensor/interruptor presión dirección asistida - circuito defectuoso	P0601	1537	0601	Modulo control motor - memoria ROM
P0551	1361	0551	Sensor/interruptor presión dirección asistida - rango, funcionamiento	P0602	1538	0602	Modulo control motor - error programación
P0552	1362	0552	Sensor/interruptor presión dirección asistida - señal baja	P0603	1539	0603	Modulo control motor - error memoria permanente KAM
P0553	1363	0553	Sensor/interruptor presión dirección asistida - señal alta	P0604	1540	0604	Modulo control motor - error memoria RAM
P0554	1364	0554	Sensor/interruptor presión dirección asistida - interrupción intermitente	P0605	1541	0605	Modulo control motor - error memoria ROM
P0555	1365	0555	Sensor presión servofreno - circuito defectuoso	P0606	1542	0606	Modulo de control - fallo del procesador
P0556	1366	0556	Sensor presión servofreno - rango, funcionamiento	P0607	1543	0607	Modulo de control - problema de funcionamiento
P0557	1367	0557	Sensor presión servofreno - señal entrada baja	P0608	1544	0608	Modulo control, señal salida sensor velocidad A - defectuosa
P0558	1368	0558	Sensor presión servofreno - señal entrada alta	P0609	1545	0609	Modulo control, señal salida sensor velocidad B - defectuosa
P0559	1369	0559	Sensor presión servofreno - interrupción intermitente	P0610	1552	0610	Modulo control - error opciones vehículo
P0560	1376	0560	Tensión del sistema - defectuosa	P0611	1553	0611	Modulo control inyector combustible - problema funcionamiento

P0612	1554	0612	Modulo control inyector combustible - circuito Relé	P0663	1635	0663	Válvula control aire colector admisión (bloque 2) - circuito abierto
P0613	1555	0613	Modulo control transmisión - error procesador	P0664	1636	0664	Válvula control aire colector admisión (bloque 2) - señal baja
P0614	1556	0614	Modulo control motor/transmisión - discrepancia	P0665	1637	0665	Válvula control aire colector admisión (bloque 2) - señal alta
P0615	1557	0615	Relé motor arranque - circuito defectuoso	P0666	1638	0666	Sensor temperatura interna modulo motor/transmisión - circuito defectuoso
P0616	1558	0616	Relé motor arranque - señal baja	P0667	1639	0667	Sensor temperatura interna modulo motor/transmisión - rango, funcionamiento
P0617	1559	0617	Relé motor arranque - señal alta	P0668	1640	0668	Sensor temperatura interna modulo motor/transmisión - señal baja
P0618	1560	0618	Modulo control combustible alternativo - error memoria permanente KAM	P0669	1641	0669	Sensor temperatura interna modulo motor/transmisión - señal alta
P0619	1561	0619	Modulo control combustible alternativo - error memoria RAM/ROM	P0670	1648	0670	Modulo control calentadores - circuito defectuoso
P0620	1568	0620	Control Alternador - circuito defectuoso	P0671	1649	0671	Calentadores cilindro 1 - circuito defectuoso
P0621	1569	0621	Testigo alternador - circuito defectuoso	P0672	1650	0672	Calentadores cilindro 2 - circuito defectuoso
P0622	1570	0622	Alternador, control de campo - circuito defectuoso	P0673	1651	0673	Calentadores cilindro 3 - circuito defectuoso
P0623	1571	0623	Testigo control generador - circuito defectuoso	P0674	1652	0674	Calentadores cilindro 4 - circuito defectuoso
P0624	1572	0624	Testigo control tapón llenado - circuito defectuoso	P0675	1653	0675	Calentadores cilindro 5 - circuito defectuoso
P0625	1573	0625	Terminal campo generador - señal baja	P0676	1654	0676	Calentadores cilindro 6 - circuito defectuoso
P0626	1574	0626	Terminal campo generador - señal alta	P0677	1655	0677	Calentadores cilindro 7 - circuito defectuoso
P0627	1575	0627	Control bomba combustible - circuito abierto	P0678	1656	0678	Calentadores cilindro 8 - circuito defectuoso
P0628	1576	0628	Control bomba combustible - señal baja	P0679	1657	0679	Calentadores cilindro 9 - circuito defectuoso
P0629	1577	0629	Control bomba combustible - señal alta	P0680	1664	0680	Calentadores cilindro 10 - circuito defectuoso
P0630	1584	0630	Numero bastidor VIN modulo motor/transmisión - no programado o erróneo	P0681	1665	0681	Calentadores cilindro 11 - circuito defectuoso
P0631	1585	0631	Numero bastidor VIN modulo transmisión - no programado o erróneo	P0682	1666	0682	Calentadores cilindro 12 - circuito defectuoso
P0632	1586	0632	Cuentakilómetros modulo motor/transmisión - no programado	P0683	1667	0683	Comunicación modulo calentadores/motor/transmisión - incorrecto
P0633	1587	0633	Llave inmovilizadora modulo motor/transmisión - no programada	P0684	1668	0684	Comunicación modulo calentadores/motor/transmisión - rango, funcionamiento
P0634	1588	0634	Modulo motor/transmisión - temperatura interna alta	P0685	1669	0685	Relé alimentación modulo motor/transmisión - circuito abierto
P0635	1589	0635	Control dirección asistida - circuito defectuoso	P0686	1670	0686	Relé alimentación modulo motor/transmisión - señal baja
P0636	1590	0636	Control dirección asistida - señal baja	P0687	1671	0687	Relé control motor - cortocircuito a masa
P0637	1591	0637	Control dirección asistida - señal alta	P0688	1672	0688	Relé control motor - cortocircuito a positivo
P0638	1592	0638	Control actuador mariposa (bloque 1) - rango, funcionamiento	P0689	1673	0689	Relé alimentación modulo motor/transmisión - señal baja
P0639	1593	0639	Control actuador mariposa (bloque 2) - rango, funcionamiento	P0690	1680	0690	Relé alimentación modulo motor/transmisión - señal alta
P0640	1600	0640	Control calentador aire admisión - circuito defectuoso	P0691	1681	0691	Ventilador refrigerante motor 1 - cortocircuito a masa
P0641	1601	0641	Tensión referencia sensor A - circuito abierto	P0692	1682	0692	Ventilador refrigerante motor 1 - cortocircuito a positivo
P0642	1602	0642	Control de detonación motor - defectuoso	P0693	1683	0693	Ventilador refrigerante motor 2 - cortocircuito a masa
P0643	1603	0643	Tensión referencia sensor A - señal alta	P0694	1684	0694	Ventilador refrigerante motor 2 - cortocircuito a positivo
P0644	1604	0644	Pantalla del conductor, comunicación serie - circuito defectuoso	P0695	1685	0695	Ventilador refrigerante motor 3 - cortocircuito a masa
P0645	1605	0645	Aire acondicionado	P0696	1686	0696	Ventilador refrigerante motor 3 - cortocircuito a positivo
P0646	1606	0646	Relé embrague compresor aire acondicionado - señal baja	P0697	1687	0697	Tensión referencia sensor C - circuito abierto
P0647	1607	0647	Relé embrague compresor aire acondicionado - señal alta	P0698	1688	0698	Tensión referencia sensor C - señal baja
P0648	1608	0648	Testigo control inmovilizador - circuito defectuoso	P0699	1689	0699	Tensión referencia sensor C - señal alta
P0649	1609	0649	Testigo velocidad crucero - circuito defectuoso	P0700	1792	0700	Sistema control transmisión - defectuoso
P0650	1616	0650	Testigo de averías - circuito defectuoso	P0701	1793	0701	Sistema control transmisión - rango, funcionamiento
P0651	1617	0651	Tensión referencia sensor B - circuito abierto	P0702	1794	0702	Sistema control transmisión - eléctrico
P0652	1618	0652	Tensión referencia sensor B - señal baja	P0703	1795	0703	Convertidor par/interruptor freno B - circuito defectuoso
P0653	1619	0653	Tensión referencia sensor B - señal alta	P0704	1796	0704	Interruptor posición pedal embrague - circuito defectuoso
P0654	1620	0654	Régimen motor (rpm) señal salida - circuito defectuoso	P0705	1797	0705	Sensor/Interruptor marchas cortas/largas P/R/N/D/L - circuito defectuoso
P0655	1621	0655	Señal salida testigo sobrecalentamiento motor - circuito defectuoso	P0706	1798	0706	Sensor/Interruptor marchas cortas/largas - rango, funcionamiento
P0656	1622	0656	Señal salida nivel combustible - circuito defectuoso	P0707	1799	0707	Sensor/Interruptor marchas cortas/largas - señal baja
P0657	1623	0657	Tensión alimentación actuador - circuito abierto	P0708	1800	0708	Sensor/Interruptor marchas cortas/largas - señal alta
P0658	1624	0658	Tensión alimentación actuador - señal baja	P0709	1801	0709	Sensor/Interruptor marchas cortas/largas - interrupción intermitente
P0659	1625	0659	Tensión alimentación actuador - señal alta	P0710	1808	0710	Sensor temperatura aceite transmisión - circuito defectuoso
P0660	1632	0660	Válvula control aire colector admisión (bloque 1) - circuito abierto	P0711	1809	0711	Sensor temperatura aceite transmisión - rango, funcionamiento
P0661	1633	0661	Válvula control aire colector admisión (bloque 1) - señal baja	P0712	1810	0712	Sensor temperatura aceite transmisión - señal baja
P0662	1634	0662	Válvula control aire colector admisión (bloque 1) - señal alta	P0713	1811	0713	Sensor temperatura aceite transmisión - señal alta

P0714	1812	0714	Sensor temperatura aceite transmisión - interrupción intermitente	P0766	1894	0766	Electroválvula cambio D - funcionamiento, desactivado
P0715	1813	0715	Sensor velocidad giro árbol turbina - circuito defectuoso	P0767	1895	0767	Electroválvula cambio D - activado permanente
P0716	1814	0716	Sensor velocidad giro árbol turbina - rango, funcionamiento	P0768	1896	0768	Electroválvula cambio D - circuito eléctrico
P0717	1815	0717	Sensor velocidad giro árbol turbina - no hay señal	P0769	1897	0769	Electroválvula cambio D - interrupción intermitente
P0718	1816	0718	Sensor velocidad giro árbol turbina - interrupción intermitente	P0770	1904	0770	Electroválvula cambio E - circuito defectuoso
P0719	1817	0719	Convertidor par/interruptor freno B - señal baja	P0771	1905	0771	Electroválvula cambio E - funcionamiento, desactivado
P0720	1824	0720	Sensor velocidad vehículo - circuito defectuoso	P0772	1906	0772	Electroválvula cambio E - activado permanente
P0721	1825	0721	Sensor velocidad vehículo - rango, funcionamiento	P0773	1907	0773	Electroválvula cambio E - circuito eléctrico
P0722	1826	0722	Sensor velocidad vehículo - no hay señal	P0774	1908	0774	Electroválvula cambio E - interrupción intermitente
P0723	1827	0723	Sensor velocidad vehículo - interrupción intermitente	P0775	1909	0775	Solenoides control presión B - circuito defectuoso
P0724	1828	0724	Convertidor par/interruptor freno B - señal alta	P0776	1910	0776	Solenoides control presión B - funcionamiento, desactivado
P0725	1829	0725	Señal entrada régimen motor - circuito defectuoso	P0777	1911	0777	Solenoides control presión B - activado permanente
P0726	1830	0726	Señal entrada régimen motor - rango, funcionamiento	P0778	1912	0778	Solenoides control presión B - avería eléctrica
P0727	1831	0727	Señal entrada régimen motor - no hay señal	P0779	1913	0779	Solenoides control presión B - interrupción intermitente
P0728	1832	0728	Señal entrada régimen motor - interrupción intermitente	P0780	1920	0780	Selección de marchas - cambio defectuoso
P0730	1840	0730	Relación de marchas incorrecta	P0781	1921	0781	Selección de marchas 1-2 - cambio defectuoso
P0731	1841	0731	Marcha 1 - relación incorrecta	P0782	1922	0782	Selección de marchas 2-3 - cambio defectuoso
P0732	1842	0732	Marcha 2 - relación incorrecta	P0783	1923	0783	Selección de marchas 3-4 - cambio defectuoso
P0733	1843	0733	Marcha 3 - relación incorrecta	P0784	1924	0784	Selección de marchas 4-5 - cambio defectuoso
P0734	1844	0734	Marcha 4 - relación incorrecta	P0785	1925	0785	Electroválvula cambio/reglaje - circuito defectuoso
P0735	1845	0735	Marcha 5 - relación incorrecta	P0786	1926	0786	Electroválvula cambio/reglaje - rango, funcionamiento
P0736	1846	0736	Marcha atrás - relación incorrecta	P0787	1927	0787	Electroválvula cambio/reglaje - señal baja
P0737	1847	0737	Régimen motor modulo control transmisión - circuito salida	P0788	1928	0788	Electroválvula cambio/reglaje - señal alta
P0738	1848	0738	Régimen motor modulo control transmisión - señal salida baja	P0789	1929	0789	Electroválvula cambio/reglaje - señal intermitente
P0739	1849	0739	Régimen motor modulo control transmisión - señal salida alta	P0790	1936	0790	Interruptor selección modo cambio - circuito defectuoso
P0740	1856	0740	Válvula embrague convertidor par - circuito defectuoso	P0791	1937	0791	Sensor velocidad giro árbol intermedio - circuito defectuoso
P0741	1857	0741	Válvula embrague convertidor par - funcionamiento, desactivado	P0792	1938	0792	Sensor velocidad giro árbol intermedio - rango, funcionamiento
P0742	1858	0742	Válvula embrague convertidor par - activado permanente	P0793	1939	0793	Sensor velocidad giro árbol intermedio - No hay señal
P0743	1859	0743	Válvula embrague convertidor par - circuito eléctrico	P0794	1940	0794	Sensor velocidad giro árbol intermedio - avería intermitente
P0744	1860	0744	Válvula embrague convertidor par - interrupción intermitente	P0795	1941	0795	Solenoides presión aceite transmisión C - circuito defectuoso
P0745	1861	0745	Solenoides presión aceite transmisión - circuito defectuoso	P0796	1942	0796	Solenoides presión aceite transmisión C - funcionamiento, desactivado
P0746	1862	0746	Solenoides presión aceite transmisión - funcionamiento, desactivado	P0797	1943	0797	Solenoides presión aceite transmisión C - activado permanente
P0747	1863	0747	Solenoides presión aceite transmisión - activado permanente	P0798	1944	0798	Solenoides presión aceite transmisión C - avería eléctrica
P0748	1864	0748	Solenoides presión aceite transmisión - circuito eléctrico	P0799	1945	0799	Solenoides presión aceite transmisión C - avería intermitente
P0749	1865	0749	Solenoides presión aceite transmisión - interrupción intermitente	P0800	2048	0800	Control caja transferencia, petición testigo averías - funcionamiento incorrecto
P0750	1872	0750	Electroválvula cambio A - circuito defectuoso	P0801	2049	0801	Circuito inhibidor marcha atrás - circuito defectuoso
P0751	1873	0751	Electroválvula cambio A - funcionamiento, desactivado	P0802	2050	0802	Sistema control transmisión, petición testigo averías - circuito abierto
P0752	1874	0752	Electroválvula cambio A - activado permanente	P0803	2051	0803	Electroválvula cambio a mayor 1-4 (omisión de marcha) - circuito defectuoso
P0753	1875	0753	Electroválvula cambio A - circuito eléctrico	P0804	2052	0804	Testigo cambio a mayor 1-4 (omisión de marcha) - circuito defectuoso
P0754	1876	0754	Electroválvula cambio A - interrupción intermitente	P0805	2053	0805	Sensor posición embrague - circuito defectuoso
P0755	1877	0755	Electroválvula cambio B - circuito defectuoso	P0806	2054	0806	Sensor posición embrague - rango, funcionamiento
P0756	1878	0756	Electroválvula cambio B - funcionamiento, desactivado	P0807	2055	0807	Sensor posición embrague - señal entrada baja
P0757	1879	0757	Electroválvula cambio B - activado permanente	P0808	2056	0808	Sensor posición embrague - señal entrada alta
P0758	1880	0758	Electroválvula cambio B - circuito eléctrico	P0809	2057	0809	Sensor posición embrague - avería intermitente
P0759	1881	0759	Electroválvula cambio B - interrupción intermitente	P0810	2064	0810	Error control posición embrague
P0760	1888	0760	Electroválvula cambio C - circuito defectuoso	P0811	2065	0811	Deslizamiento excesivo embrague
P0761	1889	0761	Electroválvula cambio C - funcionamiento, desactivado	P0812	2066	0812	Marcha atrás - circuito entrada defectuoso
P0762	1890	0762	Electroválvula cambio C - activado permanente	P0813	2067	0813	Marcha atrás - circuito salida defectuoso
P0763	1891	0763	Electroválvula cambio C - circuito eléctrico	P0814	2068	0814	Display marchas cortas/largas - circuito defectuoso
P0764	1892	0764	Electroválvula cambio C - interrupción intermitente	P0815	2069	0815	Interruptor de cambio a mayor - circuito defectuoso
P0765	1893	0765	Electroválvula cambio D - circuito defectuoso	P0816	2070	0816	Interruptor de cambio a menor - circuito defectuoso

P0817	2071	0817	Inhabilitación motor arranque - circuito defectuoso	P0867	2151	0867	Sensor presión aceite transmisión
P0818	2072	0818	Interruptor desconexión transmisión - circuito defectuoso	P0868	2152	0868	Sensor presión aceite transmisión - señal baja
P0819	2073	0819	Interruptor cambio marchas cortas/largas	P0869	2153	0869	Sensor presión aceite transmisión - señal alta
P0820	2080	0820	Sensor posición X-Y palanca cambios - circuito defectuoso	P0870	2160	0870	Sensor/Interruptor presión aceite transmisión C - circuito defectuoso
P0821	2081	0821	Sensor posición X palanca cambios - circuito defectuoso	P0871	2161	0871	Sensor/Interruptor presión aceite transmisión C - rango, funcionamiento
P0822	2082	0822	Sensor posición Y palanca cambios - circuito defectuoso	P0872	2162	0872	Sensor/Interruptor presión aceite transmisión C - señal baja
P0823	2083	0823	Sensor posición X palanca cambios - interrupción intermitente	P0873	2163	0873	Sensor/Interruptor presión aceite transmisión C - señal alta
P0824	2084	0824	Sensor posición Y palanca cambios - interrupción intermitente	P0874	2164	0874	Sensor/Interruptor presión aceite transmisión C - interrupción intermitente
P0825	2085	0825	Interruptor dirección palanca cambios - circuito defectuoso	P0875	2165	0875	Sensor/Interruptor presión aceite transmisión D - circuito defectuoso
P0826	2086	0826	Interruptor cambio a mayor/menor - circuito defectuoso	P0876	2166	0876	Sensor/Interruptor presión aceite transmisión D - rango, funcionamiento
P0827	2087	0827	Interruptor cambio a mayor/menor - señal baja	P0877	2167	0877	Sensor/Interruptor presión aceite transmisión D - señal baja
P0828	2088	0828	Interruptor cambio a mayor/menor - señal alta	P0878	2168	0878	Sensor/Interruptor presión aceite transmisión D - señal alta
P0829	2089	0829	Cambia a mayor 5-6	P0879	2169	0879	Sensor/Interruptor presión aceite transmisión D - interrupción intermitente
P0830	2096	0830	Interruptor posición pedal embrague A - circuito defectuoso	P0880	2176	0880	Modulo control transmisión, señal entrada alimentación - circuito defectuoso
P0831	2097	0831	Interruptor posición pedal embrague A - señal entrada baja	P0881	2177	0881	Modulo control transmisión, señal entrada alimentación - rango, funcionamiento
P0832	2098	0832	Interruptor posición pedal embrague A - señal entrada alta	P0882	2178	0882	Modulo control transmisión, señal entrada alimentación - señal baja
P0833	2099	0833	Interruptor posición pedal embrague B - circuito defectuoso	P0883	2179	0883	Modulo control transmisión, señal entrada alimentación - señal alta
P0834	2100	0834	Interruptor posición pedal embrague B - señal entrada baja	P0884	2180	0884	Modulo control transmisión, señal entrada alimentación - interrupción
P0835	2101	0835	Interruptor posición pedal embrague B - señal entrada alta				intermitente
P0836	2102	0836	Interruptor tracción total - circuito defectuoso	P0885	2181	0885	Relé alimentación modulo control transmisión - circuito abierto
P0837	2103	0837	Interruptor tracción total - rango, funcionamiento	P0886	2182	0886	Relé alimentación modulo control transmisión - señal baja
P0838	2104	0838	Interruptor tracción total - señal entrada baja	P0887	2183	0887	Relé alimentación modulo control transmisión - señal alta
P0839	2105	0839	Interruptor tracción total - señal entrada alta	P0888	2184	0888	Relé alimentación modulo control transmisión, supervisión - circuito defectuoso
P0840	2112	0840	Sensor/Interruptor presión aceite transmisión A - circuito defectuoso	P0889	2185	0889	Relé alimentación modulo control transmisión, supervisión - rango,
P0841	2113	0841	Sensor/Interruptor presión aceite transmisión A - rango, funcionamiento				funcionamiento
P0842	2114	0842	Sensor/Interruptor presión aceite transmisión A - señal entrada baja	P0890	2192	0890	Relé alimentación modulo control transmisión, supervisión - señal baja
P0843	2115	0843	Sensor/Interruptor presión aceite transmisión A - señal entrada alta	P0891	2193	0891	Relé alimentación modulo control transmisión, supervisión - señal alta
P0844	2116	0844	Sensor/Interruptor presión aceite transmisión A - interrupción intermitente	P0892	2194	0892	Relé alimentación modulo control transmisión, supervisión - interrupción
P0845	2117	0845	Sensor/Interruptor presión aceite transmisión B - circuito defectuoso				intermitente
P0846	2118	0846	Sensor/Interruptor presión aceite transmisión B - rango, funcionamiento	P0893	2195	0893	Varias marchas engranadas
P0847	2119	0847	Sensor/Interruptor presión aceite transmisión B - señal entrada baja	P0894	2196	0894	Deslizamiento componente transmisión
P0848	2120	0848	Sensor/Interruptor presión aceite transmisión B - señal entrada alta	P0895	2197	0895	Tiempo de cambio escaso
P0849	2121	0849	Sensor/Interruptor presión aceite transmisión B - interrupción intermitente	P0896	2198	0896	Tiempo de cambio excesivo
P0850	2128	0850	Interruptor posición estacionamiento/punto muerto - circuito defectuoso	P0897	2199	0897	Aceite transmisión deteriorado
P0851	2129	0851	Interruptor posición estacionamiento/punto muerto - señal entrada baja	P0898	2200	0898	Transmisión, petición testigo averías - señal baja
P0852	2130	0852	Interruptor posición estacionamiento/punto muerto - señal entrada alta	P0899	2201	0899	Transmisión, petición testigo averías - señal alta
P0853	2131	0853	Interruptor conducción automática transmisión - circuito defectuoso	P0900	2304	0900	Actuador embrague - circuito abierto
P0854	2132	0854	Interruptor conducción automática transmisión - señal entrada baja	P0901	2305	0901	Actuador embrague - rango, funcionamiento
P0855	2133	0855	Interruptor conducción automática transmisión - señal entrada alta	P0902	2306	0902	Actuador embrague - señal baja
P0856	2134	0856	Control tracción - circuito defectuoso	P0903	2307	0903	Actuador embrague - señal alta
P0857	2135	0857	Control tracción - rango, funcionamiento	P0904	2308	0904	Posición neutral caja cambios - circuito defectuoso
P0858	2136	0858	Control tracción - señal entrada baja	P0905	2309	0905	Posición neutral caja cambios - rango, funcionamiento
P0859	2137	0859	Control tracción - señal entrada alta	P0906	2310	0906	Posición neutral caja cambios - señal baja
P0860	2144	0860	Comunicación modulo cambio marchas - circuito defectuoso				
P0861	2145	0861	Comunicación modulo cambio marchas - señal entrada baja	P0907	2311	0907	Posición neutral caja cambios - <b>señal alta</b>
P0862	2146	0862	Comunicación modulo cambio marchas - señal entrada alta	P0908	2312	0908	Posición neutral caja cambios - interrupción intermitente
P0863	2147	0863	Comunicación modulo transmisión - circuito defectuoso	P0909	2313	0909	Error regulación posición neutral caja cambios
P0864	2148	0864	Comunicación modulo transmisión - rango, funcionamiento	P0910	2320	0910	Actuador selección posición neutral caja cambios - circuito defectuoso
P0865	2149	0865	Comunicación modulo transmisión - señal entrada baja	P0911	2321	0911	Actuador selección posición neutral caja cambios - rango, funcionamiento
P0866	2150	0866	Comunicación modulo transmisión - señal entrada <b>alta</b>	P0912	2322	0912	Actuador selección posición neutral caja cambios - señal baja
				P0913	2323	0913	Actuador selección posición neutral caja cambios - señal alta

P0914	2324	0914	Circuito posición cambio marchas - circuito defectuoso	P0965	2405	0965	Solenoid control presión B - rango, funcionamiento
P0915	2325	0915	Circuito posición cambio marchas - rango, funcionamiento	P0966	2406	0966	Solenoid control presión B - señal baja
P0916	2326	0916	Circuito posición cambio marchas - señal baja	P0967	2407	0967	Solenoid control presión B - señal alta
P0917	2327	0917	Circuito posición cambio marchas - señal alta	P0968	2408	0968	Solenoid control presión C - circuito defectuoso
P0918	2328	0918	Circuito posición cambio marchas - interrupción intermitente	P0969	2409	0969	Solenoid control presión C - rango, funcionamiento
P0919	2329	0919	Control posición cambio marchas - error	P0970	2416	0970	Solenoid control presión C - señal baja
P0920	2336	0920	Actuador avance cambio marchas - circuito defectuoso	P0971	2417	0971	Solenoid control presión C - señal alta
P0921	2337	0921	Actuador avance cambio marchas - rango, funcionamiento	P0972	2418	0972	Electroválvula de cambio A - rango, funcionamiento
P0922	2338	0922	Actuador avance cambio marchas - señal baja	P0973	2419	0973	Electroválvula de cambio A - señal baja
P0923	2339	0923	Actuador avance cambio marchas - señal alta	P0974	2420	0974	Electroválvula de cambio A - señal alta
P0924	2340	0924	Actuador retroceso cambio marchas - circuito defectuoso	P0975	2421	0975	Electroválvula de cambio B - rango, funcionamiento
P0925	2341	0925	Actuador retroceso cambio marchas - rango, funcionamiento	P0976	2422	0976	Electroválvula de cambio B - señal baja
P0926	2342	0926	Actuador retroceso cambio marchas - señal baja	P0977	2423	0977	Electroválvula de cambio B - señal alta
P0927	2343	0927	Actuador retroceso cambio marchas - señal alta	P0978	2424	0978	Electroválvula de cambio C - rango, funcionamiento
P0928	2344	0928	Electroválvula bloqueo cambio marchas - circuito defectuoso	P0979	2425	0979	Electroválvula de cambio C - señal baja
P0929	2345	0929	Electroválvula bloqueo cambio marchas - rango, funcionamiento	P0980	2432	0980	Electroválvula de cambio C - señal alta
P0930	2352	0930	Electroválvula bloqueo cambio marchas - señal baja	P0981	2433	0981	Electroválvula de cambio D - rango, funcionamiento
P0931	2353	0931	Electroválvula bloqueo cambio marchas - señal alta	P0982	2434	0982	Electroválvula de cambio D - señal baja
P0932	2354	0932	Sensor presión hidráulica - circuito defectuoso	P0983	2435	0983	Electroválvula de cambio D - señal alta
P0933	2355	0933	Sensor presión hidráulica - rango, funcionamiento	P0984	2436	0984	Electroválvula de cambio E - rango, funcionamiento
P0934	2356	0934	Sensor presión hidráulica - señal entrada baja	P0985	2437	0985	Electroválvula de cambio E - señal baja
P0935	2357	0935	Sensor presión hidráulica - señal entrada alta	P0986	2438	0986	Electroválvula de cambio E - señal alta
P0936	2358	0936	Sensor presión hidráulica - interrupción intermitente	P0987	2439	0987	Sensor/Interruptor presión aceite transmisión E - circuito defectuoso
P0937	2359	0937	Sensor temperatura aceite hidráulico - circuito defectuoso	P0988	2440	0988	Sensor/Interruptor presión aceite transmisión E - rango, funcionamiento
P0938	2360	0938	Sensor temperatura aceite hidráulico - rango, funcionamiento	P0989	2441	0989	Sensor/Interruptor presión aceite transmisión E - señal baja
P0939	2361	0939	Sensor temperatura aceite hidráulico - señal entrada baja	P0990	2448	0990	Sensor/Interruptor presión aceite transmisión E - señal alta
P0940	2368	0940	Sensor temperatura aceite hidráulico - señal entrada alta	P0991	2449	0991	Sensor/Interruptor presión aceite transmisión E - interrupción intermitente
P0941	2369	0941	Sensor temperatura aceite hidráulico - interrupción intermitente	P0992	2450	0992	Sensor/Interruptor presión aceite transmisión F - circuito defectuoso
P0942	2370	0942	Unidad presión hidráulica	P0993	2451	0993	Sensor/Interruptor presión aceite transmisión F - rango, funcionamiento
P0943	2371	0943	Unidad presión hidráulica - recorrido corto	P0994	2452	0994	Sensor/Interruptor presión aceite transmisión F - señal baja
P0944	2372	0944	Unidad presión hidráulica - pérdida presión	P0995	2453	0995	Sensor/Interruptor presión aceite transmisión F - señal alta
P0945	2373	0945	Relé bomba hidráulica - circuito abierto	P0996	2454	0996	Sensor/Interruptor presión aceite transmisión F - interrupción intermitente
P0946	2374	0946	Relé bomba hidráulica - rango, funcionamiento	P0997	2455	0997	Electroválvula cambio F - rango, funcionamiento
P0947	2375	0947	Relé bomba hidráulica - señal baja	P0998	2456	0998	Electroválvula cambio F - señal baja
P0948	2376	0948	Relé bomba hidráulica - señal alta	P0999	2457	0999	Electroválvula cambio F - señal alta
P0949	2377	0949	Cambio manual automatizado (ASM) - valores adaptativos no registrados	POA00	2560	0A00	Motor Electronics Coolant Temperature Sensor Circuit
P0950	2384	0950	Cambio manual automatizado (ASM) - circuito defectuoso	POA01	2561	0A01	Motor Electronics Coolant Temperature Sensor Circuit Range/Performance
P0951	2385	0951	Cambio manual automatizado (ASM) - rango, funcionamiento	POA02	2562	0A02	Motor Electronics Coolant Temperature Sensor Circuit Low
P0952	2386	0952	Cambio manual automatizado (ASM) - señal baja	POA03	2563	0A03	Motor Electronics Coolant Temperature Sensor Circuit High
P0953	2387	0953	Cambio manual automatizado (ASM) - señal alta	POA04	2564	0A04	Motor Electronics Coolant Temperature Sensor Circuit Intermittent
P0954	2388	0954	Cambio manual automatizado (ASM) - interrupción intermitente	POA05	2565	0A05	Motor Electronics Coolant Pump Control Circuit/Open
P0955	2389	0955	Circuito modo cambio manual automatizado (ASM) - circuito defectuoso	POA06	2566	0A06	Motor Electronics Coolant Pump Control Circuit Low
P0956	2390	0956	Circuito modo cambio manual automatizado (ASM) - rango, funcionamiento	POA07	2567	0A07	Motor Electronics Coolant Pump Control Circuit High
P0957	2391	0957	Circuito modo cambio manual automatizado (ASM) - señal baja	POA08	2568	0A08	DC/DC Converter Status Circuit
P0958	2392	0958	Circuito modo cambio manual automatizado (ASM) - señal alta	POA09	2569	0A09	DC/DC Converter Status Circuit Low Input
P0959	2393	0959	Circuito modo cambio manual automatizado (ASM) - interrupción intermitente	POA10	2576	0A10	DC/DC Converter Status Circuit High Input
P0960	2400	0960	Solenoid control presión A - circuito defectuoso	POA11	2577	0A11	DC/DC Converter Enable Circuit/Open
P0961	2401	0961	Solenoid control presión A - rango, funcionamiento	POA12	2578	0A12	DC/DC Converter Enable Circuit Low
P0962	2402	0962	Solenoid control presión A - señal baja	POA13	2579	0A13	DC/DC Converter Enable Circuit High
P0963	2403	0963	Solenoid control presión A - señal alta	POA14	2580	0A14	Engine Mount Control Circuit/Open
P0964	2404	0964	Solenoid control presión B - circuito defectuoso	POA15	2581	0A15	Engine Mount Control Circuit Low

POA16	2582	0A16	Engine Mount Control Circuit High	P1135	4405	1135	Sensor posición pedal A - circuito defectuoso
POA17	2583	0A17	Motor Torque Sensor Circuit	P1136	4406	1136	Ventilador motor - circuito defectuoso
POA18	2584	0A18	Motor Torque Sensor Circuit Range/Performance	P1137	4407	1137	Sonda lambda 1 bloque 2 - mezcla pobre
POA19	2585	0A19	Motor Torque Sensor Circuit Low	P1138	4408	1138	Sonda lambda 1 bloque 2 - mezcla rica
POA20	2592	0A20	Motor Torque Sensor Circuit High	P1139	4409	1139	Indicador agua en combustible - circuito defectuoso
POA21	2593	0A21	Motor Torque Sensor Circuit Intermittent	P1140	4416	1140	Agua en el combustible
POA22	2594	0A22	Generator Torque Sensor Circuit	P1141	4417	1141	Indicador restricción combustible - circuito defectuoso
POA23	2595	0A23	Generator Torque Sensor Circuit Range/Performance	P1142	4418	1142	Restricción combustible
POA24	2596	0A24	Generator Torque Sensor Circuit Low	P1143	4419	1143	Válvula control aire asistido - rango, funcionamiento
POA25	2597	0A25	Generator Torque Sensor Circuit High	P1144	4420	1144	Válvula control aire asistido - circuito defectuoso
POA26	2598	0A26	Generator Torque Sensor Circuit Intermittent	P1145	4421	1145	Error de par calculado
POA27	2599	0A27	Battery Power Off Circuit	P1150	4432	1150	Sonda lambda - regulación inyección al limite
POA28	2600	0A28	Battery Power Off Circuit Low	P1151	4433	1151	Sonda lambda - mezcla pobre
POA29	2601	0A29	Battery Power Off Circuit High	P1152	4434	1152	Sonda lambda - mezcla rica
P1000	4096	1000	Prueba preparacion sistema no completada	P1153	4435	1153	Control combustible (Bloque 2) - mezcla pobre
P1001	4097	1001	Diagnosis del sistema incompleta	P1154	4436	1154	Control combustible (bloque 2) - mezcla rica
P1100	4352	1100	Sensor flujo masa aire - interrupción intermitente	P1155	4437	1155	Controlador alternativo combustible
P1101	4353	1101	Sensor flujo masa aire - fuera limites	P1156	4438	1156	Interruptor selección combustible - circuito defectuoso
P1102	4354	1102	Sensor MAF menor que previsto	P1157	4439	1157	Sonda lambda 2 bloque 2 - mezcla pobre
P1103	4355	1103	Sensor MAF mayor que previsto	P1158	4440	1158	Sonda lambda 2 bloque 2 - mezcla rica
P1104	4356	1104	Sensor MAF - circuito defectuoso	P1159	4441	1159	Motor paso a paso combustible - circuito defectuoso
P1105	4357	1105	Sensor presión barométrica - circuito defectuoso	P1167	4455	1167	Fallo diagnosis, Mariposa no soltada
P1106	4358	1106	Alternador/Sensor MAP señal tensión baja	P1168	4456	1168	Sensor combustible rail - valor muy bajo
P1107	4359	1107	Alternador/Sensor MAP señal tensión baja	P1169	4457	1169	Sensor combustible rail - valor muy alto
P1108	4360	1108	Testigo Batería, alternador - circuito defectuoso	P1170	4464	1170	Solenoid desconexión motor - fallo
P1109	4361	1109	Temperatura aire admisión - avería intermitente	P1171	4465	1171	Sensor rotor - fallo
P1110	4368	1110	Temperatura aire admisión - circuito abierto	P1172	4466	1172	Control rotor - fallo
P1111	4369	1111	Temperatura aire admisión - interrupción intermitente/alta	P1173	4467	1173	Calibración rotor - fallo
P1112	4370	1112	Temperatura aire admisión - interrupción intermitente/baja	P1174	4468	1174	Sensor árbol levas - fallo
P1113	4371	1113	Temperatura aire admisión - circuito abierto	P1175	4469	1175	Control árbol levas - fallo
P1114	4372	1114	Temperatura motor intermitente/Aire admisión señal entrada baja	P1176	4470	1176	Calibración árbol levas - fallo
P1115	4373	1115	Temperatura motor intermitente/Aire admisión señal entrada alta	P1177	4471	1177	Fallo sincronización
P1116	4374	1116	Temperatura motor fuera de rango	P1178	4472	1178	Circuito abierto
P1117	4375	1117	Sensor temperatura refrigerante motor - interrupción intermitente	P1180	4480	1180	Sensor temperatura combustible -señal baja
P1118	4376	1118	Sensor Temperatura absoluta escape - señal entrada baja	P1181	4481	1181	Sensor temperatura combustible -señal alta
P1119	4377	1119	Sensor Temperatura absoluta escape - señal entrada alta	P1182	4482	1182	Solenoid desconexión combustible - circuito defectuoso
P1120	4384	1120	Sensor posición mariposa - fuera de rango	P1183	4483	1183	Temperatura aceite motor - circuito defectuoso
P1121	4385	1121	Sensor posición mariposa - intermitente, señal alta	P1184	4484	1184	Temperatura aceite motor - fuera de rango
P1122	4386	1122	Sensor posición mariposa - intermitente, señal baja	P1185	4485	1185	Sensor temperatura bomba combustible - alto
P1123	4387	1123	Sensor posición mariposa - valor elevado	P1186	4486	1186	Sensor temperatura bomba combustible - bajo
P1124	4388	1124	Sensor posición mariposa - fuera limites	P1187	4487	1187	Selección variante
P1125	4389	1125	Sensor posición mariposa - interrupción intermitente	P1188	4488	1188	Fallo calibración memoria
P1126	4390	1126	Sensor posición mariposa - circuito defectuoso	P1189	4489	1189	Velocidad Bomba - fallo señal
P1127	4391	1127	Temperatura escape - fuera de rango	P1190	4496	1190	Resistencia Calibración fuera de rango
P1128	4392	1128	Sondas lambda 1 - transpuestos	P1191	4497	1191	Tensión línea llave
P1129	4393	1129	Sondas lambda 2 - transpuestos	P1192	4498	1192	Tensión externa
P1130	4400	1130	Sonda lambda - regulación inyección limite	P1193	4499	1193	Controlador sobre corriente EGR
P1131	4401	1131	Sonda lambda - mezcla pobre	P1194	4500	1194	UCE conversor A/D
P1132	4402	1132	Sonda lambda - mezcla rica	P1195	4501	1195	Bomba combustible - fallo inicializar
P1133	4403	1133	Sonda lambda 1 - Insuficiente	P1196	4502	1196	Tensión apagado llave - valor alto
P1134	4404	1134	Sonda lambda 1 - tiempo reacción	P1197	4503	1197	Tensión apagado llave - valor bajo



P1198	4504	1198	Control rotor combustible - bajo combustible	P1251	4689	1251	Solenoide mezcla aire - circuito defectuoso
P1199	4505	1199	Nivel combustible - señal entrada baja	P1252	4690	1252	Correlación pedal PDS1 y LPDS alta
P1200	4608	1200	Inyector - rango, funcionamiento	P1253	4691	1253	Correlación pedal PDS1 y LPDS baja
P1201	4609	1201	Inyector Cilindro 1 - circuito abierto, cortocircuito	P1254	4692	1254	Correlación pedal PDS2 y LPDS alta
P1202	4610	1202	Inyector Cilindro 2 - circuito abierto, cortocircuito	P1255	4693	1255	Correlación pedal PDS2 y LPDS baja
P1203	4611	1203	Inyector Cilindro 3 - circuito abierto, cortocircuito	P1256	4694	1256	Correlación pedal PDS1 y HPDS
P1204	4612	1204	Inyector Cilindro 4 - circuito abierto, cortocircuito	P1257	4695	1257	Correlación pedal PDS2 y HPDS
P1205	4613	1205	Inyector Cilindro 5 - circuito abierto, cortocircuito	P1258	4696	1258	Correlación pedal PDS1 y PDS2
P1206	4614	1206	Inyector Cilindro 6 - circuito abierto, cortocircuito	P1259	4697	1259	Error señal inmovilizador a modulo motor
P1209	4617	1209	Presión control inyector - fallo sistema	P1260	4704	1260	Robo detectado - vehículo inmovilizado
P1210	4624	1210	Presión control inyector - valor superior esperado	P1261	4705	1261	Cilindro 1 alto a bajo - corto
P1211	4625	1211	Presión control inyector - alta/baja	P1262	4706	1262	Cilindro 2 alto a bajo - corto
P1212	4626	1212	Presión control inyector - sin señal	P1263	4707	1263	Cilindro 3 alto a bajo - corto
P1213	4627	1213	Inyector arranque - circuito defectuoso	P1264	4708	1264	Cilindro 4 alto a bajo - corto
P1214	4628	1214	Sensor posición pedal B - interrupción intermitente	P1265	4709	1265	Cilindro 5 alto a bajo - corto
P1215	4629	1215	Sensor posición pedal C - señal entrada baja	P1266	4710	1266	Cilindro 6 alto a bajo - corto
P1216	4630	1216	Sensor posición pedal C - señal entrada alta	P1267	4711	1267	Cilindro 7 alto a bajo - corto
P1217	4631	1217	Sensor posición pedal C - interrupción intermitente	P1268	4712	1268	Cilindro 8 alto a bajo - corto
P1218	4632	1218	Control Inyección - alto	P1269	4713	1269	Código inmovilizador no programado
P1219	4633	1219	Control Inyección - bajo	P1270	4720	1270	Régimen motor/velocidad vehículo máximos alcanzados
P1220	4640	1220	Control Mariposa - circuito defectuoso	P1271	4721	1271	Cilindro 1 alto a bajo - abierto
P1221	4641	1221	Control Tracción - circuito defectuoso	P1272	4722	1272	Cilindro 2 alto a bajo - abierto
P1222	4642	1222	Control Tracción salida - circuito defectuoso	P1273	4723	1273	Cilindro 3 alto a bajo - abierto
P1223	4643	1223	Parada de emergencia redundante	P1274	4724	1274	Cilindro 4 alto a bajo - abierto
P1224	4644	1224	Sensor posición Mariposa B - valor fuera de rango	P1275	4725	1275	Cilindro 5 alto a bajo - abierto
P1225	4645	1225	Sensor elevación aguja inyector	P1276	4726	1276	Cilindro 6 alto a bajo - abierto
P1226	4646	1226	Sensor posición regulador cantidad combustible - circuito defectuoso	P1277	4727	1277	Cilindro 7 alto a bajo - abierto
P1227	4647	1227	Solenoide reglaje inyección - valor Sobrepresión	P1278	4728	1278	Cilindro 8 alto a bajo - abierto
P1228	4648	1228	Solenoide reglaje inyección - valor bajo presión	P1280	4736	1280	Presión control inyección - demasiado bajo
P1229	4649	1229	Controlador bomba intercooler - fallo	P1281	4737	1281	Presión control inyección - demasiado alto
P1230	4656	1230	Bomba combustible velocidad baja - circuito defectuoso	P1282	4738	1282	Presión control inyección - excesiva
P1231	4657	1231	Bomba combustible secundaria, alta velocidad - señal baja	P1283	4739	1283	Regulador presión inyector - circuito defectuoso
P1232	4658	1232	Velocidad bomba combustible principal - circuito defectuoso	P1284	4740	1284	Fallo en presión control inyector
P1233	4659	1233	Modulo Controlador Bomba combustible desconexión línea	P1285	4741	1285	Sensor temperatura culata - sobrecalentamiento
P1234	4660	1234	Modulo Controlador Bomba combustible desconexión línea	P1286	4742	1286	Impulso combustible - menor de lo previsto
P1235	4661	1235	Control bomba combustible - fuera de rango	P1287	4743	1287	Impulso combustible - mayor de lo previsto
P1236	4662	1236	Control bomba combustible - fuera de rango	P1288	4744	1288	Sensor temperatura culata - fuera de limites
P1237	4663	1237	Bomba combustible secundaria - circuito defectuoso	P1289	4745	1289	Sensor temperatura culata - señal entrada alta
P1238	4664	1238	Bomba combustible secundaria - circuito defectuoso	P1290	4752	1290	Sensor temperatura culata - señal entrada baja
P1239	4665	1239	Fallo velocidad bomba combustible	P1291	4753	1291	Inyector bloque 1 corto a masa o positivo
P1240	4672	1240	Sensor alimentación corriente	P1292	4754	1292	Inyector bloque 2 corto a masa o positivo
P1241	4673	1241	Sensor alimentación corriente - señal entrada baja	P1293	4755	1293	Inyector bloque 1 abierto
P1242	4674	1242	Sensor alimentación corriente - señal entrada alta	P1294	4756	1294	Inyector bloque 2 abierto
P1243	4675	1243	Fallo segunda bomba combustible o masa	P1295	4757	1295	Múltiples fallos bloque 1
P1244	4676	1244	Alternador - señal entrada alta	P1296	4758	1296	Múltiples fallos bloque 2
P1245	4677	1245	Alternador - señal entrada baja	P1297	4759	1297	Inyector cortado
P1246	4678	1246	Alternador	P1298	4760	1298	Fallo IDM
P1247	4679	1247	Presión turbo baja	P1299	4761	1299	Sensor temperatura culada - sistema protección activo
P1248	4680	1248	Presión turbo no detectada	P1300	4864	1300	Fallo calibración compresor
P1249	4681	1249	Válvula reglaje inyección - funcionamiento	P1301	4865	1301	Calibración compresor alta
P1250	4688	1250	Solenoide Bomba - circuito defectuoso	P1302	4866	1302	Calibración compresor baja

P1303	4867	1303	Fallo calibración EGR	P1382	4994	1382	Solenoide posición árbol levas (bloque 1) - circuito defectuoso
P1304	4868	1304	Calibración EGR alta	P1383	4995	1383	Actuador posición árbol levas (bloque 1) - encendido sobre retrasado
P1305	4869	1305	Calibración EGR baja	P1384	4996	1384	Solenoide A árbol levas - circuito defectuoso
P1306	4870	1306	Relé Kickdown forzado - fallo circuito	P1385	4997	1385	Solenoide B árbol levas - circuito defectuoso
P1307	4871	1307	Relé Kickdown mantenido - fallo circuito	P1386	4998	1386	Actuador posición árbol levas (bloque 2) - encendido sobre avanzado
P1308	4872	1308	Aire acondicionado - fallo circuito	P1387	4999	1387	Solenoide posición árbol levas (bloque 2) - circuito defectuoso
P1309	4873	1309	Fallo chip supervisor detonación	P1388	5000	1388	Actuador posición árbol levas (bloque 2) - encendido sobre retrasado
P1313	4883	1313	Fallo catalizador/detonación bloque 1	P1389	5001	1389	Bujías - señal baja
P1314	4884	1314	Fallo catalizador/detonación bloque 2	P1390	5008	1390	Conector codificación octano - circuito abierto
P1315	4885	1315	Detonación persistente	P1391	5009	1391	Bujías encendido (bloque 1) - señal baja
P1316	4886	1316	Circuito inyector/Códigos IDM	P1392	5010	1392	Bujías encendido (bloque 1) - señal alta
P1317	4887	1317	Circuito inyector/Códigos IDM	P1393	5011	1393	Bujías encendido (bloque 2) - señal baja
P1319	4889	1319	Sensor posición pistón reglaje inyección - circuito defectuoso	P1394	5012	1394	Bujías encendido (bloque 2) - señal alta
P1336	4918	1336	Sensor árbol levas - rango, funcionamiento	P1395	5013	1395	Fallo supervisor bujías (bloque 1)
P1340	4928	1340	Sensor posición árbol levas B - circuito defectuoso	P1396	5014	1396	Fallo supervisor bujías (bloque 2)
P1341	4929	1341	Sensor posición árbol levas B - rango, funcionamiento	P1397	5015	1397	Tensión alimentación fuera de rango
P1342	4930	1342	Sensor posición pedal acelerador A - rango, funcionamiento	P1398	5016	1398	Solenoide B árbol levas - señal alta
P1343	4931	1343	Sensor posición pedal acelerador B - rango, funcionamiento	P1399	5017	1399	Bujías encendido - señal alta
P1344	4932	1344	Sensor posición pedal acelerador C - rango, funcionamiento	P1400	5120	1400	Sensor presión recirculación gases escape - señal baja
P1345	4933	1345	Sensor posición árbol levas - circuito defectuoso	P1401	5121	1401	Sensor presión recirculación gases escape - señal alta
P1346	4934	1346	Sensor nivel combustible B - circuito defectuoso	P1402	5122	1402	Sistema recirculación gases escape EGR - orificio medición restringido
P1347	4935	1347	Sensor nivel combustible B - rango, funcionamiento	P1403	5123	1403	Sensor EGR - Diferencia control
P1348	4936	1348	Sensor nivel combustible B - señal baja	P1404	5124	1404	Temperatura aire inyección/Recirculación EGR
P1349	4937	1349	Sensor nivel combustible B - señal alta	P1405	5125	1405	Sensor EGR - tubo flexible delantero desconectado u obstruido
P1350	4944	1350	Sensor nivel combustible B - interrupción intermitente	P1406	5126	1406	Sensor EGR - tubo flexible trasero desconectado u obstruido
P1351	4945	1351	Monitor diagnosis encendido - circuito entrada defectuoso	P1407	5127	1407	Sensor EGR - No detecta flujo
P1352	4946	1352	Primario encendido A - circuito defectuoso	P1408	5128	1408	Recirculación gases escape - flujo fuera limites
P1353	4947	1353	Primario encendido B - circuito defectuoso	P1409	5129	1409	Solenoide recirculación gases escape - circuito defectuoso
P1354	4948	1354	Primario encendido C - circuito defectuoso	P1411	5137	1411	Inyección aire secundario - flujo bajo
P1355	4949	1355	Primario encendido D - circuito defectuoso	P1413	5139	1413	Supervisor inyección aire secundario - señal entrada baja
P1358	4952	1358	Monitor diagnosis encendido - señal fuera de limites	P1414	5140	1414	Supervisor inyección aire secundario - señal entrada alta
P1359	4953	1359	Sistema encendido, señal salida chispa - circuito defectuoso	P1415	5141	1415	Bomba Aire - circuito defectuoso
P1360	4960	1360	Secundario encendido A - circuito defectuoso	P1416	5142	1416	Entrada aire - circuito defectuoso
P1361	4961	1361	Control encendido - tensión baja	P1417	5143	1417	Entrada aire - circuito defectuoso
P1362	4962	1362	Secundario encendido C - circuito defectuoso	P1418	5144	1418	División aire 1 - circuito defectuoso
P1363	4963	1363	Secundario encendido D - circuito defectuoso	P1419	5145	1419	División aire 2 - circuito defectuoso
P1364	4964	1364	Primario encendido - circuito defectuoso	P1420	5152	1420	Sensor temperatura catalizador
P1365	4965	1365	Secundario encendido - circuito defectuoso	P1421	5153	1421	Catalizador - defectuoso
P1366	4966	1366	Componentes encendido	P1422	5154	1422	Encendido gases escape - Sensor temperatura
P1367	4967	1367	Componentes encendido	P1423	5155	1423	Encendido gases escape - prueba funcional
P1368	4968	1368	Componentes encendido	P1424	5156	1424	Encendido gases escape - bujía primaria
P1369	4969	1369	Testigo temperatura motor - circuito defectuoso	P1425	5157	1425	Encendido gases escape - bujía secundaria
P1370	4976	1370	Insuficiente incremento RPM	P1426	5158	1426	Encendido gases escape - señal MAF fuera de rango
P1371	4977	1371	Encendido cilindro 1 - fallo activación	P1427	5159	1427	Encendido gases escape - señal MAF cortocircuito
P1372	4978	1372	Encendido cilindro 2 - fallo activación	P1428	5160	1428	Encendido gases escape - señal MAF circuito abierto
P1373	4979	1373	Encendido cilindro 3 - fallo activación	P1429	5161	1429	Bomba aire eléctrica - primaria
P1374	4980	1374	Encendido cilindro 4 - fallo activación	P1430	5168	1430	Bomba aire eléctrica - secundaria
P1375	4981	1375	Encendido cilindro 5 - fallo activación	P1432	5170	1432	Calentador termostato motor - circuito defectuoso
P1376	4982	1376	Encendido cilindro 6 - fallo activación	P1433	5171	1433	Temperatura refrigerante aire acondicionado - señal baja
P1380	4992	1380	Detectada detonación	P1434	5172	1434	Temperatura refrigerante aire acondicionado - señal alta
P1381	4993	1381	Actuador posición árbol levas (bloque 1) - encendido sobre avanzado	P1435	5173	1435	Temperatura refrigerante aire acondicionado - rango, funcionamiento

P1436	5174	1436	Temperatura evaporador aire acondicionado - señal baja	P1491	5265	1491	Interruptor solenoide secundario - circuito defectuoso
P1437	5175	1437	Temperatura evaporador aire acondicionado - señal alta	P1492	5266	1492	Solenoide APLSOL - circuito defectuoso
P1438	5176	1438	Temperatura evaporador aire acondicionado - rango, funcionamiento	P1493	5267	1493	Solenoide RCNT - circuito defectuoso
P1439	5177	1439	Interruptor temperatura - circuito defectuoso	P1494	5268	1494	Solenoide SPCUT - circuito defectuoso
P1440	5184	1440	Válvula purga abierto	P1495	5269	1495	Solenoide TCSPL - circuito defectuoso
P1441	5185	1441	Sistema emisión evaporaciones	P1500	5376	1500	Sensor velocidad vehículo
P1442	5186	1442	Control emisión evaporaciones	P1501	5377	1501	Sensor velocidad vehículo - fuera de límites
P1443	5187	1443	Válvula control emisión evaporaciones	P1502	5378	1502	Sensor velocidad vehículo - interrupción intermitente
P1444	5188	1444	Sensor purga flujo - señal baja	P1503	5379	1503	Sensor velocidad auxiliar
P1445	5189	1445	Sensor purga flujo - señal alta	P1504	5380	1504	Válvula control aire ralentí - circuito defectuoso
P1446	5190	1446	Solenoide evaporaciones - circuito defectuoso	P1505	5381	1505	Adaptación control aire ralentí
P1447	5191	1447	Válvula ELC	P1506	5382	1506	Válvula control aire ralentí - error sobre velocidad
P1448	5192	1448	Fallo sistema ELC	P1507	5383	1507	Válvula control aire ralentí - error infra velocidad
P1449	5193	1449	Solenoide chequeo evaporaciones - circuito defectuoso	P1508	5384	1508	Solenoide subida ralentí 1 - circuito abierto
P1450	5200	1450	Deposito combustible	P1509	5385	1509	Control ralentí - cortocircuito
P1451	5201	1451	Válvula control emisiones evaporación	P1510	5392	1510	Señal ralentí - circuito defectuoso
P1452	5202	1452	Deposito combustible	P1511	5393	1511	Interruptor ralentí, mariposa electrónica - circuito defectuoso
P1453	5203	1453	Válvula presión deposito combustible	P1512	5394	1512	Control aire colector admisión (bloque 1) - cerrado
P1454	5204	1454	Prueba sistema evaporaciones - circuito defectuoso	P1513	5395	1513	Control aire colector admisión (bloque 2) - cerrado
P1455	5205	1455	Control emisión evaporaciones	P1514	5396	1514	Fallo controlador
P1456	5206	1456	Sensor temperatura deposito combustible - circuito defectuoso	P1515	5397	1515	Corriente eléctrica - circuito defectuoso
P1457	5207	1457	Imposible forzar aspiración en depósito combustible	P1516	5398	1516	Solenoide aire colector admisión (bloque 1) - error señal entrada
P1460	5216	1460	Señal mariposa plena carga (corte A/C) - circuito defectuoso	P1517	5399	1517	Solenoide aire colector admisión (bloque 2) - error señal entrada
P1461	5217	1461	Sensor presión aire acondicionado - tensión baja	P1518	5400	1518	Control aire colector admisión - abierto
P1462	5218	1462	Sensor presión aire acondicionado - tensión alta	P1519	5401	1519	Control aire colector admisión - cerrado
P1463	5219	1463	Sensor presión aire acondicionado - presión insuficiente	P1520	5408	1520	Solenoide control aire colector admisión - circuito defectuoso
P1464	5220	1464	Petición aire acondicionado fuera límites diagnosis	P1521	5409	1521	Solenoide control aire colector admisión (bloque 1) - circuito defectuoso
P1465	5221	1465	Relé aire acondicionado - circuito defectuoso	P1522	5410	1522	Solenoide control aire colector admisión (bloque 2) - circuito defectuoso
P1466	5222	1466	Sensor temperatura refrigerante aire acondicionado - circuito defectuoso	P1523	5411	1523	Solenoide admisión variable - circuito defectuoso
P1467	5223	1467	Sensor temperatura compresor aire acondicionado - circuito defectuoso	P1524	5412	1524	Solenoid admission variable
P1468	5224	1468	Circuito abierto/cortocircuito SPOD	P1525	5413	1525	Volvuli aird bypass
P1469	5225	1469	Periodo reciclaje aire acondicionado bajo	P1526	5414	1526	Sistema aird bypass
P1470	5232	1470	Embrague compresor aire acondicionado - recorrido demasiado corto	P1527	5415	1527	Solenoide acelerador - circuito defectuoso
P1471	5233	1471	Fallo electro ventilador 1 (lado conductor)	P1528	5416	1528	Solenoide válvula mariposa auxiliar - circuito defectuoso
P1472	5234	1472	Fallo electro ventilador 2 (lado pasajero)	P1529	5417	1529	Solenoide SCAIR - circuito defectuoso
P1473	5235	1473	Ventilador secundario alto con ventiladores apagados	P1530	5424	1530	Circuito aire acondicionado
P1474	5236	1474	Ventilador - circuito defectuoso	P1531	5425	1531	Movimiento pedal acelerador
P1475	5237	1475	Relé ventiladores bajo - circuito defectuoso	P1532	5426	1532	Circuito IMCC (Bloque B) defectuoso
P1476	5238	1476	Relé ventiladores alto - circuito defectuoso	P1533	5427	1533	Circuito AAI defectuoso
P1477	5239	1477	Relé ventilador adicional - circuito defectuoso	P1534	5428	1534	Interruptor inercia activado
P1478	5240	1478	Ventilador refrigerante motor - fallo controlador	P1535	5429	1535	Velocidad ventilador - rango, funcionamiento
P1479	5241	1479	Ventilador refrigerante motor - circuito defectuoso	P1536	5430	1536	Interruptor freno aparcamiento - circuito defectuoso
P1480	5248	1480	Ventilador secundario bajo con ventiladores bajos encendidos	P1537	5431	1537	Control aire colector admisión (bloque 1) - abierto
P1481	5249	1481	Ventilador lento motor con ventilador rápido encendido	P1538	5432	1538	Control aire colector admisión (bloque 2) - abierto
P1482	5250	1482	Bomba combustible	P1539	5433	1539	Alimentación circuito aire acondicionado - sobre corriente
P1483	5251	1483	Alimentación ventiladores - sobre corriente	P1540	5440	1540	Válvula aire bypass - circuito defectuoso
P1484	5252	1484	Alimentación abierta a masa	P1549	5449	1549	Circuito IMCC (Bloque B) defectuoso
P1485	5253	1485	Calcula EGR - circuito defectuoso	P1550	5456	1550	PSPS fuera de rango
P1486	5254	1486	Actuador EGR - circuito defectuoso	P1563	5475	1563	Bomba inyección - petición parada motor
P1487	5255	1487	Solenoide EGR - circuito defectuoso	P1564	5476	1564	Bomba inyección - petición modo combustible reducido
P1490	5264	1490	Solenoide aire secundario - circuito defectuoso	P1565	5477	1565	Interruptor control velocidad - fuera de rango, alto

P1566	5478	1566	Interruptor control velocidad - fuera de rango, bajo	P1629	5673	1629	Modulo control motor - regulador interno tensión
P1567	5479	1567	Salida control velocidad - continuidad	P1630	5680	1630	Modulo control motor - tensión referencia interna
P1568	5480	1568	Control velocidad - imposible mantener velocidad	P1631	5681	1631	Relé control motor/Principal alimentación
P1571	5489	1571	Interruptor frenos - circuito defectuoso	P1632	5682	1632	Sensor avería alternador - circuito defectuoso
P1572	5490	1572	Interruptor pedal freno - circuito defectuoso	P1633	5683	1633	Tensión auxiliar - demasiado baja
P1573	5491	1573	Posición mariposa no disponible	P1634	5684	1634	Transmisión salida datos - circuito defectuoso
P1574	5492	1574	Sensor posición mariposa - contradicción entre sensores	P1635	5685	1635	Valores fuera de rango
P1575	5493	1575	Posición del pedal - fuera de rango	P1636	5686	1636	Error comunicación chip señal inductiva
P1576	5494	1576	Posición del pedal - no disponible	P1637	5687	1637	Comunicación motor-ABS defectuosa
P1577	5495	1577	Posición del pedal - contradicción entre sensores	P1638	5688	1638	Comunicación motor-cuadro instrumentos defectuoso
P1578	5496	1578	Alimentación ETC menor que exigida	P1639	5689	1639	Identificación vehículo errónea o no programada
P1579	5497	1579	Alimentación ETC al limite	P1640	5696	1640	Extracción averías disponible en otro modulo
P1580	5504	1580	Supervisor mariposa electrónica	P1641	5697	1641	Bomba combustible principal - circuito defectuoso
P1581	5505	1581	Supervisor mariposa electrónica - circuito defectuoso	P1642	5698	1642	Monitor bomba combustible - señal entrada alta
P1582	5506	1582	Supervisor mariposa electrónica - datos	P1643	5699	1643	Cableado circuito red módulos
P1583	5507	1583	Supervisor mariposa electrónica - cruceo desactivado	P1644	5700	1644	Control velocidad bomba combustible - circuito defectuoso
P1584	5508	1584	Unidad Control mariposa Detecta IPE - circuito defectuoso	P1645	5701	1645	Interruptor resistencia bomba combustible - circuito defectuoso
P1585	5509	1585	Unidad control mariposa - circuito defectuoso	P1650	5712	1650	Interruptor presión dirección asistida - fuera limites
P1586	5510	1586	Unidad control mariposa - posición mariposa defectuosa	P1651	5713	1651	Interruptor presión dirección asistida - señal entrada
P1587	5511	1587	Unidad control mariposa modulada - circuito defectuoso	P1652	5714	1652	Control Aire inyección desactivado
P1588	5512	1588	Unidad control mariposa detecta perdida de retorno	P1653	5715	1653	Tensión Alimentación salida defectuosa
P1589	5513	1589	Unidad control mariposa no puede controlar Angulo mariposa deseado	P1654	5716	1654	Recirculación defectuosa
P1600	5632	1600	Perdida alimentación corriente auxiliar	P1655	5717	1655	Arranque desactivado - circuito defectuoso
P1601	5633	1601	Error comunicaciones serie	P1658	5720	1658	Bomba inyección - tensión alimentación fuera rango
P1602	5634	1602	Modulo control inmovilizador - error comunicación	P1659	5721	1659	Bomba inyección - tensión alimentación
P1603	5635	1603	Memoria EEPROM defectuosa	P1660	5728	1660	Señal circuito salida alta
P1604	5636	1604	Código no registrado	P1661	5729	1661	Señal circuito salida baja
P1605	5637	1605	Fallo memoria permanente	P1662	5730	1662	Fallo circuito IDM_EN
P1606	5638	1606	Relé control O/P - circuito defectuoso	P1663	5731	1663	Señal petición combustible - circuito defectuoso
P1607	5639	1607	Testigo Averías O/P - circuito defectuoso	P1664	5732	1664	Bomba inyección - funcionamiento incorrecto
P1608	5640	1608	Señal control defectuosa	P1665	5733	1665	Bomba inyección - comunicación
P1609	5641	1609	Testigo averías - fallo controlador	P1666	5734	1666	Bomba inyección - sincronización sensor posición cigüeñal
P1610	5648	1610	Códigos interactivos SBDS	P1667	5735	1667	Circuito Control Inyección defectuoso
P1611	5649	1611	Códigos interactivos SBDS	P1668	5736	1668	Bomba inyección - perdida señal comunicación
P1612	5650	1612	Códigos interactivos SBDS	P1669	5737	1669	Bomba inyección - supervisión
P1613	5651	1613	Códigos interactivos SBDS	P1670	5744	1670	Señal electrónica no detectada
P1614	5652	1614	Códigos interactivos SBDS	P1680	5760	1680	Medición bomba aceite - defectuosa
P1615	5653	1615	Códigos interactivos SBDS	P1681	5761	1681	Medición bomba aceite - defectuosa
P1616	5654	1616	Códigos interactivos SBDS	P1682	5762	1682	Medición bomba aceite - defectuosa
P1617	5655	1617	Códigos interactivos SBDS	P1683	5763	1683	Sensor temperatura bomba aceite - circuito defectuoso
P1618	5656	1618	Códigos interactivos SBDS	P1684	5764	1684	Sensor posición bomba aceite - circuito defectuoso
P1619	5657	1619	Códigos interactivos SBDS	P1685	5765	1685	Motor paso a paso bomba aceite - circuito defectuoso
P1620	5664	1620	Códigos interactivos SBDS	P1686	5766	1686	Motor paso a paso bomba aceite - circuito defectuoso
P1621	5665	1621	Memoria UCE/Código inmovilizador no coinciden	P1687	5767	1687	Motor paso a paso bomba aceite - circuito defectuoso
P1622	5666	1622	Identificación inmovilizador no coincide	P1688	5768	1688	Motor paso a paso bomba aceite - circuito defectuoso
P1623	5667	1623	Código inmovilizador/identificador - fallo escritura	P1689	5769	1689	Solenoides control presión aceite - circuito defectuoso
P1624	5668	1624	Sistema antideslizamiento	P1690	5776	1690	Solenoides entrada - circuito defectuoso
P1625	5669	1625	Alimentación positivo a ventilador - circuito defectuoso	P1691	5777	1691	Solenoides control presión turbo - circuito defectuoso
P1626	5670	1626	Señal activado deslizamiento no recibida	P1692	5778	1692	Solenoides control turbo - circuito defectuoso
P1627	5671	1627	Modulo control motor - tensión alimentación fuera de rango	P1693	5779	1693	Control carga turbo - circuito defectuoso
P1628	5672	1628	Modulo control motor - tensión alimentación	P1694	5780	1694	Carga turbo - circuito defectuoso

P1695	5781	1695	Bus de datos CAN - datos bomba inyección	P1755	5973	1755	Sensor velocidad intermedio - circuito defectuoso
P1700	5888	1700	Transmisión - fallo en posición punto muerto	P1756	5974	1756	Solenoides cambio B - funcionamiento
P1701	5889	1701	Error reversible	P1760	5984	1760	Solenoides control presión A - cortocircuito
P1702	5890	1702	Circuito Transmisión - interrupción intermitente	P1761	5985	1761	Solenoides cambio C - funcionamiento
P1703	5891	1703	Interruptor posición pedal freno - fuera de límites	P1762	5986	1762	Fallo Margen superior
P1704	5892	1704	Fallo transición estados en Transmisión Digital	P1765	5989	1765	Solenoides reglaje inyección - circuito defectuoso
P1705	5893	1705	Interruptor marchas cortas/largas - sin función en P/N	P1767	5991	1767	Convertidor embrague rotativo - circuito defectuoso
P1706	5894	1706	Velocidad vehículo alta en aparcamiento	P1768	5992	1768	modo funcionamiento normal/invierno - circuito defectuoso
P1707	5895	1707	Fallo indicador punto muerto	P1769	5993	1769	Fallo modulación par transmisión (AG4)
P1708	5896	1708	Interruptor aire acondicionado - circuito defectuoso	P1770	6000	1770	Solenoides embrague - circuito defectuoso
P1709	5897	1709	Interruptor posición estacionamiento/punto muerto - fuera límites	P1775	6005	1775	Fallo testigo averías transmisión
P1711	5905	1711	sensor TFT fuera de rango	P1776	6006	1776	Fallo petición retardo encendido
P1712	5906	1712	Sistema reducción par transmisión - error señal	P1777	6007	1777	Fallo petición retardo encendido
P1713	5907	1713	Sensor TFT - Valor muy bajo	P1778	6008	1778	Transmisión I/P - circuito defectuoso
P1714	5908	1714	Señal inductiva SSA defectuosa	P1779	6009	1779	Circuito TCIL defectuoso
P1715	5909	1715	Señal inductiva SSB defectuosa	P1780	6016	1780	Interruptor control transmisión - fuera de rango
P1716	5910	1716	Señal Inductiva SSC defectuosa	P1781	6017	1781	Interruptor 4X4 - fuera de rango
P1717	5911	1717	Señal inductiva SSD defectuosa	P1782	6018	1782	Circuito P/ES fuera de rango
P1718	5912	1718	Sensor TFT - valor muy alto	P1783	6019	1783	Condición sobre temperatura en transmisión
P1720	5920	1720	Medidor velocidad vehículo - circuito defectuoso	P1784	6020	1784	Fallo mecánico en transmisión - Primera y Atrás
P1721	5921	1721	Marcha 1 incorrecta	P1785	6021	1785	Fallo mecánico en transmisión - Primera y Segunda
P1722	5922	1722	Marcha 2 incorrecta	P1786	6022	1786	Error cambio marchas 3-2
P1723	5923	1723	Marcha 3 incorrecta	P1787	6023	1787	Error cambio marchas 2-1
P1724	5924	1724	Marcha 4 incorrecta	P1788	6024	1788	Solenoides control presión B - circuito abierto
P1725	5925	1725	Insuficiente velocidad motor incrementada durante diagnosis	P1789	6025	1789	Solenoides control presión B - cortocircuito
P1726	5926	1726	Insuficiente velocidad motor decrementada durante diagnosis	P1790	6032	1790	Transmisión mecánica - circuito defectuoso
P1727	5927	1727	Señal inductiva solenoides aire acondicionado - circuito defectuoso	P1791	6033	1791	Transmisión eléctrica - circuito defectuoso
P1728	5928	1728	Error transmisión	P1792	6034	1792	Sensor presión barométrica - circuito defectuoso
P1729	5929	1729	Error Interruptor 4x4 bajo	P1793	6035	1793	Volumen aire admisión - circuito defectuoso
P1730	5936	1730	Control marchas 2, 3,5 - circuito defectuoso	P1794	6036	1794	Tensión batería
P1731	5937	1731	Cambio marchas 1-2 - circuito defectuoso	P1795	6037	1795	Interruptor ralentí - circuito defectuoso
P1732	5938	1732	Cambio marchas 2-3 - circuito defectuoso	P1796	6038	1796	Interruptor KickDown - circuito defectuoso
P1733	5939	1733	Cambio marchas 3-4 - circuito defectuoso	P1797	6039	1797	Interruptor punto muerto - circuito defectuoso
P1734	5940	1734	Control marchas - circuito defectuoso	P1798	6040	1798	Temperatura refrigerante - circuito defectuoso
P1735	5941	1735	Interruptor marcha primera - circuito defectuoso	P1799	6041	1799	Interruptor mantenido - circuito defectuoso
P1736	5942	1736	Interruptor marcha segunda - circuito defectuoso	P1800	6144	1800	Interruptor seguridad bloqueo embrague/transmisión - circuito defectuoso
P1737	5943	1737	Solenoides bloqueo sistema	P1801	6145	1801	Interruptor seguridad bloqueo embrague/transmisión - circuito abierto
P1738	5944	1738	Error tiempo cambio	P1802	6146	1802	Interruptor seguridad bloqueo embrague/transmisión - corto a positivo
P1739	5945	1739	Solenoides sistema	P1803	6147	1803	Interruptor seguridad bloqueo embrague/transmisión - corto a masa
P1740	5952	1740	Señal inductiva convertidor embrague rotativo - circuito defectuoso	P1804	6148	1804	Indicador transmisión alta 4 ruedas - circuito defectuoso
P1741	5953	1741	Error control convertidor embrague rotativo	P1805	6149	1805	Indicador transmisión alta 4 ruedas - circuito abierto
P1742	5954	1742	Fallo Solenoides convertidor embrague rotativo	P1806	6150	1806	Indicador transmisión alta 4 ruedas - corto a positivo
P1743	5955	1743	Fallo Solenoides convertidor embrague rotativo	P1807	6151	1807	Indicador transmisión alta 4 ruedas - corto a masa
P1744	5956	1744	Convertidor embrague rotativo - funcionamiento	P1808	6152	1808	Indicador transmisión baja 4 ruedas - circuito defectuoso
P1745	5957	1745	Solenoides presión sistema	P1809	6153	1809	Indicador transmisión baja 4 ruedas - circuito abierto
P1746	5958	1746	Solenoides control presión A - circuito abierto	P1810	6160	1810	Indicador transmisión baja 4 ruedas - corto a positivo
P1747	5959	1747	Solenoides control presión A - cortocircuito	P1811	6161	1811	Indicador transmisión baja 4 ruedas - corto a masa
P1748	5960	1748	EPC - circuito defectuoso	P1812	6162	1812	Modo selección transmisión 4 ruedas - circuito defectuoso
P1749	5961	1749	Solenoides control presión - fallo bajo	P1813	6163	1813	Modo selección transmisión 4 ruedas - circuito abierto
P1751	5969	1751	Solenoides cambio A - funcionamiento	P1814	6164	1814	Modo selección transmisión 4 ruedas - corto a positivo
P1754	5972	1754	Solenoides embrague - circuito defectuoso	P1815	6165	1815	Modo selección transmisión 4 ruedas - corto a masa

P1816	6166	1816	Interruptor seguridad transmisión punto muerto - circuito defectuoso	P1867	6247	1867	Contacto plata transferencia transmisión - circuito defectuoso
P1817	6167	1817	Interruptor seguridad transmisión punto muerto - circuito abierto	P1868	6248	1868	Testigo transmisión automática 4 ruedas - circuito defectuoso
P1818	6168	1818	Interruptor seguridad transmisión punto muerto - corto a positivo	P1869	6249	1869	Testigo transmisión automática 4 ruedas - corto a positivo
P1819	6169	1819	Interruptor seguridad transmisión punto muerto - corto a masa	P1870	6256	1870	Interruptor transferencia transmisión mecánica 4x4 - circuito defectuoso
P1820	6176	1820	Relé cambio transferencia transmisión - circuito defectuoso	P1871	6257	1871	Interruptor transferencia transmisión mecánica 4x4 - corto a positivo
P1821	6177	1821	Relé cambio transferencia transmisión - circuito abierto	P1872	6258	1872	Testigo bloqueo transmisión mecánica 4 ruedas - circuito defectuoso
P1822	6178	1822	Relé cambio transferencia transmisión - corto a positivo	P1873	6259	1873	Testigo bloqueo transmisión mecánica 4 ruedas - corto a positivo
P1823	6179	1823	Relé cambio transferencia transmisión - corto a masa	P1874	6260	1874	Sensor alimentación transmisión automática efecto Hall - circuito defectuoso
P1824	6180	1824	Relé embrague transmisión 4 ruedas - circuito defectuoso	P1875	6261	1875	Sensor alimentación transmisión automática efecto Hall - corto a positivo
P1825	6181	1825	Relé embrague transmisión 4 ruedas - circuito abierto	P1876	6262	1876	Solenoide transferencia transmisión 2 ruedas - circuito defectuoso
P1826	6182	1826	Relé embrague transmisión baja 4 ruedas - corto a positivo	P1877	6263	1877	Solenoide transferencia transmisión 2 ruedas - corto a positivo
P1827	6183	1827	Relé embrague transmisión baja 4 ruedas - corto a masa	P1878	6264	1878	Solenoide desenganche transferencia transmisión - circuito defectuoso
P1828	6184	1828	Relé cambio transferencia transmisión - circuito defectuoso	P1879	6265	1879	Solenoide desenganche transferencia transmisión - circuito abierto
P1829	6185	1829	Relé cambio transferencia transmisión - circuito abierto	P1880	6272	1880	Solenoide desenganche transferencia transmisión - corto a positivo
P1830	6192	1830	Relé cambio transferencia transmisión - corto a positivo	P1881	6273	1881	Interruptor nivel refrigerante motor - circuito defectuoso
P1831	6193	1831	Relé cambio transferencia transmisión - corto a masa	P1882	6274	1882	Interruptor nivel refrigerante motor - corto a masa
P1832	6194	1832	Solenoide bloqueo diferencial transferencia transmisión - circuito defectuoso	P1883	6275	1883	Interruptor nivel refrigerante motor - circuito defectuoso
P1833	6195	1833	Solenoide bloqueo diferencial transferencia transmisión - circuito abierto	P1884	6276	1884	Testigo Interruptor nivel refrigerante motor - corto a masa
P1834	6196	1834	Solenoide bloqueo diferencial transferencia transmisión - corto a positivo	P1885	6277	1885	Solenoide desenganche transferencia transmisión - corto a masa
P1835	6197	1835	Solenoide bloqueo diferencial transferencia transmisión - corto a masa	P1886	6278	1886	Fallo inicialización 4x4
P1836	6198	1836	Sensor velocidad frontal transferencia transmisión - circuito defectuoso	P1890	6288	1890	Selección modo transmisión 4WD - circuito defectuoso
P1837	6199	1837	Sensor velocidad lateral transferencia transmisión - circuito defectuoso	P1891	6289	1891	Contacto plata transferencia transmisión - circuito abierto
P1838	6200	1838	Motor cambio transferencia transmisión - circuito defectuoso	P1900	6400	1900	Circuito OSS - interrupción intermitente
P1839	6201	1839	Motor cambio transferencia transmisión - circuito abierto	P1901	6401	1901	Circuito TSS - Interrupción intermitente
P1840	6208	1840	Motor cambio transferencia transmisión - corto a positivo	P1902	6402	1902	Solenoide B Control presión - intermitente/corto
P1841	6209	1841	Motor cambio transferencia transmisión - corto a masa	P1903	6403	1903	Solenoide C Control presión - cortocircuito
P1842	6210	1842	Interruptor bloqueo diferencial transferencia transmisión - circuito defectuoso	P1904	6404	1904	Solenoide C Control presión - circuito abierto
P1843	6211	1843	Interruptor bloqueo diferencial transferencia transmisión - circuito abierto	P1905	6405	1905	Solenoide C Control presión - intermitente/corto
P1844	6212	1844	Interruptor bloqueo diferencial transferencia transmisión - corto a positivo	P1906	6406	1906	Relé kickdown forzado circuito abierto/cortocircuito masa
P1845	6213	1845	Interruptor bloqueo diferencial transferencia transmisión - corto a masa	P1907	6407	1907	Relé kickdown mantenido circuito abierto/cortocircuito masa
P1846	6214	1846	Contacto plata A transferencia transmisión Transmission - circuito defectuoso	P1908	6408	1908	Solenoide presión aceite transmisión - abierto/cortocircuito a masa
P1847	6215	1847	Contacto plata A transferencia transmisión Transmission - circuito abierto	P1909	6409	1909	Sensor temperatura aceite transmisión - abierto/cortocircuito a masa
P1848	6216	1848	Contacto plata A transferencia transmisión Transmission - corto a positivo	P1910	6416	1910	Fallo salida presión VFS A baja
P1849	6217	1849	Contacto plata A transferencia transmisión Transmission - corto a masa	P1911	6417	1911	Fallo salida presión VFS B baja
P1850	6224	1850	Contacto plata B transferencia transmisión Transmission - circuito defectuoso	P1912	6418	1912	Fallo salida presión VFS C baja
P1851	6225	1851	Contacto plata B transferencia transmisión Transmission - circuito abierto	P1913	6419	1913	Interruptor A presión - circuito defectuoso
P1852	6226	1852	Contacto plata B transferencia transmisión Transmission - corto a positivo	P1914	6420	1914	Interruptor cambio Automático/Manual - circuito defectuoso
P1853	6227	1853	Contacto plata B transferencia transmisión Transmission - corto a masa	P1915	6421	1915	Interruptor marcha atrás - circuito defectuoso
P1854	6228	1854	Contacto plata C transferencia transmisión Transmission - circuito defectuoso	P1916	6422	1916	Sensor velocidad altura cilindro embrague - circuito defectuoso
P1855	6229	1855	Contacto plata C transferencia transmisión Transmission - circuito abierto	P1917	6423	1917	Sensor velocidad altura cilindro embrague - interrupción intermitente
P1856	6230	1856	Contacto plata C transferencia transmisión Transmission - corto a positivo	P1918	6424	1918	Display rango transmisión - circuito defectuoso
P1857	6231	1857	Contacto plata C transferencia transmisión Transmission - corto a masa	P2000	8192	2000	Filtro óxidos nitrógeno
P1858	6232	1858	Contacto plata D transferencia transmisión Transmission - circuito defectuoso	P2001	8193	2001	NOx Trap Efficiency Below Threshold (Bank 2)
P1859	6233	1859	Contacto plata D transferencia transmisión Transmission - circuito abierto	P2002	8194	2002	Particulate Trap Efficiency Below Threshold (Bank 1)
P1860	6240	1860	Contacto plata D transferencia transmisión Transmission - corto a positivo	P2003	8195	2003	Particulate Trap Efficiency Below Threshold (Bank 2)
P1861	6241	1861	Contacto plata D transferencia transmisión Transmission - corto a masa	P2004	8196	2004	Intake Manifold Runner Control Stuck Open (Bank 1)
P1862	6242	1862	Alimentación contacto plata transferencia transmisión - circuito defectuoso	P2005	8197	2005	Intake Manifold Runner Control Stuck Open (Bank 2)
P1863	6243	1863	Alimentación contacto plata transferencia transmisión - circuito abierto	P2006	8198	2006	Intake Manifold Runner Control Stuck Closed (Bank 1)
P1864	6244	1864	Alimentación contacto plata transferencia transmisión - corto a positivo	P2007	8199	2007	Intake Manifold Runner Control Stuck Closed (Bank 2)
P1865	6245	1865	Alimentación contacto plata transferencia transmisión - corto a masa	P2008	8200	2008	Solenoide control aire colector admisión
P1866	6246	1866	Transferencia transmisión - servicio requerido	P2009	8201	2009	Solenoide control aire colector admisión - señal baja

P2010	8208	2010	Solenoid control aire colector admisión - señal alta	P2056	8278	2056	Reductant Injector Circuit/Open (Bank 2 Unit 2)
P2011	8209	2011	Intake Manifold Runner Control Circuit/Open (Bank 2)	P2057	8279	2057	Reductant Injector Circuit Low (Bank 2 Unit 2)
P2012	8210	2012	Intake Manifold Runner Control Circuit Low (Bank 2)	P2058	8280	2058	Reductant Injector Circuit High (Bank 2 Unit 2)
P2013	8211	2013	Intake Manifold Runner Control Circuit High (Bank 2)	P2059	8281	2059	Reductant Injection Air Pump Control Circuit/Open
P2014	8212	2014	Intake Manifold Runner Position Sensor/Switch Circuit (Bank 1)	P2060	8288	2060	Reductant Injection Air Pump Control Circuit Low
P2015	8213	2015	Intake Manifold Runner Position Sensor/Switch Circuit Range/Performance (Bank 1)	P2061	8289	2061	Reductant Injection Air Pump Control Circuit High
P2016	8214	2016	Intake Manifold Runner Position Sensor/Switch Circuit Low (Bank 1)	P2062	8290	2062	Reductant Supply Control Circuit/Open
P2017	8215	2017	Intake Manifold Runner Position Sensor/Switch Circuit High (Bank 1)	P2063	8291	2063	Reductant Supply Control Circuit Low
P2018	8216	2018	Intake Manifold Runner Position Sensor/Switch Circuit Intermittent (Bank 1)	P2064	8292	2064	Reductant Supply Control Circuit High
P2019	8217	2019	Intake Manifold Runner Position Sensor/Switch Circuit (Bank 2)	P2065	8293	2065	Fuel Level Sensor "B" Circuit
P2020	8224	2020	Intake Manifold Runner Position Sensor/Switch Circuit Range/Performance (Bank 2)	P2066	8294	2066	Fuel Level Sensor "B" Performance
P2021	8225	2021	Intake Manifold Runner Position Sensor/Switch Circuit Low (Bank 2)	P2067	8295	2067	Fuel Level Sensor "B" Circuit Low
P2022	8226	2022	Intake Manifold Runner Position Sensor/Switch Circuit High (Bank 2)	P2068	8296	2068	Fuel Level Sensor "B" Circuit High
P2023	8227	2023	Intake Manifold Runner Position Sensor/Switch Circuit Intermittent (Bank 2)	P2069	8297	2069	Fuel Level Sensor "B" Circuit Intermittent
P2024	8228	2024	Evaporative Emissions (EVAP) Fuel Vapor Temperature Sensor Circuit	P2070	8304	2070	Intake Manifold Tuning (IMT) Valve Stuck Open
P2025	8229	2025	Evaporative Emissions (EVAP) Fuel Vapor Temperature Sensor Performance	P2071	8305	2071	Intake Manifold Tuning (IMT) Valve Stuck Closed
P2026	8230	2026	Evaporative Emissions (EVAP) Fuel Vapor Temperature Sensor Circuit Low	P2075	8309	2075	Intake Manifold Tuning (IMT) Valve Position Sensor/Switch Circuit
P2027	8231	2027	Evaporative Emissions (EVAP) Fuel Vapor Temperature Sensor Circuit High	P2076	8310	2076	Intake Manifold Tuning (IMT) Valve Position Sensor/Switch Circuit Range/Performance
P2028	8232	2028	Evaporative Emissions (EVAP) Fuel Vapor Temperature Sensor Circuit Intermittent	P2077	8311	2077	Intake Manifold Tuning (IMT) Valve Position Sensor/Switch Circuit Low
P2029	8233	2029	Fuel Fired Heater Disabled	P2078	8312	2078	Intake Manifold Tuning (IMT) Valve Position Sensor/Switch Circuit High
P2030	8240	2030	Fuel Fired Heater Performance	P2079	8313	2079	Intake Manifold Tuning (IMT) Valve Position Sensor/Switch Circuit Intermittent
P2031	8241	2031	Exhaust Gas Temperature Sensor Circuit (Bank 1 Sensor 2)	P2080	8320	2080	Exhaust Gas Temperature Sensor Circuit Range/Performance (Bank 1 Sensor 1)
P2032	8242	2032	Exhaust Gas Temperature Sensor Circuit Low (Bank 1 Sensor 2)	P2081	8321	2081	Exhaust Gas Temperature Sensor Circuit Intermittent (Bank 1 Sensor 1)
P2033	8243	2033	Exhaust Gas Temperature Sensor Circuit High (Bank 1 Sensor 2)	P2082	8322	2082	Exhaust Gas Temperature Sensor Circuit Range/Performance (Bank 2 Sensor 1)
P2034	8244	2034	Exhaust Gas Temperature Sensor Circuit (Bank 2 Sensor 2)	P2083	8323	2083	Exhaust Gas Temperature Sensor Circuit Intermittent (Bank 2 Sensor 1)
P2035	8245	2035	Exhaust Gas Temperature Sensor Circuit Low (Bank 2 Sensor 2)	P2084	8324	2084	Exhaust Gas Temperature Sensor Circuit Range/Performance (Bank 1 Sensor 2)
P2036	8246	2036	Exhaust Gas Temperature Sensor Circuit High (Bank 2 Sensor 2)	P2085	8325	2085	Exhaust Gas Temperature Sensor Circuit Intermittent (Bank 1 Sensor 2)
P2037	8247	2037	Inyección Aire secundario, sensor presión - circuito defectuoso	P2086	8326	2086	Exhaust Gas Temperature Sensor Circuit Range/Performance (Bank 2 Sensor 2)
P2038	8248	2038	Reductant Injection Air Pressure Sensor Circuit Range/Performance	P2087	8327	2087	Exhaust Gas Temperature Sensor Circuit Intermittent (Bank 2 Sensor 2)
P2039	8249	2039	Reductant Injection Air Pressure Sensor Circuit Low Input	P2088	8328	2088	A Camshaft Position Actuator Control Circuit Low (Bank 1)
P2040	8256	2040	Reductant Injection Air Pressure Sensor Circuit High Input	P2089	8329	2089	A Camshaft Position Actuator Control Circuit High (Bank 1)
P2041	8257	2041	Reductant Injection Air Pressure Sensor Circuit Intermittent	P2090	8336	2090	B Camshaft Position Actuator Control Circuit Low (Bank 1)
P2042	8258	2042	Reductant Temperature Sensor Circuit	P2091	8337	2091	B Camshaft Position Actuator Control Circuit High (Bank 1)
P2043	8259	2043	Reductant Temperature Sensor Circuit Range/Performance	P2092	8338	2092	A Camshaft Position Actuator Control Circuit Low (Bank 2)
P2044	8260	2044	Reductant Temperature Sensor Circuit Low Input	P2093	8339	2093	A Camshaft Position Actuator Control Circuit High (Bank 2)
P2045	8261	2045	Reductant Temperature Sensor Circuit High Input	P2094	8340	2094	B Camshaft Position Actuator Control Circuit Low (Bank 2)
P2046	8262	2046	Reductant Temperature Sensor Circuit Intermittent	P2095	8341	2095	B Camshaft Position Actuator Control Circuit High (Bank 2)
P2047	8263	2047	Inyección Aire secundario (bloque 1 unidad 1) - circuito defectuoso	P2096	8342	2096	Post Catalyst Fuel Trim System Too Lean (Bank 1)
P2048	8264	2048	Reductant Injector Circuit Low (Bank 1 Unit 1)	P2097	8343	2097	Post Catalyst Fuel Trim System Too Rich (Bank 1)
P2049	8265	2049	Reductant Injector Circuit High (Bank 1 Unit 1)	P2098	8344	2098	Post Catalyst Fuel Trim System Too Lean (Bank 2)
P2050	8272	2050	Reductant Injector Circuit/Open (Bank 2 Unit 1)	P2099	8345	2099	Post Catalyst Fuel Trim System Too Rich (Bank 2)
P2051	8273	2051	Reductant Injector Circuit Low (Bank 2 Unit 1)	P2100	8448	2100	Throttle Actuator Control Motor Circuit/Open
P2052	8274	2052	Reductant Injector Circuit High (Bank 2 Unit 1)	P2101	8449	2101	Throttle Actuator Control Motor Circuit Range/Performance
P2053	8275	2053	Inyección Aire secundario (bloque 1 unidad 2) - circuito defectuoso	P2102	8450	2102	Throttle Actuator Control Motor Circuit Low
P2054	8276	2054	Reductant Injector Circuit Low (Bank 1 Unit 2)	P2103	8451	2103	Throttle Actuator Control Motor Circuit High
P2055	8277	2055	Reductant Injector Circuit High (Bank 1 Unit 2)	P2104	8452	2104	Throttle Actuator Control System - Forced Idle
				P2105	8453	2105	Throttle Actuator Control System - Forced Engine Shutdown
				P2106	8454	2106	Throttle Actuator Control System - Forced Limited Power
				P2107	8455	2107	Throttle Actuator Control Module Processor
				P2108	8456	2108	Throttle Actuator Control Module Performance

P2109	8457	2109	Throttle/Pedal Position Sensor "A" Minimum Stop Performance	P2160	8544	2160	Vehicle Speed Sensor "B" Circuit Low
P2110	8464	2110	Throttle Actuator Control System - Forced Limited RPM	P2161	8545	2161	Vehicle Speed Sensor "B" Intermittent/Erratic
P2111	8465	2111	Throttle Actuator Control System - Stuck Open	P2162	8546	2162	Vehicle Speed Sensor "A" / "B" Correlation
P2112	8466	2112	Throttle Actuator Control System - Stuck Closed	P2163	8547	2163	Throttle/Pedal Position Sensor "A" Maximum Stop Performance
P2113	8467	2113	Throttle/Pedal Position Sensor "B" Minimum Stop Performance	P2164	8548	2164	Throttle/Pedal Position Sensor "B" Maximum Stop Performance
P2114	8468	2114	Throttle/Pedal Position Sensor "C" Minimum Stop Performance	P2165	8549	2165	Throttle/Pedal Position Sensor "C" Maximum Stop Performance
P2115	8469	2115	Throttle/Pedal Position Sensor "D" Minimum Stop Performance	P2166	8550	2166	Throttle/Pedal Position Sensor "D" Maximum Stop Performance
P2116	8470	2116	Throttle/Pedal Position Sensor "E" Minimum Stop Performance	P2167	8551	2167	Throttle/Pedal Position Sensor "E" Maximum Stop Performance
P2117	8471	2117	Throttle/Pedal Position Sensor "F" Minimum Stop Performance	P2168	8552	2168	Throttle/Pedal Position Sensor "F" Maximum Stop Performance
P2118	8472	2118	Throttle Actuator Control Motor Current Range/Performance	P2169	8553	2169	Exhaust Pressure Regulator Vent Solenoid Control Circuit/Open
P2119	8473	2119	Throttle Actuator Control Throttle Body Range/Performance	P2170	8560	2170	Exhaust Pressure Regulator Vent Solenoid Control Circuit Low
P2120	8480	2120	Sensor/Interruptor posición pedal acelerador D - circuito defectuoso	P2171	8561	2171	Exhaust Pressure Regulator Vent Solenoid Control Circuit High
P2121	8481	2121	Throttle/Pedal Position Sensor/Switch "D" Circuit Range/Performance	P2172	8562	2172	Throttle Actuator Control System – Sudden High Airflow Detected
P2122	8482	2122	Throttle/Pedal Position Sensor/Switch "D" Circuit Low Input	P2173	8563	2173	Throttle Actuator Control System – High Airflow Detected
P2123	8483	2123	Throttle/Pedal Position Sensor/Switch "D" Circuit High Input	P2174	8564	2174	Throttle Actuator Control System – Sudden Low Airflow Detected
P2124	8484	2124	Throttle/Pedal Position Sensor/Switch "D" Circuit Intermittent	P2175	8565	2175	Throttle Actuator Control System – Low Airflow Detected
P2125	8485	2125	Sensor/Interruptor posición pedal acelerador E - circuito defectuoso	P2176	8566	2176	Throttle Actuator Control System – Idle Position Not Learned
P2126	8486	2126	Throttle/Pedal Position Sensor/Switch "E" Circuit Range/Performance	P2177	8567	2177	System Too Lean Off Idle (Bank 1)
P2127	8487	2127	Throttle/Pedal Position Sensor/Switch "E" Circuit Low Input	P2178	8568	2178	System Too Rich Off Idle (Bank 1)
P2128	8488	2128	Throttle/Pedal Position Sensor/Switch "E" Circuit High Input	P2179	8569	2179	System Too Lean Off Idle (Bank 2)
P2129	8489	2129	Throttle/Pedal Position Sensor/Switch "E" Circuit Intermittent	P2180	8576	2180	System Too Rich Off Idle (Bank 2)
P2130	8496	2130	Throttle/Pedal Position Sensor/Switch "F" Circuit	P2181	8577	2181	Cooling System Performance
P2131	8497	2131	Throttle/Pedal Position Sensor/Switch "F" Circuit Range Performance	P2182	8578	2182	Engine Coolant Temperature Sensor 2 Circuit
P2132	8498	2132	Throttle/Pedal Position Sensor/Switch "F" Circuit Low Input	P2183	8579	2183	Engine Coolant Temperature Sensor 2 Circuit Range/Performance
P2133	8499	2133	Throttle/Pedal Position Sensor/Switch "F" Circuit High Input	P2184	8580	2184	Engine Coolant Temperature Sensor 2 Circuit Low
P2134	8500	2134	Throttle/Pedal Position Sensor/Switch "F" Circuit Intermittent	P2185	8581	2185	Engine Coolant Temperature Sensor 2 Circuit High
P2135	8501	2135	Throttle/Pedal Position Sensor/Switch "A" / "B" Voltage Correlation	P2186	8582	2186	Engine Coolant Temperature Sensor 2 Circuit Intermittent/Erratic
P2136	8502	2136	Throttle/Pedal Position Sensor/Switch "A" / "C" Voltage Correlation	P2187	8583	2187	System Too Lean at Idle (Bank 1)
P2137	8503	2137	Throttle/Pedal Position Sensor/Switch "B" / "C" Voltage Correlation	P2188	8584	2188	System Too Rich at Idle (Bank 1)
P2138	8504	2138	Throttle/Pedal Position Sensor/Switch "D" / "E" Voltage Correlation	P2189	8585	2189	System Too Lean at Idle (Bank 2)
P2139	8505	2139	Throttle/Pedal Position Sensor/Switch "D" / "F" Voltage Correlation	P2190	8592	2190	System Too Rich at Idle (Bank 2)
P2140	8512	2140	Throttle/Pedal Position Sensor/Switch "E" / "F" Voltage Correlation	P2191	8593	2191	System Too Lean at Higher Load (Bank 1)
P2141	8513	2141	Exhaust Gas Recirculation Throttle Control Circuit Low	P2192	8594	2192	System Too Rich at Higher Load (Bank 1)
P2142	8514	2142	Exhaust Gas Recirculation Throttle Control Circuit High	P2193	8595	2193	System Too Lean at Higher Load (Bank 2)
P2143	8515	2143	Exhaust Gas Recirculation Vent Control Circuit/Open	P2194	8596	2194	System Too Rich at Higher Load (Bank 2)
P2144	8516	2144	Exhaust Gas Recirculation Vent Control Circuit Low	P2195	8597	2195	O2 Sensor Signal Stuck Lean (Bank 1 Sensor 1)
P2145	8517	2145	Exhaust Gas Recirculation Vent Control Circuit High	P2196	8598	2196	O2 Sensor Signal Stuck Rich (Bank 1 Sensor 1)
P2146	8518	2146	Fuel Injector Group "A" Supply Voltage Circuit/Open	P2197	8599	2197	O2 Sensor Signal Stuck Lean (Bank 2 Sensor 1)
P2147	8519	2147	Fuel Injector Group "A" Supply Voltage Circuit Low	P2198	8600	2198	O2 Sensor Signal Stuck Rich (Bank 2 Sensor 1)
P2148	8520	2148	Fuel Injector Group "A" Supply Voltage Circuit High	P2199	8601	2199	Intake Air Temperature Sensor 1 / 2 Correlation
P2149	8521	2149	Fuel Injector Group "B" Supply Voltage Circuit/Open	P2200	8704	2200	NOx Sensor Circuit (Bank 1)
P2150	8528	2150	Fuel Injector Group "B" Supply Voltage Circuit Low	P2201	8705	2201	NOx Sensor Circuit Range/Performance (Bank 1)
P2151	8529	2151	Fuel Injector Group "B" Supply Voltage Circuit High	P2202	8706	2202	NOx Sensor Circuit Low Input (Bank 1)
P2152	8530	2152	Fuel Injector Group "C" Supply Voltage Circuit/Open	P2203	8707	2203	NOx Sensor Circuit High Input (Bank 1)
P2153	8531	2153	Fuel Injector Group "C" Supply Voltage Circuit Low	P2204	8708	2204	NOx Sensor Circuit Intermittent Input (Bank 1)
P2154	8532	2154	Fuel Injector Group "C" Supply Voltage Circuit High	P2205	8709	2205	NOx Sensor Heater Control Circuit/Open (Bank 1)
P2155	8533	2155	Fuel Injector Group "D" Supply Voltage Circuit/Open	P2206	8710	2206	NOx Sensor Heater Control Circuit Low (Bank 1)
P2156	8534	2156	Fuel Injector Group "D" Supply Voltage Circuit Low	P2207	8711	2207	NOx Sensor Heater Control Circuit High (Bank 1)
P2157	8535	2157	Fuel Injector Group "D" Supply Voltage Circuit High	P2208	8712	2208	NOx Sensor Heater Sense Circuit (Bank 1)
P2158	8536	2158	Vehicle Speed Sensor "B"	P2209	8713	2209	NOx Sensor Heater Sense Circuit Range/Performance (Bank 1)
P2159	8537	2159	Vehicle Speed Sensor "B" Range/Performance	P2210	8720	2210	NOx Sensor Heater Sense Circuit Low Input (Bank 1)



P2211	8721	2211	NOx Sensor Heater Sense Circuit High Input (Bank 1)	P2262	8802	2262	Turbo Boost Pressure Not Detected - Mechanical
P2212	8722	2212	NOx Sensor Heater Sense Circuit Intermittent (Bank 1)	P2263	8803	2263	Turbo/Super Charger Boost System Performance
P2213	8723	2213	NOx Sensor Circuit (Bank 2)	P2264	8804	2264	Water in Fuel Sensor Circuit
P2214	8724	2214	NOx Sensor Circuit Range/Performance (Bank 2)	P2265	8805	2265	Water in Fuel Sensor Circuit Range/Performance
P2215	8725	2215	NOx Sensor Circuit Low Input (Bank 2)	P2266	8806	2266	Water in Fuel Sensor Circuit Low
P2216	8726	2216	NOx Sensor Circuit High Input (Bank 2)	P2267	8807	2267	Water in Fuel Sensor Circuit High
P2217	8727	2217	NOx Sensor Circuit Intermittent Input (Bank 2)	P2268	8808	2268	Water in Fuel Sensor Circuit Intermittent
P2218	8728	2218	NOx Sensor Heater Control Circuit/Open (Bank 2)	P2269	8809	2269	Water in Fuel Condition
P2219	8729	2219	NOx Sensor Heater Control Circuit Low (Bank 2)	P2270	8816	2270	O2 Sensor Signal Stuck Lean (Bank 1 Sensor 2)
P2220	8736	2220	NOx Sensor Heater Control Circuit High (Bank 2)	P2271	8817	2271	O2 Sensor Signal Stuck Rich (Bank 1 Sensor 2)
P2221	8737	2221	NOx Sensor Heater Sense Circuit (Bank 2)	P2272	8818	2272	O2 Sensor Signal Stuck Lean (Bank 2 Sensor 2)
P2222	8738	2222	NOx Sensor Heater Sense Circuit Range/Performance (Bank 2)	P2273	8819	2273	O2 Sensor Signal Stuck Rich (Bank 2 Sensor 2)
P2223	8739	2223	NOx Sensor Heater Sense Circuit Low (Bank 2)	P2274	8820	2274	O2 Sensor Signal Stuck Lean (Bank 1 Sensor 3)
P2224	8740	2224	NOx Sensor Heater Sense Circuit High (Bank 2)	P2275	8821	2275	O2 Sensor Signal Stuck Rich (Bank 1 Sensor 3)
P2225	8741	2225	NOx Sensor Heater Sense Circuit Intermittent (Bank 2)	P2276	8822	2276	O2 Sensor Signal Stuck Lean (Bank 2 Sensor 3)
P2226	8742	2226	Barometric Pressure Circuit	P2277	8823	2277	O2 Sensor Signal Stuck Rich (Bank 2 Sensor 3)
P2227	8743	2227	Barometric Pressure Circuit Range/Performance	P2278	8824	2278	O2 Sensor Signals Swapped Bank 1 Sensor 3 / Bank 2 Sensor 3
P2228	8744	2228	Barometric Pressure Circuit Low	P2279	8825	2279	Intake Air System Leak
P2229	8745	2229	Barometric Pressure Circuit High	P2280	8832	2280	Air Flow Restriction / Air Leak between Air Filter and MAF
P2230	8752	2230	Barometric Pressure Circuit Intermittent	P2281	8833	2281	Air Leak between MAF and Throttle Body
P2231	8753	2231	O2 Sensor Signal Circuit Shorted to Heater Circuit (Bank 1 Sensor 1)	P2282	8834	2282	Air Leak between Throttle Body and Intake Valves
P2232	8754	2232	O2 Sensor Signal Circuit Shorted to Heater Circuit (Bank 1 Sensor 2)	P2283	8835	2283	Injector Control Pressure Sensor Circuit
P2233	8755	2233	O2 Sensor Signal Circuit Shorted to Heater Circuit (Bank 1 Sensor 3)	P2284	8836	2284	Injector Control Pressure Sensor Circuit Range/Performance
P2234	8756	2234	O2 Sensor Signal Circuit Shorted to Heater Circuit (Bank 2 Sensor 1)	P2285	8837	2285	Injector Control Pressure Sensor Circuit Low
P2235	8757	2235	O2 Sensor Signal Circuit Shorted to Heater Circuit (Bank 2 Sensor 2)	P2286	8838	2286	Injector Control Pressure Sensor Circuit High
P2236	8758	2236	O2 Sensor Signal Circuit Shorted to Heater Circuit (Bank 2 Sensor 3)	P2287	8839	2287	Injector Control Pressure Sensor Circuit Intermittent
P2237	8759	2237	O2 Sensor Positive Current Circuit/Open (Bank 1 Sensor 1)	P2288	8840	2288	Inyector - presión control alta
P2238	8760	2238	O2 Sensor Positive Current Circuit Low (Bank 1 Sensor 1)	P2289	8841	2289	Injector Control Pressure Too High – Engine Off
P2239	8761	2239	O2 Sensor Positive Current Circuit High (Bank 1 Sensor 1)	P2290	8848	2290	Injector Control Pressure Too Low
P2240	8768	2240	O2 Sensor Positive Current Circuit/Open (Bank 2 Sensor 1)	P2291	8849	2291	Inyector - presión control baja durante arranque
P2241	8769	2241	O2 Sensor Positive Current Circuit Low (Bank 2 Sensor 1)	P2292	8850	2292	Injector Control Pressure Erratic
P2242	8770	2242	O2 Sensor Positive Current Circuit High (Bank 2 Sensor 1)	P2293	8851	2293	Fuel Pressure Regulator 2 Performance
P2243	8771	2243	O2 Sensor Reference Voltage Circuit/Open (Bank 1 Sensor 1)	P2294	8852	2294	Fuel Pressure Regulator 2 Control Circuit
P2244	8772	2244	O2 Sensor Reference Voltage Performance (Bank 1 Sensor 1)	P2295	8853	2295	Fuel Pressure Regulator 2 Control Circuit Low
P2245	8773	2245	O2 Sensor Reference Voltage Circuit Low (Bank 1 Sensor 1)	P2296	8854	2296	Fuel Pressure Regulator 2 Control Circuit High
P2246	8774	2246	O2 Sensor Reference Voltage Circuit High (Bank 1 Sensor 1)	P2297	8855	2297	O2 Sensor Out of Range during Deceleration (Bank 1 Sensor 1)
P2247	8775	2247	O2 Sensor Reference Voltage Circuit/Open (Bank 2 Sensor 1)	P2298	8856	2298	O2 Sensor Out of Range during Deceleration (Bank 2 Sensor 1)
P2248	8776	2248	O2 Sensor Reference Voltage Performance (Bank 2 Sensor 1)	P2299	8857	2299	Brake Pedal Position / Accelerator Pedal Position Incompatible
P2249	8777	2249	O2 Sensor Reference Voltage Circuit Low (Bank 2 Sensor 1)	P2300	8960	2300	Ignition Coil "A" Primary Control Circuit Low
P2250	8784	2250	O2 Sensor Reference Voltage Circuit High (Bank 2 Sensor 1)	P2301	8961	2301	Ignition Coil "A" Primary Control Circuit High
P2251	8785	2251	O2 Sensor Negative Current Control Circuit/Open (Bank 1 Sensor 1)	P2302	8962	2302	Ignition Coil "A" Secondary Circuit
P2252	8786	2252	O2 Sensor Negative Current Control Circuit Low (Bank 1 Sensor 1)	P2303	8963	2303	Ignition Coil "B" Primary Control Circuit Low
P2253	8787	2253	O2 Sensor Negative Current Control Circuit High (Bank 1 Sensor 1)	P2304	8964	2304	Ignition Coil "B" Primary Control Circuit High
P2254	8788	2254	O2 Sensor Negative Current Control Circuit/Open (Bank 2 Sensor 1)	P2305	8965	2305	Ignition Coil "B" Secondary Circuit
P2255	8789	2255	O2 Sensor Negative Current Control Circuit Low (Bank 2 Sensor 1)	P2306	8966	2306	Ignition Coil "C" Primary Control Circuit Low
P2256	8790	2256	O2 Sensor Negative Current Control Circuit High (Bank 2 Sensor 1)	P2307	8967	2307	Ignition Coil "C" Primary Control Circuit High
P2257	8791	2257	Secondary Air Injection System Control "A" Circuit Low	P2308	8968	2308	Ignition Coil "C" Secondary Circuit
P2258	8792	2258	Secondary Air Injection System Control "A" Circuit High	P2309	8969	2309	Ignition Coil "D" Primary Control Circuit Low
P2259	8793	2259	Secondary Air Injection System Control "B" Circuit Low	P2310	8976	2310	Ignition Coil "D" Primary Control Circuit High
P2260	8800	2260	Secondary Air Injection System Control "B" Circuit High	P2311	8977	2311	Ignition Coil "D" Secondary Circuit
P2261	8801	2261	Turbo/Super Charger Bypass Valve - Mechanical	P2312	8978	2312	Ignition Coil "E" Primary Control Circuit Low

P2313	8979	2313	Ignition Coil "E" Primary Control Circuit High	P2414	9236	2414	O2 Sensor Exhaust Sample Error (Bank 1 Sensor 1)
P2314	8980	2314	Ignition Coil "E" Secondary Circuit	P2415	9237	2415	O2 Sensor Exhaust Sample Error (Bank 2 Sensor 1)
P2315	8981	2315	Ignition Coil "F" Primary Control Circuit Low	P2416	9238	2416	O2 Sensor Signals Swapped Bank 1 Sensor 2 / Bank 1 Sensor 3
P2316	8982	2316	Ignition Coil "F" Primary Control Circuit High	P2417	9239	2417	O2 Sensor Signals Swapped Bank 2 Sensor 2 / Bank 2 Sensor 3
P2317	8983	2317	Ignition Coil "F" Secondary Circuit	P2418	9240	2418	Evaporative Emission System Switching Valve Control Circuit /Open
P2318	8984	2318	Ignition Coil "G" Primary Control Circuit Low	P2419	9241	2419	Evaporative Emission System Switching Valve Control Circuit Low
P2319	8985	2319	Ignition Coil "G" Primary Control Circuit High	P2420	9248	2420	Evaporative Emission System Switching Valve Control Circuit High
P2320	8992	2320	Ignition Coil "G" Secondary Circuit	P2421	9249	2421	Evaporative Emission System Vent Valve Stuck Open
P2321	8993	2321	Ignition Coil "H" Primary Control Circuit Low	P2422	9250	2422	Evaporative Emission System Vent Valve Stuck Closed
P2322	8994	2322	Ignition Coil "H" Primary Control Circuit High	P2423	9251	2423	HC Adsorption Catalyst Efficiency Below Threshold (Bank 1)
P2323	8995	2323	Ignition Coil "H" Secondary Circuit	P2424	9252	2424	HC Adsorption Catalyst Efficiency Below Threshold (Bank 2)
P2324	8996	2324	Ignition Coil "I" Primary Control Circuit Low	P2500	9472	2500	Generator Lamp/L-Terminal Circuit Low
P2325	8997	2325	Ignition Coil "I" Primary Control Circuit High	P2501	9473	2501	Generator Lamp/L-Terminal Circuit High
P2326	8998	2326	Ignition Coil "I" Secondary Circuit	P2502	9474	2502	Charging System Voltage
P2327	8999	2327	Ignition Coil "J" Primary Control Circuit Low	P2503	9475	2503	Charging System Voltage Low
P2328	9000	2328	Ignition Coil "J" Primary Control Circuit High	P2504	9476	2504	Charging System Voltage High
P2329	9001	2329	Ignition Coil "J" Secondary Circuit	P2505	9477	2505	ECM/PCM Power Input Signal
P2330	9008	2330	Ignition Coil "K" Primary Control Circuit Low	P2506	9478	2506	ECM/PCM Power Input Signal Range/Performance
P2331	9009	2331	Ignition Coil "K" Primary Control Circuit High	P2507	9479	2507	ECM/PCM Power Input Signal Low
P2332	9010	2332	Ignition Coil "K" Secondary Circuit	P2508	9480	2508	ECM/PCM Power Input Signal High
P2333	9011	2333	Ignition Coil "L" Primary Control Circuit Low	P2509	9481	2509	ECM/PCM Power Input Signal Intermittent
P2334	9012	2334	Ignition Coil "L" Primary Control Circuit High	P2510	9488	2510	ECM/PCM Power Relay Sense Circuit Range/Performance
P2335	9013	2335	Ignition Coil "L" Secondary Circuit	P2511	9489	2511	ECM/PCM Power Relay Sense Circuit Intermittent
P2336	9014	2336	Cilindro 1 - por encima umbral detonación	P2512	9490	2512	Event Data Recorder Request Circuit/ Open
P2337	9015	2337	Cilindro 2 - por encima umbral detonación	P2513	9491	2513	Event Data Recorder Request Circuit Low
P2338	9016	2338	Cilindro 3 - por encima umbral detonación	P2514	9492	2514	Event Data Recorder Request Circuit High
P2339	9017	2339	Cilindro 4 - por encima umbral detonación	P2515	9493	2515	A/C Refrigerant Pressure Sensor "B" Circuit
P2340	9024	2340	Cilindro 5 - por encima umbral detonación	P2516	9494	2516	A/C Refrigerant Pressure Sensor "B" Circuit Range/Performance
P2341	9025	2341	Cilindro 6 - por encima umbral detonación	P2517	9495	2517	A/C Refrigerant Pressure Sensor "B" Circuit Low
P2342	9026	2342	Cylinder #7 Above Knock Threshold	P2518	9496	2518	A/C Refrigerant Pressure Sensor "B" Circuit High
P2343	9027	2343	Cylinder #8 Above Knock Threshold	P2519	9497	2519	A/C Request "A" Circuit
P2344	9028	2344	Cylinder #9 Above Knock Threshold	P2520	9504	2520	A/C Request "A" Circuit Low
P2345	9029	2345	Cylinder #10 Above Knock Threshold	P2521	9505	2521	A/C Request "A" Circuit High
P2346	9030	2346	Cylinder #11 Above Knock Threshold	P2522	9506	2522	A/C Request "B" Circuit
P2347	9031	2347	Cylinder #12 Above Knock Threshold	P2523	9507	2523	A/C Request "B" Circuit Low
P2400	9216	2400	Evaporative Emission System Leak Detection Pump Control Circuit/Open	P2524	9508	2524	A/C Request "B" Circuit High
P2401	9217	2401	Evaporative Emission System Leak Detection Pump Control Circuit Low	P2525	9509	2525	Vacuum Reservoir Pressure Sensor Circuit
P2402	9218	2402	Evaporative Emission System Leak Detection Pump Control Circuit High	P2526	9510	2526	Vacuum Reservoir Pressure Sensor Circuit Range/Performance
P2403	9219	2403	Evaporative Emission System Leak Detection Pump Sense Circuit/Open	P2527	9511	2527	Vacuum Reservoir Pressure Sensor Circuit Low
P2404	9220	2404	Evaporative Emission System Leak Detection Pump Sense Circuit Range/Performance	P2528	9512	2528	Vacuum Reservoir Pressure Sensor Circuit High
P2405	9221	2405	Evaporative Emission System Leak Detection Pump Sense Circuit Low	P2529	9513	2529	Vacuum Reservoir Pressure Sensor Circuit Intermittent
P2406	9222	2406	Evaporative Emission System Leak Detection Pump Sense Circuit High	P2530	9520	2530	Ignition Switch Run Position Circuit
P2407	9223	2407	Evaporative Emission System Leak Detection Pump Sense Circuit Intermittent/Erratic	P2531	9521	2531	Ignition Switch Run Position Circuit Low
P2408	9224	2408	Fuel Cap Sensor/Switch Circuit	P2532	9522	2532	Ignition Switch Run Position Circuit High
P2409	9225	2409	Fuel Cap Sensor/Switch Circuit Range/Performance	P2533	9523	2533	Ignition Switch Run/Start Position Circuit
P2410	9232	2410	Fuel Cap Sensor/Switch Circuit Low	P2534	9524	2534	Ignition Switch Run/Start Position Circuit Low
P2411	9233	2411	Fuel Cap Sensor/Switch Circuit High	P2535	9525	2535	Ignition Switch Run/Start Position Circuit High
P2412	9234	2412	Fuel Cap Sensor/Switch Circuit Intermittent/Erratic	P2536	9526	2536	Ignition Switch Accessory Position Circuit
P2413	9235	2413	Exhaust Gas Recirculation System Performance	P2537	9527	2537	Ignition Switch Accessory Position Circuit Low
				P2538	9528	2538	Ignition Switch Accessory Position Circuit High
				P2539	9529	2539	Low Pressure Fuel System Sensor Circuit

P2540	9536	2540	Low Pressure Fuel System Sensor Circuit Range/Performance	P2630	9776	2630	O2 Sensor Pumping Current Trim Circuit Low (Bank 2 Sensor 1)
P2541	9537	2541	Low Pressure Fuel System Sensor Circuit Low	P2631	9777	2631	O2 Sensor Pumping Current Trim Circuit High (Bank 2 Sensor 1)
P2542	9538	2542	Low Pressure Fuel System Sensor Circuit High	P2632	9778	2632	Fuel Pump "B" Control Circuit /Open
P2543	9539	2543	Low Pressure Fuel System Sensor Circuit Intermittent	P2633	9779	2633	Fuel Pump "B" Control Circuit Low
P2544	9540	2544	Torque Management Request Input Signal "A"	P2634	9780	2634	Fuel Pump "B" Control Circuit High
P2545	9541	2545	Torque Management Request Input Signal "A" Range/Performance	P2635	9781	2635	Fuel Pump "A" Low Flow / Performance
P2546	9542	2546	Torque Management Request Input Signal "A" Low	P2636	9782	2636	Fuel Pump "B" Low Flow / Performance
P2547	9543	2547	Torque Management Request Input Signal "A" High	P2637	9783	2637	Torque Management Feedback Signal "A"
P2548	9544	2548	Torque Management Request Input Signal "B"	P2638	9784	2638	Torque Management Feedback Signal "A" Range/Performance
P2549	9545	2549	Torque Management Request Input Signal "B" Range/Performance	P2639	9785	2639	Torque Management Feedback Signal "A" Low
P2550	9552	2550	Torque Management Request Input "B" Signal Low	P2640	9792	2640	Torque Management Feedback Signal "A" High
P2551	9553	2551	Torque Management Request Input "B" Signal High	P2641	9793	2641	Torque Management Feedback Signal "B"
P2552	9554	2552	Throttle/Fuel Inhibit Circuit	P2642	9794	2642	Torque Management Feedback Signal "B" Range/Performance
P2553	9555	2553	Throttle/Fuel Inhibit Circuit Range/Performance	P2643	9795	2643	Torque Management Feedback Signal "B" Low
P2554	9556	2554	Throttle/Fuel Inhibit Circuit Low	P2644	9796	2644	Torque Management Feedback Signal "B" High
P2555	9557	2555	Throttle/Fuel Inhibit Circuit High	P2645	9797	2645	A Rocker Arm Actuator Control Circuit/Open (Bank 1)
P2556	9558	2556	Engine Coolant Level Sensor/Switch Circuit	P2646	9798	2646	A Rocker Arm Actuator System Performance or Stuck Off (Bank 1)
P2557	9559	2557	Engine Coolant Level Sensor/Switch Circuit Range/Performance	P2647	9799	2647	A Rocker Arm Actuator System S tuck On (Bank 1)
P2558	9560	2558	Engine Coolant Level Sensor/Switch Circuit Low	P2648	9800	2648	A Rocker Arm Actuator Control Circuit Low (Bank 1)
P2559	9561	2559	Engine Coolant Level Sensor/Switch Circuit High	P2649	9801	2649	A Rocker Arm Actuator Control Circuit High (Bank 1)
P2560	9568	2560	Engine Coolant Level Low	P2650	9808	2650	B Rocker Arm Actuator Control Circuit/Open (Bank 1)
P2600	9728	2600	Coolant Pump Control Circuit/Open	P2651	9809	2651	B Rocker Arm Actuator System Performance or Stuck Off (Bank 1)
P2601	9729	2601	Coolant Pump Control Circuit Range/Performance	P2652	9810	2652	B Rocker Arm Actuator System S tuck On (Bank 1)
P2602	9730	2602	Coolant Pump Control Circuit Low	P2653	9811	2653	B Rocker Arm Actuator Control Circuit Low (Bank 1)
P2603	9731	2603	Coolant Pump Control Circuit High	P2654	9812	2654	B Rocker Arm Actuator Control Circuit High (Bank 1)
P2604	9732	2604	Intake Air Heater "A" Circuit Range/Performance	P2655	9813	2655	A Rocker Arm Actuator Control Circuit/Open (Bank 2)
P2605	9733	2605	Intake Air Heater "A" Circuit/Open	P2656	9814	2656	A Rocker Arm Actuator System Performance or Stuck Off (Bank 2)
P2606	9734	2606	Intake Air Heater "B" Circuit Range/Performance	P2657	9815	2657	A Rocker Arm Actuator System S tuck On (Bank 2)
P2607	9735	2607	Intake Air Heater "B" Circuit Low	P2658	9816	2658	A Rocker Arm Actuator Control Circuit Low (Bank 2)
P2608	9736	2608	Intake Air Heater "B" Circuit High	P2659	9817	2659	A Rocker Arm Actuator Control Circuit High (Bank 2)
P2609	9737	2609	Intake Air Heater System Performance	P2660	9824	2660	B Rocker Arm Actuator Control Circuit/Open (Bank 2)
P2610	9744	2610	ECM/PCM Internal Engine Off Timer Performance	P2661	9825	2661	B Rocker Arm Actuator System Performance or Stuck Off (Bank 2)
P2611	9745	2611	A/C Refrigerant Distribution Valve Control Circuit/Open	P2662	9826	2662	B Rocker Arm Actuator System S tuck On (Bank 2)
P2612	9746	2612	A/C Refrigerant Distribution Valve Control Circuit Low	P2663	9827	2663	B Rocker Arm Actuator Control Circuit Low (Bank 2)
P2613	9747	2613	A/C Refrigerant Distribution Valve Control Circuit High	P2664	9828	2664	B Rocker Arm Actuator Control Circuit High (Bank 2)
P2614	9748	2614	Camshaft Position Signal Output Circuit/Open	P2700	9984	2700	Transmission Friction Element "A" Apply Time Range/Performance
P2615	9749	2615	Camshaft Position Signal Output Circuit Low	P2701	9985	2701	Transmission Friction Element "B" Apply Time Range/Performance
P2616	9750	2616	Camshaft Position Signal Output Circuit High	P2702	9986	2702	Transmission Friction Element "C" Apply Time Range/Performance
P2617	9751	2617	Crankshaft Position Signal Output Circuit/Open	P2703	9987	2703	Transmission Friction Element "D" Apply Time Range/Performance
P2618	9752	2618	Crankshaft Position Signal Output Circuit Low	P2704	9988	2704	Transmission Friction Element "E" Apply Time Range/Performance
P2619	9753	2619	Crankshaft Position Signal Output Circuit High	P2705	9989	2705	Transmission Friction Element "F" Apply Time Range/Performance
P2620	9760	2620	Throttle Position Output Circuit/Open	P2706	9990	2706	Shift Solenoid "F"
P2621	9761	2621	Throttle Position Output Circuit Low	P2707	9991	2707	Shift Solenoid "F" Performance or Stuck Off
P2622	9762	2622	Throttle Position Output Circuit High	P2708	9992	2708	Shift Solenoid "F" Stuck On
P2623	9763	2623	Injector Control Pressure Regulator Circuit/Open	P2709	9993	2709	Shift Solenoid "F" Electrical
P2624	9764	2624	Injector Control Pressure Regulator Circuit Low	P2710	10000	2710	Shift Solenoid "F" Intermittent
P2625	9765	2625	Injector Control Pressure Regulator Circuit High	P2711	10001	2711	Unexpected Mechanical Gear Disengagement
P2626	9766	2626	O2 Sensor Pumping Current Trim Circuit/Open (Bank 1 Sensor 1)	P2712	10002	2712	Hydraulic Power Unit Leakage
P2627	9767	2627	O2 Sensor Pumping Current Trim Circuit Low (Bank 1 Sensor 1)	P2713	10003	2713	Pressure Control Solenoid "D"
P2628	9768	2628	O2 Sensor Pumping Current Trim Circuit High (Bank 1 Sensor 1)	P2714	10004	2714	Pressure Control Solenoid "D" Performance or Stuck Off
P2629	9769	2629	O2 Sensor Pumping Current Trim Circuit/Open (Bank 2 Sensor 1)	P2715	10005	2715	Pressure Control Solenoid "D" Stuck On

P2716	10006	2716	Pressure Control Solenoid "D" Electrical	P2765	10085	2765	Input/Turbine Speed Sensor "B" Circuit
P2717	10007	2717	Pressure Control Solenoid "D" Intermittent	P2766	10086	2766	Input/Turbine Speed Sensor "B" Circuit Range/Performance
P2718	10008	2718	Pressure Control Solenoid "D" Control Circuit / Open	P2767	10087	2767	Input/Turbine Speed Sensor "B" Circuit No Signal
P2719	10009	2719	Pressure Control Solenoid "D" Control Circuit Range/Performance	P2768	10088	2768	Input/Turbine Speed Sensor "B" Circuit Intermittent
P2720	10016	2720	Pressure Control Solenoid "D" Control Circuit Low	P2769	10089	2769	Torque Converter Clutch Circuit Low
P2721	10017	2721	Pressure Control Solenoid "D" Control Circuit High	P2770	10096	2770	Torque Converter Clutch Circuit High
P2722	10018	2722	Pressure Control Solenoid "E"	P2A00	10752	2A00	O2 Sensor Circuit Range/Performance (Bank 1 Sensor 1)
P2723	10019	2723	Pressure Control Solenoid "E" Performance or Stuck Off	P2A01	10753	2A01	O2 Sensor Circuit Range/Performance (Bank 1 Sensor 2)
P2724	10020	2724	Pressure Control Solenoid "E" Stuck On	P2A02	10754	2A02	O2 Sensor Circuit Range/Performance (Bank 1 Sensor 3)
P2725	10021	2725	Pressure Control Solenoid "E" Electrical	P2A03	10755	2A03	O2 Sensor Circuit Range/Performance (Bank 2 Sensor 1)
P2726	10022	2726	Pressure Control Solenoid "E" Intermittent	P2A04	10756	2A04	O2 Sensor Circuit Range/Performance (Bank 2 Sensor 2)
P2727	10023	2727	Pressure Control Solenoid "E" Control Circuit / Open	P2A05	10757	2A05	O2 Sensor Circuit Range/Performance (Bank 2 Sensor 3)
P2728	10024	2728	Pressure Control Solenoid "E" Control Circuit Range/Performance	P3400	13312	3400	Cylinder Deactivation System
P2729	10025	2729	Pressure Control Solenoid "E" Control Circuit Low	P3401	13313	3401	Cylinder 1 Deactivation/Intake Valve Control Circuit/Open
P2730	10032	2730	Pressure Control Solenoid "E" Control Circuit High	P3402	13314	3402	Cylinder 1 Deactivation/Intake Valve Control Performance
P2731	10033	2731	Pressure Control Solenoid "F"	P3403	13315	3403	Cylinder 1 Deactivation/Intake Valve Control Circuit Low
P2732	10034	2732	Pressure Control Solenoid "F" Performance or Stuck Off	P3404	13316	3404	Cylinder 1 Deactivation/Intake Valve Control Circuit High
P2733	10035	2733	Pressure Control Solenoid "F" Stuck On	P3405	13317	3405	Cylinder 1 Exhaust Valve Control Circuit/Open
P2734	10036	2734	Pressure Control Solenoid "F" Electrical	P3406	13318	3406	Cylinder 1 Exhaust Valve Control Performance
P2735	10037	2735	Pressure Control Solenoid "F" Intermittent	P3407	13319	3407	Cylinder 1 Exhaust Valve Control Circuit Low
P2736	10038	2736	Pressure Control Solenoid "F" Control Circuit/Open	P3408	13320	3408	Cylinder 1 Exhaust Valve Control Circuit High
P2737	10039	2737	Pressure Control Solenoid "F" Control Circuit Range/Performance	P3409	13321	3409	Cylinder 2 Deactivation/Intake Valve Control Circuit/Open
P2738	10040	2738	Pressure Control Solenoid "F" Control Circuit Low	P3410	13328	3410	Cylinder 2 Deactivation/Intake Valve Control Performance
P2739	10041	2739	Pressure Control Solenoid "F" Control Circuit High	P3411	13329	3411	Cylinder 2 Deactivation/Intake Valve Control Circuit Low
P2740	10048	2740	Transmission Fluid Temperature Sensor "B" Circuit"	P3412	13330	3412	Cylinder 2 Deactivation/Intake Valve Control Circuit High
P2741	10049	2741	Transmission Fluid Temperature Sensor "B" Circuit Range Performance	P3413	13331	3413	Cylinder 2 Exhaust Valve Control Circuit/Open
P2742	10050	2742	Transmission Fluid Temperature Sensor "B" Circuit Low	P3414	13332	3414	Cylinder 2 Exhaust Valve Control Performance
P2743	10051	2743	Transmission Fluid Temperature Sensor "B" Circuit High	P3415	13333	3415	Cylinder 2 Exhaust Valve Control Circuit Low
P2744	10052	2744	Transmission Fluid Temperature Sensor "B" Circuit Intermittent	P3416	13334	3416	Cylinder 2 Exhaust Valve Control Circuit High
P2745	10053	2745	Intermediate Shaft Speed Sensor "B" Circuit	P3417	13335	3417	Cylinder 3 Deactivation/Intake Valve Control Circuit/Open
P2746	10054	2746	Intermediate Shaft Speed Sensor "B" Circuit Range/Performance	P3418	13336	3418	Cylinder 3 Deactivation/Intake Valve Control Performance
P2747	10055	2747	Intermediate Shaft Speed Sensor "B" Circuit No Signal	P3419	13337	3419	Cylinder 3 Deactivation/Intake Valve Control Circuit Low
P2748	10056	2748	Intermediate Shaft Speed Sensor "B" Circuit Intermittent	P3420	13344	3420	Cylinder 3 Deactivation/Intake Valve Control Circuit High
P2749	10057	2749	Intermediate Shaft Speed Sensor "C" Circuit	P3421	13345	3421	Cylinder 3 Exhaust Valve Control Circuit/Open
P2750	10064	2750	Intermediate Shaft Speed Sensor "C" Circuit Range/Performance	P3422	13346	3422	Cylinder 3 Exhaust Valve Control Performance
P2751	10065	2751	Intermediate Shaft Speed Sensor "C" Circuit No Signal	P3423	13347	3423	Cylinder 3 Exhaust Valve Control Circuit Low
P2752	10066	2752	Intermediate Shaft Speed Sensor "C" Circuit Intermittent	P3424	13348	3424	Cylinder 3 Exhaust Valve Control Circuit High
P2753	10067	2753	Transmission Fluid Cooler Control Circuit/Open	P3425	13349	3425	Cylinder 4 Deactivation/Intake Valve Control Circuit/Open
P2754	10068	2754	Transmission Fluid Cooler Control Circuit Low	P3426	13350	3426	Cylinder 4 Deactivation/Intake Valve Control Performance
P2755	10069	2755	Transmission Fluid Cooler Control Circuit High	P3427	13351	3427	Cylinder 4 Deactivation/Intake Valve Control Circuit Low
P2756	10070	2756	Torque Converter Clutch Pressure Control Solenoid	P3428	13352	3428	Cylinder 4 Deactivation/Intake Valve Control Circuit High
P2757	10071	2757	Torque Converter Clutch Pressure Control Solenoid Control Circuit Performance or Stuck Off	P3429	13353	3429	Cylinder 4 Exhaust Valve Control Circuit/Open
P2758	10072	2758	Torque Converter Clutch Pressure Control Solenoid Control Circuit Stuck On	P3430	13360	3430	Cylinder 4 Exhaust Valve Control Performance
P2759	10073	2759	Torque Converter Clutch Pressure Control Solenoid Control Circuit Electrical	P3431	13361	3431	Cylinder 4 Exhaust Valve Control Circuit Low
P2760	10080	2760	Torque Converter Clutch Pressure Control Solenoid Control Circuit Intermittent	P3432	13362	3432	Cylinder 4 Exhaust Valve Control Circuit High
P2761	10081	2761	Torque Converter Clutch Pressure Control Solenoid Control Circuit/Open	P3433	13363	3433	Cylinder 5 Deactivation/Intake Valve Control Circuit/Open
P2762	10082	2762	Torque Converter Clutch Pressure Control Solenoid Control Circuit Range/Performance	P3434	13364	3434	Cylinder 5 Deactivation/Intake Valve Control Performance
P2763	10083	2763	Torque Converter Clutch Pressure Control Solenoid Control Circuit High	P3435	13365	3435	Cylinder 5 Deactivation/Intake Valve Control Circuit Low
P2764	10084	2764	Torque Converter Clutch Pressure Control Solenoid Control Circuit Low	P3436	13366	3436	Cylinder 5 Deactivation/Intake Valve Control Circuit High
				P3437	13367	3437	Cylinder 5 Exhaust Valve Control Circuit/Open
				P3438	13368	3438	Cylinder 5 Exhaust Valve Control Performance

P3439	13369	3439	Cylinder 5 Exhaust Valve Control Circuit Low	P3490	13456	3490	Cylinder 12 Deactivation/Intake Valve Control Performance
P3440	13376	3440	Cylinder 5 Exhaust Valve Control Circuit High	P3491	13457	3491	Cylinder 12 Deactivation/Intake Valve Control Circuit Low
P3441	13377	3441	Cylinder 6 Deactivation/Intake Valve Control Circuit/Open	P3492	13458	3492	Cylinder 12 Deactivation/Intake Valve Control Circuit High
P3442	13378	3442	Cylinder 6 Deactivation/Intake Valve Control Performance	P3493	13459	3493	Cylinder 12 Exhaust Valve Control Circuit/Open
P3443	13379	3443	Cylinder 6 Deactivation/Intake Valve Control Circuit Low	P3494	13460	3494	Cylinder 12 Exhaust Valve Control Performance
P3444	13380	3444	Cylinder 6 Deactivation/Intake Valve Control Circuit High	P3495	13461	3495	Cylinder 12 Exhaust Valve Control Circuit Low
P3445	13381	3445	Cylinder 6 Exhaust Valve Control Circuit/Open	P3496	13462	3496	Cylinder 12 Exhaust Valve Control Circuit High
P3446	13382	3446	Cylinder 6 Exhaust Valve Control Performance				
P3447	13383	3447	Cylinder 6 Exhaust Valve Control Circuit Low				
P3448	13384	3448	Cylinder 6 Exhaust Valve Control Circuit High				
P3449	13385	3449	Cylinder 7 Deactivation/Intake Valve Control Circuit/Open				
P3450	13392	3450	Cylinder 7 Deactivation/Intake Valve Control Performance				
P3451	13393	3451	Cylinder 7 Deactivation/Intake Valve Control Circuit Low				
P3452	13394	3452	Cylinder 7 Deactivation/Intake Valve Control Circuit High				
P3453	13395	3453	Cylinder 7 Exhaust Valve Control Circuit/Open				
P3454	13396	3454	Cylinder 7 Exhaust Valve Control Performance				
P3455	13397	3455	Cylinder 7 Exhaust Valve Control Circuit Low				
P3456	13398	3456	Cylinder 7 Exhaust Valve Control Circuit High				
P3457	13399	3457	Cylinder 8 Deactivation/Intake Valve Control Circuit/Open				
P3458	13400	3458	Cylinder 8 Deactivation/Intake Valve Control Performance				
P3459	13401	3459	Cylinder 8 Deactivation/Intake Valve Control Circuit Low				
P3460	13408	3460	Cylinder 8 Deactivation/Intake Valve Control Circuit High				
P3461	13409	3461	Cylinder 8 Exhaust Valve Control Circuit/Open				
P3462	13410	3462	Cylinder 8 Exhaust Valve Control Performance				
P3463	13411	3463	Cylinder 8 Exhaust Valve Control Circuit Low				
P3464	13412	3464	Cylinder 8 Exhaust Valve Control Circuit High				
P3465	13413	3465	Cylinder 9 Deactivation/Intake Valve Control Circuit/Open				
P3466	13414	3466	Cylinder 9 Deactivation/Intake Valve Control Performance				
P3467	13415	3467	Cylinder 9 Deactivation/Intake Valve Control Circuit Low				
P3468	13416	3468	Cylinder 9 Deactivation/Intake Valve Control Circuit High				
P3469	13417	3469	Cylinder 9 Exhaust Valve Control Circuit/Open				
P3470	13424	3470	Cylinder 9 Exhaust Valve Control Performance				
P3471	13425	3471	Cylinder 9 Exhaust Valve Control Circuit Low				
P3472	13426	3472	Cylinder 9 Exhaust Valve Control Circuit High				
P3473	13427	3473	Cylinder 10 Deactivation/Intake Valve Control Circuit/Open				
P3474	13428	3474	Cylinder 10 Deactivation/Intake Valve Control Performance				
P3475	13429	3475	Cylinder 10 Deactivation/Intake Valve Control Circuit Low				
P3476	13430	3476	Cylinder 10 Deactivation/Intake Valve Control Circuit High				
P3477	13431	3477	Cylinder 10 Exhaust Valve Control Circuit/Open				
P3478	13432	3478	Cylinder 10 Exhaust Valve Control Performance				
P3479	13433	3479	Cylinder 10 Exhaust Valve Control Circuit Low				
P3480	13440	3480	Cylinder 10 Exhaust Valve Control Circuit High				
P3481	13441	3481	Cylinder 11 Deactivation/Intake Valve Control Circuit/Open				
P3482	13442	3482	Cylinder 11 Deactivation/Intake Valve Control Performance				
P3483	13443	3483	Cylinder 11 Deactivation/Intake Valve Control Circuit Low				
P3484	13444	3484	Cylinder 11 Deactivation/Intake Valve Control Circuit High				
P3485	13445	3485	Cylinder 11 Exhaust Valve Control Circuit/Open				
P3486	13446	3486	Cylinder 11 Exhaust Valve Control Performance				
P3487	13447	3487	Cylinder 11 Exhaust Valve Control Circuit Low				
P3488	13448	3488	Cylinder 11 Exhaust Valve Control Circuit High				
P3489	13449	3489	Cylinder 12 Deactivation/Intake Valve Control Circuit/Open				

**Códigos B:** En este caso no hay ningún código exigido por norma por lo que es el fabricante quien los realiza

Código OBD	Código Avería	Código HEX	Interpretación de la Avería
B1200	4608	1200	Climate Control Pushbutton Circuit Failure
B1201	4609	1201	Fuel Sender Circuit Failure
B1202	4610	1202	Fuel Sender Circuit Open
B1203	4611	1203	Fuel Sender Circuit Short To Battery
B1204	4612	1204	Fuel Sender Circuit Short To Ground
B1205	4613	1205	EIC Switch-1 Assembly Circuit Failure
B1206	4614	1206	EIC Switch-1 Assembly Circuit Open
B1207	4615	1207	EIC Switch-1 Assembly Circuit Short To Battery
B1208	4616	1208	EIC Switch-1 Assembly Circuit Short To Ground
B1209	4617	1209	EIC Switch-2 Assembly Circuit Failure
B1210	4624	1210	EIC Switch-2 Assembly Circuit Open
B1211	4625	1211	EIC Switch-2 Assembly Circuit Short To Battery
B1212	4626	1212	EIC Switch-2 Assembly Circuit Short To Ground
B1213	4627	1213	Anti-Theft Number of Programmed Keys Is Below Minimum
B1214	4628	1214	Running Board Lamp Circuit Failure
B1215	4629	1215	Running Board Lamp Circuit Short to Battery
B1216	4630	1216	Emergency & Road Side Assistance Switch Circuit Short to Ground
B1217	4631	1217	Horn Relay Coil Circuit Failure
B1218	4632	1218	Horn Relay Coil Circuit Short to Vbatt
B1219	4633	1219	Fuel Tank Pressure Sensor Circuit Failure
B1220	4640	1220	Fuel Tank Pressure Sensor Circuit Open
B1222	4642	1222	Fuel Temperature Sensor #1 Circuit Failure
B1223	4643	1223	Fuel Temperature Sensor #1 Circuit Open
B1224	4644	1224	Fuel Temperature Sensor #1 Circuit Short to Battery
B1225	4645	1225	Fuel Temperature Sensor #1 Circuit Short to Ground
B1226	4646	1226	Fuel Temperature Sensor #2 Circuit Failure
B1227	4647	1227	Fuel Temperature Sensor #2 Circuit Open
B1228	4648	1228	Fuel Temperature Sensor #2 Circuit Short to Battery
B1229	4649	1229	Fuel Temperature Sensor #2 Circuit Short to Ground
B1231	4657	1231	Longitudinal Acceleration Threshold Exceeded
B1232	4658	1232	See Manufacturer
B1233	4659	1233	Glass Break Sensor Failure
B1234	4660	1234	Mirror Switch Invalid Code
B1235	4661	1235	Window Feedback Failure
B1236	4662	1236	Window Feedback Loss of Signal
B1237	4663	1237	Window Feedback Out of Range
B1238	4664	1238	Over Temperature Fault
B1239	4665	1239	Air Flow Blend Door Driver Circuit Failure
B1240	4672	1240	Wiper Washer Rear Pump Relay Circuit Failure
B1241	4673	1241	Wiper Washer Rear Pump Relay Circuit Short to Battery
B1242	4674	1242	Air Flow Recirculation Door Driver Circuit Failure
B1243	4675	1243	Express Window Down Switch Circuit Short to Battery
B1244	4676	1244	Wiper Rear Motor Run Relay Circuit Failure
B1245	4677	1245	Wiper Rear Motor Run Relay Circuit Short to Battery
B1246	4678	1246	Dim Panel Potentiometer Switch Circuit Failure
B1247	4679	1247	Panel Dim Switch Circuit Open
B1248	4680	1248	Passenger's Seatback Autoglide Rearward Switch Circuit Short to Ground
B1249	4681	1249	Blend Door Failure
B1250	4688	1250	Air Temperature Internal Sensor Circuit Failure
B1251	4689	1251	Air Temperature Internal Sensor Circuit Open
B1252	4690	1252	Air Temperature Internal Sensor Circuit Short To Battery
B1253	4691	1253	Air Temperature Internal Sensor Circuit Short To Ground
B1254	4692	1254	Air Temperature External Sensor Circuit Failure
B1255	4693	1255	Air Temperature External Sensor Circuit Open
B1256	4694	1256	Air Temperature External Sensor Circuit Short To Battery
B1257	4695	1257	Air Temperature External Sensor Circuit Short To Ground
B1258	4696	1258	Solar Radiation Sensor Circuit Failure
B1259	4697	1259	Solar Radiation Sensor Circuit Open
B1260	4704	1260	Solar Radiation Sensor Circuit Short To Battery
B1261	4705	1261	Solar Radiation Sensor Circuit Short To Ground
B1262	4706	1262	Servo Motor Defrost Circuit Failure
B1263	4707	1263	Servo Motor Vent Circuit Failure
B1264	4708	1264	Servo Motor Foot Circuit Failure
B1265	4709	1265	Servo Motor Coolair Bypass Circuit Failure
B1266	4710	1266	Servo Motor Airintake Left Circuit Failure
B1267	4711	1267	Servo Motor Airintake Right Circuit Failure
B1268	4712	1268	Servo Motor Potentiometer Defrost Circuit Failure
B1269	4713	1269	Servo Motor Potentiometer Defrost Circuit Open
B1270	4720	1270	Servo Motor Potentiometer Defrost Circuit Short To Battery
B1271	4721	1271	Servo Motor Potentiometer Defrost Circuit Short To Ground
B1272	4722	1272	Servo Motor Potentiometer Vent Circuit Failure
B1273	4723	1273	Servo Motor Potentiometer Vent Circuit Open
B1274	4724	1274	Servo Motor Potentiometer Vent Circuit Short To Battery
B1275	4725	1275	Servo Motor Potentiometer Vent Circuit Short To Ground
B1276	4726	1276	Servo Motor Potentiometer Foot Circuit Failure
B1277	4727	1277	Servo Motor Potentiometer Foot Circuit Open
B1278	4728	1278	Servo Motor Potentiometer Foot Circuit Short To Battery
B1279	4729	1279	Servo Motor Potentiometer Foot Circuit Short To Ground
B1280	4736	1280	Servo Motor Potentiometer Coolair Circuit Failure
B1281	4737	1281	Servo Motor Potentiometer Coolair Circuit Open
B1282	4738	1282	Servo Motor Potentiometer Coolair Circuit Short To Battery
B1283	4739	1283	Servo Motor Potentiometer Coolair Circuit Short To Ground
B1284	4740	1284	Servo Motor Potentiometer Airintake Left Circuit Failure
B1285	4741	1285	Servo Motor Potentiometer Airintake Left Circuit Open
B1286	4742	1286	Servo Motor Potentiometer Airintake Left Circuit Short To Battery
B1287	4743	1287	Servo Motor Potentiometer Airintake Left Circuit Short To Ground
B1288	4744	1288	Servo Motor Potentiometer Airintake Right Circuit Failure
B1289	4745	1289	Servo Motor Potentiometer Airintake Right Circuit Open
B1290	4752	1290	Servo Motor Potentiometer Airintake Right Circuit Short To Battery
B1291	4753	1291	Servo Motor Potentiometer Airintake Right Circuit Short To Ground
B1292	4754	1292	Battery Power Relay Circuit Failure
B1293	4755	1293	Battery Power Relay Circuit Open
B1294	4756	1294	Battery Power Relay Circuit Short To Battery
B1295	4757	1295	Battery Power Relay Circuit Short To Ground
B1296	4758	1296	Power Supply Sensor Circuit Failure
B1297	4759	1297	Power Supply Sensor Circuit Open

B1298	4760	1298	Power Supply Sensor Circuit Short To Battery	B1349	4937	1349	Heated Backlite Relay Short To Battery
B1299	4761	1299	Power Supply Sensor Circuit Short To Ground	B1350	4944	1350	Heated Backlite Relay Short To Ground
B1300	4864	1300	Power Door Lock Circuit Failure	B1351	4945	1351	Ignition Key-In Circuit Short To Battery
B1301	4865	1301	Power Door Lock Circuit Open	B1352	4946	1352	Ignition Key-In Circuit Failure
B1302	4866	1302	Accessory Delay Relay Coil Circuit Failure	B1353	4947	1353	Ignition Key-In Circuit Open
B1303	4867	1303	Accessory Delay Relay Coil Circuit Open	B1354	4948	1354	Ignition Key-In Circuit Short To Ground
B1304	4868	1304	Accessory Delay Relay Coil Circuit Short To Battery	B1355	4949	1355	Ignition Run Circuit Failure
B1305	4869	1305	Accessory Delay Relay Coil Circuit Short To Ground	B1356	4950	1356	Ignition Run Circuit Open
B1306	4870	1306	Oil Level Switch Circuit Open	B1357	4951	1357	Ignition Run Circuit Short To Battery
B1307	4871	1307	Oil Level Switch Circuit Short To Battery	B1358	4952	1358	Ignition Run Circuit Short To Ground
B1308	4872	1308	Oil Level Switch Circuit Short To Ground	B1359	4953	1359	Ignition Run/Acc Circuit Failure
B1309	4873	1309	Power Door Lock Circuit Short To Ground	B1360	4960	1360	Ignition Run/Acc Circuit Open
B1310	4880	1310	Power Door Unlock Circuit Failure	B1361	4961	1361	Ignition Run/Acc Circuit Short To Battery
B1311	4881	1311	Power Door Unlock Circuit Open	B1362	4962	1362	Ignition Run/Acc Circuit Short To Ground
B1312	4882	1312	Lamp Headlamp Input Circuit Short To Battery	B1363	4963	1363	Ignition Start Circuit Failure
B1313	4883	1313	Battery Saver Relay Coil Circuit Failure	B1364	4964	1364	Ignition Start Circuit Open
B1314	4884	1314	Battery Saver Relay Coil Circuit Open	B1365	4965	1365	Ignition Start Circuit Short To Battery
B1315	4885	1315	Battery Saver Relay Coil Circuit Short To Battery	B1366	4966	1366	Ignition Start Circuit Short To Ground
B1316	4886	1316	Battery Saver Relay Coil Circuit Short To Ground	B1367	4967	1367	Ignition Tach Circuit Failure
B1317	4887	1317	Battery Voltage High	B1368	4968	1368	Ignition Tach Circuit Open
B1318	4888	1318	Battery Voltage Low	B1369	4969	1369	Ignition Tach Circuit Short To Battery
B1319	4889	1319	Driver Door Ajar Circuit Failure	B1370	4976	1370	Ignition Tach Circuit Short To Ground
B1320	4896	1320	Driver Door Ajar Circuit Open	B1371	4977	1371	Illuminated Entry Relay Circuit Failure
B1321	4897	1321	Driver Door Ajar Circuit Short To Battery	B1372	4978	1372	Illuminated Entry Relay Circuit Open
B1322	4898	1322	Driver Door Ajar Circuit Short To Ground	B1373	4979	1373	Illuminated Entry Relay Short To Battery
B1323	4899	1323	Door Ajar Lamp Circuit Failure	B1374	4980	1374	Illuminated Entry Relay Short To Ground
B1324	4900	1324	Door Ajar Lamp Circuit Open	B1375	4981	1375	Oil Change Lamp Circuit Open
B1325	4901	1325	Door Ajar Lamp Circuit Short To Battery	B1376	4982	1376	Oil Change Lamp Circuit Short To Battery
B1326	4902	1326	Door Ajar Lamp Circuit Short To Ground	B1377	4983	1377	Oil Change Lamp Circuit Failure
B1327	4903	1327	Passenger Door Ajar Circuit Failure	B1378	4984	1378	Oil Change Lamp Circuit Short To Ground
B1328	4904	1328	Passenger Door Ajar Circuit Open	B1379	4985	1379	Oil Change Reset Button Circuit Short To Ground
B1329	4905	1329	Passenger Door Ajar Circuit Short To Battery	B1380	4992	1380	Oil Change Reset Button Circuit Failure
B1330	4912	1330	Passenger Door Ajar Circuit Short To Ground	B1381	4993	1381	Oil Change Reset Button Circuit Open
B1331	4913	1331	Decklid Ajar Rear Door Circuit Failure	B1382	4994	1382	Oil Change Reset Button Circuit Short To Battery
B1332	4914	1332	Decklid Ajar Rear Door Circuit Open	B1383	4995	1383	Oil Level Lamp Circuit Short To Battery
B1333	4915	1333	Decklid Ajar Rear Door Circuit Short To Battery	B1384	4996	1384	Oil Level Lamp Circuit Failure
B1334	4916	1334	Decklid Ajar Rear Door Circuit Short To Ground	B1385	4997	1385	Oil Level Lamp Circuit Open
B1335	4917	1335	Door Ajar RR Circuit Failure	B1386	4998	1386	Oil Level Lamp Circuit Short To Ground
B1336	4918	1336	Door Ajar RR Circuit Open	B1387	4999	1387	Oil Temperature Sensor Circuit Open
B1337	4919	1337	Door Ajar RR Circuit Short To Battery	B1388	5000	1388	Oil Temperature Sensor Circuit Short To Battery
B1338	4920	1338	Door Ajar RR Circuit Short To Ground	B1389	5001	1389	Oil Temperature Sensor Circuit Failure
B1339	4921	1339	Chime Input Request Circuit Short To Battery	B1390	5008	1390	Oil Temperature Sensor Circuit Short To Ground
B1340	4928	1340	Chime Input Request Circuit Short To Ground	B1391	5009	1391	Oil Level Switch Circuit Failure
B1341	4929	1341	Power Door Unlock Circuit Short To Ground	B1392	5010	1392	Power Door Memory Lock Relay Circuit Failure
B1342	4930	1342	ECU Is Defective	B1393	5011	1393	Power Door Memory Lock Relay Circuit Open
B1343	4931	1343	Heated Backlite Input Circuit Failure	B1394	5012	1394	Power Door Memory Lock Relay Circuit Short To Battery
B1344	4932	1344	Heated Backlite Input Circuit Open	B1395	5013	1395	Power Door Memory Lock Relay Circuit Short To Ground
B1345	4933	1345	Heated Backlite Input Circuit Short To Ground	B1396	5014	1396	Power Door Lock Circuit Short To Battery
B1346	4934	1346	Heated Backlite Input Circuit Short To Battery	B1397	5015	1397	Power Door Unlock Circuit Short To Battery
B1347	4935	1347	Heated Backlite Relay Circuit Failure	B1398	5016	1398	Driver Power Window One Touch Window Relay Circuit Failure
B1348	4936	1348	Heated Backlite Relay Circuit Open	B1399	5017	1399	Driver Power Window One Touch Window Relay Circuit Open

B1400	5120	1400	Driver Power Window One Touch Window Relay Circuit Short To Battery	B1451	5201	1451	Wiper Wash/Delay Switch Circuit Open
B1401	5121	1401	Driver Power Window One Touch Window Relay Circuit Short To Ground	B1452	5202	1452	Wiper Wash/Delay Switch Circuit Short To Battery
B1402	5122	1402	Driver Power Window Down Switch Circuit Failure	B1453	5203	1453	Wiper Wash/Delay Switch Circuit Short To Ground
B1403	5123	1403	Driver Power Window Up Switch Circuit Failure	B1454	5204	1454	Wiper Washer Fluid Lamp Circuit Failure
B1404	5124	1404	Driver Power Window Down Circuit Open	B1455	5205	1455	Wiper Washer Fluid Lamp Circuit Open
B1405	5125	1405	Driver Power Window Down Circuit Short To Battery	B1456	5206	1456	Wiper Washer Fluid Lamp Circuit Short To Battery
B1406	5126	1406	Driver Power Window Down Circuit Short To Ground	B1457	5207	1457	Wiper Washer Fluid Lamp Circuit Short To Ground
B1407	5127	1407	Driver Power Window Up Circuit Open	B1458	5208	1458	Wiper Washer Pump Motor Relay Circuit Failure
B1408	5128	1408	Driver Power Window Up Circuit Short To Battery	B1459	5209	1459	Wiper Washer Pump Motor Relay Coil Circuit Open
B1409	5129	1409	Driver Power Window Up Circuit Short To Ground	B1460	5216	1460	Wiper Washer Pump Motor Relay Coil Circuit Short To Battery
B1410	5136	1410	Driver Power Window Motor Circuit Failure	B1461	5217	1461	Wiper Washer Pump Motor Relay Coil Circuit Short To Ground
B1411	5137	1411	Driver Power Window Motor Circuit Open	B1462	5218	1462	Seat Belt Switch Circuit Failure
B1412	5138	1412	Driver Power Window Motor Circuit Short To Battery	B1463	5219	1463	Seat Belt Switch Circuit Open
B1413	5139	1413	Driver Power Window Motor Circuit Short To Ground	B1464	5220	1464	Seat Belt Switch Circuit Short To Battery
B1414	5140	1414	Power Window LR Motor Circuit Failure	B1465	5221	1465	Wiper Brake/Run Relay Circuit Open
B1415	5141	1415	Power Window LR Motor Circuit Open	B1466	5222	1466	Wiper Hi/Low Speed Not Switching
B1416	5142	1416	Power Window LR Motor Circuit Short To Battery	B1467	5223	1467	Wiper Hi/Low Speed Circuit Motor Short To Battery
B1417	5143	1417	Power Window LR Motor Circuit Short To Ground	B1468	5224	1468	Chime Input Request Circuit Failure
B1418	5144	1418	Passenger Power Window Motor Circuit Failure	B1469	5225	1469	Chime Input Request Circuit Open
B1419	5145	1419	Passenger Power Window Motor Circuit Open	B1470	5232	1470	Lamp Headlamp Input Circuit Failure
B1420	5152	1420	Passenger Power Window Motor Circuit Short To Battery	B1471	5233	1471	Lamp Headlamp Input Circuit Open
B1421	5153	1421	Passenger Power Window Motor Circuit Short To Ground	B1472	5234	1472	Lamp Headlamp Input Circuit Short To Ground
B1422	5154	1422	Power Window RR Motor Circuit Failure	B1473	5235	1473	Wiper Low Speed Circuit Motor Failure
B1423	5155	1423	Power Window RR Motor Circuit Open	B1474	5236	1474	Battery Saver Power Relay Circuit Short To Battery
B1424	5156	1424	Power Window RR Motor Circuit Short To Battery	B1475	5237	1475	Accessory Delay Relay Contact Short To Battery
B1425	5157	1425	Power Window RR Motor Circuit Short To Ground	B1476	5238	1476	Wiper High Speed Circuit Motor Failure
B1426	5158	1426	Lamp Seat Belt Circuit Short To Battery	B1477	5239	1477	Wiper Hi/Low Circuit Motor Short To Ground
B1427	5159	1427	Lamp Seat Belt Circuit Open	B1478	5240	1478	Power Window One Touch Up/Down Activated Simultaneously
B1428	5160	1428	Lamp Seat Belt Circuit Failure	B1479	5241	1479	Wiper Washer Fluid Level Sensor Circuit Failure
B1429	5161	1429	Lamp Seat Belt Circuit Short To Ground	B1480	5248	1480	Wiper Washer Fluid Level Sensor Circuit Open
B1430	5168	1430	Seat Belt Switch Circuit Short To Ground	B1481	5249	1481	Wiper Washer Fluid Level Sensor Circuit Short To Battery
B1431	5169	1431	Wiper Brake/Run Relay Circuit Failure	B1482	5250	1482	Wiper Washer Fluid Level Sensor Circuit Short To Ground
B1432	5170	1432	Wiper Brake/Run Relay Circuit Short To Battery	B1483	5251	1483	Brake Pedal Input Circuit Failure
B1433	5171	1433	Wiper Brake/Run Relay Circuit Short To Ground	B1484	5252	1484	Brake Pedal Input Open Circuit
B1434	5172	1434	Wiper Hi/Low Speed Relay Coil Circuit Failure	B1485	5253	1485	Brake Pedal Input Circuit Battery Short
B1435	5173	1435	Wiper Hi/Low Speed Relay Coil Circuit Open	B1486	5254	1486	Brake Pedal Input Circuit Ground Short
B1436	5174	1436	Wiper Hi/Low Speed Relay Coil Circuit Short To Battery	B1487	5255	1487	Door Handle Right Front Circuit Failure
B1437	5175	1437	Wiper Hi/Low Speed Relay Coil Circuit Short To Ground	B1488	5256	1488	Door Handle Right Front Circuit Open
B1438	5176	1438	Wiper Mode Select Switch Circuit Failure	B1489	5257	1489	Door Handle Right Front Short To Battery
B1439	5177	1439	Wiper Mode Select Switch Circuit Open	B1490	5264	1490	Door Handle Right Front Short To Ground
B1440	5184	1440	Wiper Mode Select Switch Circuit Short To Battery	B1491	5265	1491	Ignition Cylinder Sensor Circuit Failure
B1441	5185	1441	Wiper Mode Select Switch Circuit Short To Ground	B1492	5266	1492	Ignition Cylinder Sensor Open Circuit
B1442	5186	1442	Door Handle Switch Circuit Failure	B1493	5267	1493	Ignition Cylinder Sensor Battery Short
B1443	5187	1443	Door Handle Switch Circuit Open	B1494	5268	1494	Ignition Cylinder Sensor Ground Short
B1444	5188	1444	Door Handle Switch Circuit Short To Battery	B1495	5269	1495	Decklid Punch-Out Sensor Circuit Failure
B1445	5189	1445	Door Handle Switch Circuit Short To Ground	B1496	5270	1496	Decklid Punch-Out Sensor Open Circuit
B1446	5190	1446	Wiper Park Sense Circuit Failure	B1497	5271	1497	Decklid Punch-Out Sensor Battery Short
B1447	5191	1447	Wiper Park Sense Circuit Open	B1498	5272	1498	Decklid Punch-Out Sensor Ground Short
B1448	5192	1448	Wiper Park Sense Circuit Short To Battery	B1499	5273	1499	Lamp Turn Signal Left Circuit Failure
B1449	5193	1449	Wiper Park Sense Circuit Short To Ground	B1500	5376	1500	Lamp Turn Signal Left Circuit Open
B1450	5200	1450	Wiper Wash/Delay Switch Circuit Failure	B1501	5377	1501	Lamp Turn Signal Left Circuit Short To Battery



B1502	5378	1502	Lamp Turn Signal Left Circuit Short To Ground	B1553	5459	1553	Decklid Release Circuit Short To Battery
B1503	5379	1503	Lamp Turn Signal Right Circuit Failure	B1554	5460	1554	Decklid Release Circuit Short To Ground
B1504	5380	1504	Lamp Turn Signal Right Circuit Open	B1555	5461	1555	Ignition Run/Start Circuit Failure
B1505	5381	1505	Lamp Turn Signal Right Circuit Short To Battery	B1556	5462	1556	Ignition Run/Start Circuit Open
B1506	5382	1506	Lamp Turn Signal Right Circuit Short To Ground	B1557	5463	1557	Ignition Run/Start Circuit Short To Battery
B1507	5383	1507	Flash To Pass Switch Circuit Failure	B1558	5464	1558	Ignition Run/Start Circuit Short To Ground
B1508	5384	1508	Flash To Pass Switch Circuit Open	B1559	5465	1559	Door Lock Cylinder Circuit Failure
B1509	5385	1509	Flash To Pass Switch Circuit Short To Battery	B1560	5472	1560	Door Lock Cylinder Circuit Open
B1510	5392	1510	Flash To Pass Switch Circuit Short To Ground	B1561	5473	1561	Door Lock Cylinder Circuit Short To Battery
B1511	5393	1511	Driver Door Handle Circuit Failure	B1562	5474	1562	Door Lock Cylinder Circuit Short To Ground
B1512	5394	1512	Driver Door Handle Circuit Open	B1563	5475	1563	Door Ajar Circuit Failure
B1513	5395	1513	Driver Door Handle Circuit Short To Battery	B1564	5476	1564	Door Ajar Circuit Open
B1514	5396	1514	Driver Door Handle Circuit Short To Ground	B1565	5477	1565	Door Ajar Circuit Short To Battery
B1515	5397	1515	Seat Driver Occupied Switch Circuit Failure	B1566	5478	1566	Door Ajar Circuit Short To Ground
B1516	5398	1516	Seat Driver Occupied Switch Circuit Open	B1567	5479	1567	Lamp Headlamp High-Beam Circuit Failure
B1517	5399	1517	Seat Driver Occupied Switch Circuit Short To Battery	B1568	5480	1568	Lamp Headlamp High-Beam Circuit Open
B1518	5400	1518	Seat Driver Occupied Switch Circuit Short To Ground	B1569	5481	1569	Lamp Headlamp High-Beam Circuit Short To Battery
B1519	5401	1519	Hood Switch Circuit Failure	B1570	5488	1570	Lamp Headlamp High-Beam Circuit Short To Ground
B1520	5408	1520	Hood Switch Circuit Open	B1571	5489	1571	Door Ajar LR Circuit Failure
B1521	5409	1521	Hood Switch Circuit Short To Battery	B1572	5490	1572	Door Ajar LR Circuit Open
B1522	5410	1522	Hood Switch Circuit Short To Ground	B1573	5491	1573	Door Ajar LR Circuit Short To Battery
B1523	5411	1523	Keyless Entry Circuit Failure	B1574	5492	1574	Door Ajar LR Circuit Short To Ground
B1524	5412	1524	Keyless Entry Circuit Open	B1575	5493	1575	Lamp Park Input Circuit Failure
B1525	5413	1525	Keyless Entry Circuit Short To Battery	B1576	5494	1576	Lamp Park Input Circuit Open
B1526	5414	1526	Keyless Entry Circuit Short To Ground	B1577	5495	1577	Lamp Park Input Circuit Short To Battery
B1527	5415	1527	Memory Set Switch Circuit Failure	B1578	5496	1578	Lamp Park Input Circuit Short To Ground
B1528	5416	1528	Memory Set Switch Circuit Open	B1579	5497	1579	Dim Panel Increase Input Circuit Failure
B1529	5417	1529	Memory Set Switch Circuit Short To Battery	B1580	5504	1580	Dim Panel Increase Input Circuit Open
B1530	5424	1530	Memory Set Switch Circuit Short To Ground	B1581	5505	1581	Dim Panel Increase Input Circuit Short To Battery
B1531	5425	1531	Memory 1 Switch Circuit Failure	B1582	5506	1582	Dim Panel Increase Input Circuit Short To Ground
B1532	5426	1532	Memory 1 Switch Circuit Open	B1583	5507	1583	Dim Panel Decrease Input Circuit Failure
B1533	5427	1533	Memory 1 Switch Circuit Short To Battery	B1584	5508	1584	Dim Panel Decrease Input Circuit Open
B1534	5428	1534	Memory 1 Switch Circuit Short To Ground	B1585	5509	1585	Dim Panel Decrease Input Circuit Short To Battery
B1535	5429	1535	Memory 2 Switch Circuit Failure	B1586	5510	1586	Dim Panel Decrease Input Circuit Short To Ground
B1536	5430	1536	Memory 2 Switch Circuit Open	B1587	5511	1587	Autolamp Delay Increase Circuit Failure
B1537	5431	1537	Memory 2 Switch Circuit Short To Battery	B1588	5512	1588	Autolamp Delay Increase Circuit Open
B1538	5432	1538	Memory 2 Switch Circuit Short To Ground	B1589	5513	1589	Autolamp Delay Increase Circuit Short To Battery
B1539	5433	1539	Mirror Driver Switch Assembly Circuit Failure	B1590	5520	1590	Autolamp Delay Increase Circuit Short To Ground
B1540	5440	1540	Mirror Driver Switch Assembly Circuit Open	B1591	5521	1591	Autolamp Delay Decrease Circuit Failure
B1541	5441	1541	Mirror Driver Switch Assembly Circuit Short To Battery	B1592	5522	1592	Autolamp Delay Decrease Circuit Open
B1542	5442	1542	Mirror Driver Switch Assembly Circuit Short To Ground	B1593	5523	1593	Autolamp Delay Decrease Circuit Short To Battery
B1543	5443	1543	Seat Direction Switch Assembly Circuit Failure	B1594	5524	1594	Autolamp Delay Decrease Circuit Short To Ground
B1544	5444	1544	Seat Direction Switch Assembly Circuit Open	B1595	5525	1595	Ignition Switch Illegal Input Code
B1545	5445	1545	Seat Direction Switch Assembly Circuit Short To Battery	B1596	5526	1596	Service Continuous Codes
B1546	5446	1546	Seat Direction Switch Assembly Circuit Short To Ground	B1597	5527	1597	Driver's Seat Seatback Autoglide Forward Switch Circuit Short to Ground
B1547	5447	1547	Power Window Master Circuit Failure	B1598	5528	1598	Driver's Seat Seatback Autoglide Rearward Switch Circuit Short to Ground
B1548	5448	1548	Power Window Master Circuit Open	B1599	5529	1599	Passenger's Seatback Autoglide Forward Switch Circuit Short to Ground
B1549	5449	1549	Power Window Master Circuit Short To Battery	B1600	5632	1600	PATS Ignition Key Transponder Signal Is Not Received
B1550	5456	1550	Power Window Master Circuit Short To Ground	B1601	5633	1601	PATS Received Incorrect Key-Code From Ignition Key Transponder
B1551	5457	1551	Decklid Release Circuit Failure	B1602	5634	1602	PATS Received Invalid Format Of Key-Code From Ignition Key Transponder
B1552	5458	1552	Decklid Release Circuit Open	B1603	5635	1603	Lamp Anti-Theft Indicator Circuit Failure

B1604	5636	1604	Lamp Anti-Theft Indicator Circuit Open	B1655	5717	1655	Seat Driver Rear Up Circuit Failure
B1605	5637	1605	Lamp Anti-Theft Indicator Circuit Short To Battery	B1656	5718	1656	Seat Driver Rear Up Circuit Open
B1606	5638	1606	Lamp Anti-Theft Indicator Circuit Short To Ground	B1657	5719	1657	Seat Driver Rear Up Circuit Short To Battery
B1607	5639	1607	Illuminated Entry Input Circuit Failure	B1658	5720	1658	Seat Driver Rear Up Circuit Short To Ground
B1608	5640	1608	Illuminated Entry Input Open Circuit	B1659	5721	1659	Seat Driver Front Up Circuit Failure
B1609	5641	1609	Illuminated Entry Input Short Circuit To Battery	B1660	5728	1660	Seat Driver Front Up Circuit Open
B1610	5648	1610	Illuminated Entry Input Short Circuit To Ground	B1661	5729	1661	Seat Driver Front Up Circuit Short To Battery
B1611	5649	1611	Wiper Rear Mode Select Switch Circuit Failure	B1662	5730	1662	Seat Driver Front Up Circuit Short To Ground
B1612	5650	1612	Wiper Rear Mode Select Switch Circuit Open	B1663	5731	1663	Seat Driver Front Up/Down Motor Stalled
B1613	5651	1613	Wiper Rear Mode Select Switch Circuit Short To Battery	B1664	5732	1664	Seat Driver Rear Up/Down Motor Stalled
B1614	5652	1614	Wiper Rear Mode Select Switch Circuit Short To Ground	B1665	5733	1665	Seat Driver Forward/Backward Motor Stalled
B1615	5653	1615	Wiper Rear Disable Switch Circuit Failure	B1666	5734	1666	Seat Driver Recline Motor Stalled
B1616	5654	1616	Wiper Rear Disable Switch Circuit Open	B1667	5735	1667	Mirror Driver Up/Down Motor Stalled
B1617	5655	1617	Wiper Rear Disable Switch Circuit Short To Battery	B1668	5736	1668	Mirror Driver Right/Left Motor Stalled
B1618	5656	1618	Wiper Rear Disable Switch Circuit Short To Ground	B1669	5737	1669	Mirror Passenger Up/Down Motor Stalled
B1619	5657	1619	Wiper Rear Low Limit Input Circuit Failure	B1670	5744	1670	Mirror Passenger Right/Left Motor Stalled
B1620	5664	1620	Wiper Rear Low Limit Input Circuit Open	B1671	5745	1671	Battery Module Voltage Out Of Range
B1621	5665	1621	Wiper Rear Low Limit Input Circuit Short To Battery	B1672	5746	1672	Seat Driver Occupied Input Circuit Failure
B1622	5666	1622	Wiper Rear Low Limit Input Circuit Short To Ground	B1673	5747	1673	Seat Driver Occupied Input Circuit Open
B1623	5667	1623	Lamp Keypad Output Circuit Failure	B1674	5748	1674	Seat Driver Occupied Input Circuit Short To Battery
B1624	5668	1624	Lamp Keypad Output Open Circuit	B1675	5749	1675	Seat Driver Occupied Input Circuit Short To Ground
B1625	5669	1625	Lamp Keypad Output Short Circuit To Battery	B1676	5750	1676	Battery Pack Voltage Out Of Range
B1626	5670	1626	Lamp Keypad Output Short Circuit To Ground	B1677	5751	1677	Alarm Panic Input Circuit Failure
B1627	5671	1627	PRNDL Reverse Input Circuit Failure	B1678	5752	1678	Alarm Panic Input Circuit Open
B1628	5672	1628	PRNDL Reverse Input Open Circuit	B1679	5753	1679	Alarm Panic Input Circuit Short To Battery
B1629	5673	1629	PRNDL Reverse Input Short To Battery	B1680	5760	1680	Alarm Panic Input Circuit Short To Ground
B1630	5680	1630	PRNDL Reverse Input Short Circuit To Ground	B1681	5761	1681	PATS Transceiver Module Signal Is Not Received
B1631	5681	1631	Mirror Driver Left Circuit Failure	B1682	5762	1682	PATS Is Disabled (Check Link Between PATS And Transponder)
B1632	5682	1632	Mirror Driver Left Circuit Open	B1683	5763	1683	Mirror Driver/Passenger Switch Circuit Failure
B1633	5683	1633	Mirror Driver Left Circuit Short To Battery	B1684	5764	1684	Mirror Driver/Passenger Switch Circuit Open
B1634	5684	1634	Mirror Driver Left Circuit Short To Ground	B1685	5765	1685	Lamp Dome Input Circuit Failure
B1635	5685	1635	Mirror Driver Right Circuit Failure	B1686	5766	1686	Lamp Dome Input Circuit Open
B1636	5686	1636	Mirror Driver Right Circuit Open	B1687	5767	1687	Lamp Dome Input Circuit Short To Battery
B1637	5687	1637	Mirror Driver Right Circuit Short To Battery	B1688	5768	1688	Lamp Dome Input Circuit Short To Ground
B1638	5688	1638	Mirror Driver Right Short To Ground	B1689	5769	1689	Autolamp Delay Circuit Failure
B1639	5689	1639	Mirror Passenger Left Circuit Failure	B1690	5776	1690	Autolamp Delay Circuit Open
B1640	5696	1640	Mirror Passenger Left Circuit Open	B1691	5777	1691	Autolamp Delay Circuit Short To Battery
B1641	5697	1641	Mirror Passenger Left Circuit Short To Battery	B1692	5778	1692	Autolamp Delay Circuit Short To Ground
B1642	5698	1642	Mirror Passenger Left Circuit Short To Ground	B1693	5779	1693	Autolamp On Circuit Failure
B1643	5699	1643	Mirror Passenger Right Circuit Failure	B1694	5780	1694	Autolamp On Circuit Open
B1644	5700	1644	Mirror Passenger Right Circuit Open	B1695	5781	1695	Autolamp On Circuit Short To Battery
B1645	5701	1645	Mirror Passenger Right Circuit Short To Battery	B1696	5782	1696	Autolamp On Circuit Short To Ground
B1646	5702	1646	Mirror Passenger Right Circuit Short To Ground	B1697	5783	1697	Mirror Driver/Passenger Switch Circuit Short To Battery
B1647	5703	1647	Seat Driver Recline Forward Circuit Failure	B1698	5784	1698	Mirror Driver/Passenger Switch Circuit Short To Ground
B1648	5704	1648	Seat Driver Recline Forward Circuit Open	B1699	5785	1699	Passenger's Seat Occupied Switch Circuit Short to Ground
B1649	5705	1649	Seat Driver Recline Forward Circuit Short To Battery	B1700	5888	1700	Passenger's Seatbelt Tension Reducer Circuit Short to Ground
B1650	5712	1650	Seat Driver Recline Forward Circuit Short To Ground	B1701	5889	1701	Seat Driver Recline Forward Switch Circuit Failure
B1651	5713	1651	Seat Driver Recline Backward Circuit Failure	B1702	5890	1702	Seat Driver Recline Forward Switch Circuit Open
B1652	5714	1652	Seat Driver Recline Backward Circuit Open	B1703	5891	1703	Seat Driver Recline Forward Switch Circuit Short To Battery
B1653	5715	1653	Seat Driver Recline Backward Circuit Short To Battery	B1704	5892	1704	Seat Driver Recline Forward Switch Circuit Short To Ground
B1654	5716	1654	Seat Driver Recline Backward Circuit Short To Ground	B1705	5893	1705	Seat Driver Recline Rearward Switch Circuit Failure

B1706	5894	1706	Seat Driver Recline Rearward Switch Circuit Open	B1757	5975	1757	Seat Driver Rear Down Circuit Failure
B1707	5895	1707	Seat Driver Recline Rearward Switch Circuit Short To Battery	B1758	5976	1758	Seat Driver Rear Down Circuit Open
B1708	5896	1708	Seat Driver Recline Rearward Switch Circuit Short To Ground	B1759	5977	1759	Seat Driver Rear Down Circuit Short To Battery
B1709	5897	1709	Seat Driver Front Up Switch Circuit Failure	B1760	5984	1760	Seat Driver Rear Down Circuit Short To Ground
B1710	5904	1710	Seat Driver Front Up Switch Circuit Open	B1761	5985	1761	Seat Driver Front Down Circuit Failure
B1711	5905	1711	Seat Driver Front Up Switch Circuit Short To Battery	B1762	5986	1762	Seat Driver Front Down Circuit Open
B1712	5906	1712	Seat Driver Front Up Switch Circuit Short To Ground	B1763	5987	1763	Seat Driver Front Down Circuit Short To Battery
B1713	5907	1713	Seat Driver Front Down Switch Circuit Failure	B1764	5988	1764	Seat Driver Front Down Circuit Short To Ground
B1714	5908	1714	Seat Driver Front Down Switch Circuit Open	B1765	5989	1765	Seat Driver Forward Circuit Failure
B1715	5909	1715	Seat Driver Front Down Switch Circuit Short To Battery	B1766	5990	1766	Seat Driver Forward Circuit Open
B1716	5910	1716	Seat Driver Front Down Switch Circuit Short To Ground	B1767	5991	1767	Seat Driver Forward Circuit Short To Battery
B1717	5911	1717	Seat Driver Forward Switch Circuit Failure	B1768	5992	1768	Seat Driver Forward Circuit Short To Ground
B1718	5912	1718	Seat Driver Forward Switch Circuit Open	B1769	5993	1769	Seat Driver Backward Circuit Failure
B1719	5913	1719	Seat Driver Forward Switch Circuit Short To Battery	B1770	6000	1770	Seat Driver Backward Circuit Open
B1720	5920	1720	Seat Driver Forward Switch Circuit Short To Ground	B1771	6001	1771	Seat Driver Backward Circuit Short To Battery
B1721	5921	1721	Seat Driver Rearward Switch Circuit Failure	B1772	6002	1772	Seat Driver Backward Circuit Short To Ground
B1722	5922	1722	Seat Driver Rearward Switch Circuit Open	B1773	6003	1773	Mirror Driver Up Circuit Failure
B1723	5923	1723	Seat Driver Rearward Switch Circuit Short To Battery	B1774	6004	1774	Mirror Driver Up Circuit Open
B1724	5924	1724	Seat Driver Rearward Switch Circuit Short To Ground	B1775	6005	1775	Mirror Driver Up Circuit Short To Battery
B1725	5925	1725	Seat Driver Rear Up Switch Circuit Failure	B1776	6006	1776	Mirror Driver Up Circuit Short To Ground
B1726	5926	1726	Seat Driver Rear Up Switch Circuit Open	B1777	6007	1777	Driver's Seatbelt Tension Reducer Circuit Short to Ground
B1727	5927	1727	Seat Driver Rear Up Switch Circuit Short To Battery	B1778	6008	1778	Mirror Driver Down Circuit Failure
B1728	5928	1728	Seat Driver Rear Up Switch Circuit Short To Ground	B1779	6009	1779	Mirror Driver Down Circuit Open
B1729	5929	1729	Seat Driver Rear Down Switch Circuit Failure	B1780	6016	1780	Mirror Driver Down Circuit Short To Battery
B1730	5936	1730	Seat Driver Rear Down Switch Circuit Open	B1781	6017	1781	Mirror Driver Down Short To Ground
B1731	5937	1731	Seat Driver Rear Down Switch Circuit Short To Battery	B1782	6018	1782	Mirror Passenger Up Circuit Failure
B1732	5938	1732	Seat Driver Rear Down Switch Circuit Short To Ground	B1783	6019	1783	Mirror Passenger Up Circuit Open
B1733	5939	1733	Mirror Driver Vertical Switch Circuit Failure	B1784	6020	1784	Mirror Passenger Up Circuit Short To Battery
B1734	5940	1734	Mirror Driver Vertical Switch Circuit Open	B1785	6021	1785	Mirror Passenger Up Circuit Short To Ground
B1735	5941	1735	Mirror Driver Vertical Switch Circuit Short To Battery	B1786	6022	1786	Mirror Passenger Down Circuit Failure
B1736	5942	1736	Mirror Driver Vertical Switch Circuit Short To Ground	B1787	6023	1787	Mirror Passenger Down Circuit Open
B1737	5943	1737	Mirror Driver Horizontal Switch Circuit Failure	B1788	6024	1788	Mirror Passenger Down Circuit Short To Battery
B1738	5944	1738	Mirror Driver Horizontal Switch Circuit Open	B1789	6025	1789	Mirror Passenger Down Circuit Short To Ground
B1739	5945	1739	Mirror Driver Horizontal Switch Circuit Short To Battery	B1790	6032	1790	Autolamp Sensor Input Circuit Failure
B1740	5952	1740	Mirror Driver Horizontal Switch Circuit Short To Ground	B1791	6033	1791	Autolamp Sensor Input Circuit Open
B1741	5953	1741	Mirror Passenger Vertical Switch Circuit Failure	B1792	6034	1792	Autolamp Sensor Input Circuit Short To Battery
B1742	5954	1742	Mirror Passenger Vertical Switch Circuit Open	B1793	6035	1793	Autolamp Sensor Input Circuit Short To Ground
B1743	5955	1743	Mirror Passenger Vertical Switch Circuit Short To Battery	B1794	6036	1794	Lamp Headlamp Low-Beam Circuit Failure
B1744	5956	1744	Mirror Passenger Vertical Switch Circuit Short To Ground	B1795	6037	1795	Lamp Headlamp Low-Beam Circuit Open
B1745	5957	1745	Mirror Passenger Horizontal Switch Circuit Failure	B1796	6038	1796	Lamp Headlamp Low-Beam Circuit Short To Battery
B1746	5958	1746	Mirror Passenger Horizontal Switch Circuit Open	B1797	6039	1797	Lamp Headlamp Low-Beam Circuit Short To Ground
B1747	5959	1747	Mirror Passenger Horizontal Switch Circuit Short To Battery	B1798	6040	1798	Lamp Turn Signal Front Output Circuit Failure
B1748	5960	1748	Mirror Passenger Horizontal Switch Circuit Short To Ground	B1799	6041	1799	Lamp Turn Signal Front Output Circuit Open
B1749	5961	1749	Park/Neutral Switch Circuit Failure	B1800	6144	1800	Lamp Turn Signal Front Output Circuit Short To Battery
B1750	5968	1750	Park/Neutral Switch Circuit Open	B1801	6145	1801	Lamp Turn Signal Front Output Circuit Short To Ground
B1751	5969	1751	Park/Neutral Switch Circuit Short To Battery	B1802	6146	1802	Lamp Turn Signal Rear Output Circuit Failure
B1752	5970	1752	Park/Neutral Switch Circuit Short To Ground	B1803	6147	1803	Lamp Turn Signal Rear Output Circuit Open
B1753	5971	1753	Hazard Flash Output Circuit Failure	B1804	6148	1804	Lamp Turn Signal Rear Output Circuit Short To Battery
B1754	5972	1754	Hazard Flash Output Circuit Open	B1805	6149	1805	Lamp Turn Signal Rear Output Circuit Short To Ground
B1755	5973	1755	Hazard Flash Output Circuit Short Battery	B1806	6150	1806	Lamp Tail Output Circuit Failure
B1756	5974	1756	Hazard Flash Output Circuit Short To Ground	B1807	6151	1807	Lamp Tail Output Circuit Open

B1808	6152	1808	Lamp Tail Output Circuit Short To Battery
B1809	6153	1809	Lamp Tail Output Circuit Short To Ground
B1810	6160	1810	Lamp Backup Switch Input Circuit Failure
B1811	6161	1811	Lamp Backup Switch Input Circuit Open
B1812	6162	1812	Lamp Backup Switch Input Circuit Short To Battery
B1813	6163	1813	Lamp Backup Switch Input Circuit Short To Ground
B1814	6164	1814	Wiper Rear Motor Down Relay Coil Circuit Failure
B1815	6165	1815	Wiper Rear Motor Down Relay Coil Circuit Open
B1816	6166	1816	Wiper Rear Motor Down Relay Coil Circuit Short To Battery
B1817	6167	1817	Wiper Rear Motor Down Relay Coil Circuit Short To Ground
B1818	6168	1818	Wiper Rear Motor Up Relay Coil Circuit Failure
B1819	6169	1819	Wiper Rear Motor Up Relay Coil Circuit Open
B1820	6176	1820	Wiper Rear Motor Up Relay Coil Circuit Short To Battery
B1821	6177	1821	Wiper Rear Motor Up Relay Coil Circuit Short To Ground
B1822	6178	1822	Wiper Rear Park Sense Input Circuit Failure
B1823	6179	1823	Wiper Rear Park Sense Input Circuit Open
B1824	6180	1824	Wiper Rear Park Sense Input Circuit Short To Battery
B1825	6181	1825	Wiper Rear Park Sense Input Circuit Short To Ground
B1826	6182	1826	Wiper Rear High Limit Input Circuit Failure
B1827	6183	1827	Wiper Rear High Limit Input Circuit Open
B1828	6184	1828	Wiper Rear High Limit Input Circuit Short To Battery
B1829	6185	1829	Wiper Rear High Limit Input Circuit Short To Ground
B1830	6192	1830	Door Unlock Disarm Switch Circuit Failure
B1831	6193	1831	Door Unlock Disarm Switch Circuit Open
B1832	6194	1832	Door Unlock Disarm Switch Circuit Short To Battery
B1833	6195	1833	Door Unlock Disarm Switch Circuit Short To Ground
B1834	6196	1834	Door Unlock Disarm Output Circuit Failure
B1835	6197	1835	Door Unlock Disarm Output Circuit Open
B1836	6198	1836	Door Unlock Disarm Output Circuit Short To Battery
B1837	6199	1837	Door Unlock Disarm Output Circuit Short To Ground
B1838	6200	1838	Battery Saver Power Relay Circuit Failure
B1839	6201	1839	Wiper Rear Motor Circuit Failure
B1840	6208	1840	Wiper Front Power Circuit Failure
B1841	6209	1841	Wiper Front Power Circuit Open
B1842	6210	1842	Wiper Front Power Circuit Short To Battery
B1843	6211	1843	Wiper Front Power Circuit Short To Ground
B1844	6212	1844	Phone Handset Circuit Failure
B1845	6213	1845	Ignition Tamper Circuit Failure
B1846	6214	1846	Ignition Tamper Circuit Open
B1847	6215	1847	Ignition Tamper Circuit Short To Battery
B1848	6216	1848	Ignition Tamper Circuit Short To Ground
B1849	6217	1849	Climate Control Temperature Differential Circuit Failure
B1850	6224	1850	Climate Control Temperature Differential Circuit Open
B1851	6225	1851	Climate Control Temperature Differential Circuit Short To Battery
B1852	6226	1852	Climate Control Temperature Differential Circuit Short To Ground
B1853	6227	1853	Climate Control Air Temperature Internal Sensor Motor Circuit Failure
B1854	6228	1854	Climate Control Air Temperature Internal Sensor Motor Circuit Open
B1855	6229	1855	Climate Control Air Temperature Internal Sensor Motor Circuit Short To Battery
B1856	6230	1856	Climate Control Air Temperature Internal Sensor Motor Circuit Short To Ground
B1857	6231	1857	Climate Control On/Off Switch Circuit Failure
B1858	6232	1858	Climate Control A/C Pressure Switch Circuit Failure

B1859	6233	1859	Climate Control A/C Pressure Switch Circuit Open
B1860	6240	1860	Climate Control A/C Pressure Switch Circuit Short To Battery
B1861	6241	1861	Climate Control A/C Pressure Switch Circuit Short To Ground
B1862	6242	1862	Climate Control A/C Lock Sensor Failure
B1863	6243	1863	Ground ECU Circuit Open
B1864	6244	1864	Battery Power Supply ECU Circuit Failure
B1865	6245	1865	Battery Power Supply ECU Circuit Open
B1866	6246	1866	Battery Power Supply ECU Circuit Short To Battery
B1867	6247	1867	Battery Power Supply ECU Circuit Short To Ground
B1868	6248	1868	Lamp Air Bag Warning Indicator Circuit Failure
B1869	6249	1869	Lamp Air Bag Warning Indicator Circuit Open
B1870	6256	1870	Lamp Air Bag Warning Indicator Circuit Short To Battery
B1871	6257	1871	Passenger Air Bag Disable Module Fault
B1872	6258	1872	Turn Signal / Hazard Power Feed Circuit Short To Battery
B1873	6259	1873	Turn Signal / Hazard Power Feed Circuit Short To Ground
B1874	6260	1874	Cellular Phone Handset Not Present
B1875	6261	1875	Turn Signal / Hazard Switch Signal Circuit Failure
B1876	6262	1876	Seatbelt Driver Pretensioner Circuit Failure
B1877	6263	1877	Seatbelt Driver Pretensioner Circuit Open
B1878	6264	1878	Seatbelt Driver Pretensioner Circuit Short to Battery
B1879	6265	1879	Seatbelt Driver Pretensioner Circuit Short to Ground
B1880	6272	1880	Seatbelt Passenger Pretensioner Circuit Failure
B1881	6273	1881	Seatbelt Passenger Pretensioner Circuit Open
B1882	6274	1882	Seatbelt Passenger Pretensioner Circuit Short to Battery
B1883	6275	1883	Seatbelt Passenger Pretensioner Circuit Short to Ground
B1884	6276	1884	PAD Warning Lamp Inoperative
B1885	6277	1885	Seatbelt Driver Pretensioner Circuit Resistance Low on Squib
B1886	6278	1886	Seatbelt Passenger Pretensioner Circuit Resistance Low on Squib
B1887	6279	1887	Air Bag Driver Circuit Resistance Low or Shorted Together
B1888	6280	1888	Air Bag Passenger Circuit Resistance Low or Shorted Together
B1889	6281	1889	Passenger Airbag Disable Module Sensor Obstructed
B1890	6288	1890	PAD Warning Lamp Circuit Short to Battery
B1891	6289	1891	Air Bag Tone Warning Indicator Circuit Short to Battery
B1892	6290	1892	Air Bag Tone Warning Indicator Circuit Failure
B1893	6291	1893	GPS Antenna Open Circuit
B1894	6292	1894	Wiper Rear Motor Speed Sense Circuit Failure
B1895	6293	1895	Driver's / Passenger's Door Ajar Output Circuit Failure
B1896	6294	1896	Driver's / Passenger's Door Ajar Output Circuit Short to Battery
B1897	6295	1897	Horn Switch Circuit Failure
B1898	6296	1898	Chime Input #2 Circuit Short to Ground
B1899	6297	1899	Microphone Input Signal Circuit Open
B1900	6400	1900	Driver Side Airbag Fault
B1901	6401	1901	Air Bag Crash Sensor #1 Feed/Return Circuit Short To Ground
B1902	6402	1902	Air Bag Crash Sensor #1 Ground Circuit Failure
B1903	6403	1903	Air Bag Crash Sensor #1 Ground Circuit Short To Battery
B1904	6404	1904	Air Bag Crash Sensor #2 Feed/Return Circuit Failure
B1905	6405	1905	Air Bag Crash Sensor #2 Feed/Return Circuit Short To Battery
B1906	6406	1906	Air Bag Crash Sensor #2 Feed/Return Circuit Short To Ground
B1907	6407	1907	Air Bag Crash Sensor #2 Ground Circuit Failure
B1908	6408	1908	Air Bag Crash Sensor #2 Ground Circuit Short To Battery
B1909	6409	1909	Air Bag Crash Sensor #2 Ground Circuit Short To Ground

B1910	6416	1910	Air Bag Diagnostic Monitor Ground Circuit Failure	B1961	6497	1961	Seat Recline Forward/Backward Potentiometer Feedback Circuit Short To
B1911	6417	1911	Air Bag Diagnostic Monitor Ground Circuit Short To Battery	Ground			
B1912	6418	1912	Air Bag Diagnostic Monitor Ground Circuit Short To Ground	B1962	6498	1962	Seat Horizontal Forward/Rearward Potentiometer Feedback Circuit Failure
B1913	6419	1913	Air Bag Driver/Passenger Circuit Short To Ground	B1963	6499	1963	Seat Horizontal Forward/Rearward Potentiometer Feedback Circuit Open
B1914	6420	1914	Air Bag Crash Sensors #1 / #2 Circuit Short To Ground	B1964	6500	1964	Seat Horizontal Forward/Rearward Potentiometer Feedback Circuit Short To
B1915	6421	1915	Air Bag Driver Circuit Failure	Battery			
B1916	6422	1916	Air Bag Driver Circuit Short To Battery	B1965	6501	1965	Seat Horizontal Forward/Rearward Potentiometer Feedback Circuit Short To
B1917	6423	1917	Air Bag Memory Clear Circuit Failure	Ground			
B1918	6424	1918	Air Bag Memory Clear Circuit Open	B1966	6502	1966	A/C Post Heater Sensor Circuit Failure
B1919	6425	1919	Air Bag Memory Clear Circuit Short To Battery	B1967	6503	1967	A/C Post Heater Sensor Circuit Short To Ground
B1920	6432	1920	Air Bag Passenger Circuit Failure	B1968	6504	1968	A/C Water Pump Detection Circuit Failure
B1921	6433	1921	Air Bag Diagnostic Monitor Ground Circuit Open	B1969	6505	1969	A/C Clutch Magnetic Control Circuit Failure
B1922	6434	1922	Air Bag Safing Sensor Output Circuit Short To Battery	B1970	6512	1970	Passenger Seatback Forward Switch Circuit Short to Ground
B1923	6435	1923	Air Bag Memory Clear Circuit Short To Ground	B1971	6513	1971	Passenger Seatback Rearward Switch Circuit Short to Ground
B1924	6436	1924	Air Bag Internal Diagnostic Monitor Fault or System Disarm Fault	B1972	6514	1972	Passenger Rear Seat Up Switch Circuit Short to Battery
B1925	6437	1925	Air Bag Passenger Circuit Short To Battery	B1973	6515	1973	Passenger Rear Seat Down Switch Circuit Short to Battery
B1926	6438	1926	Air Bag Passenger Pressure Switch Circuit Failure	B1974	6516	1974	Passenger's Seat Recline Forward Switch Circuit Short to Battery
B1927	6439	1927	Passenger Side Airbag Fault	B1975	6517	1975	Passenger's Seat Recline Back Switch Circuit Short to Battery
B1928	6440	1928	Air Bag Safing Sensor Output Circuit Failure	B1976	6518	1976	Passenger's Seat Forward Switch Circuit Short to Battery
B1929	6441	1929	Air Bag Safing Sensor Output Circuit Open	B1977	6519	1977	Passenger's Front Seat Up Switch Circuit Short to Battery
B1930	6448	1930	Air Bag Safing Sensor Output Circuit Short To Ground	B1978	6520	1978	Passenger's Front Seat Down Switch Circuit Short to Battery
B1931	6449	1931	Air Bag Crash Sensor #1 Feed/Return Circuit Failure	B1979	6521	1979	Passenger Seat Rearward Switch Circuit Short to Battery
B1932	6450	1932	Air Bag Driver Circuit Open	B1980	6528	1980	Bulb - Outage Condition Detected
B1933	6451	1933	Air Bag Passenger Circuit Open	B1981	6529	1981	Memory Off Switch Circuit Short to Battery
B1934	6452	1934	Air Bag Driver Inflator Circuit Resistance Low on Squib	B1982	6530	1982	Driver's Door Unlock Relay Circuit Failure
B1935	6453	1935	Air Bag Passenger Inflator Circuit Resistance Low on Squib	B1983	6531	1983	Driver's Door Unlock Relay Circuit Short to Battery
B1936	6454	1936	Air Bag Driver Circuit Short To Ground	B1984	6532	1984	Seat Switch Lumbar Inflate Circuit Failure
B1937	6455	1937	Air Bag Passenger Pressure Switch Circuit Open	B1985	6533	1985	Seat Switch Lumbar Deflate Circuit Failure
B1938	6456	1938	Air Bag Passenger Circuit Short To Ground	B1986	6534	1986	Driver's Seat Seatback Autoglide Rearward Switch Circuit Failure
B1939	6457	1939	Air Bag Passenger Pressure Switch Circuit Short To Ground	B1987	6535	1987	Pedal Forward / Rearward Motor Stalled
B1941	6465	1941	Air Bag Crash Sensor #1 Feed/Return Circuit Open	B1988	6536	1988	Pedal Position Forward Switch Circuit Short to Battery
B1942	6466	1942	Air Bag Crash Sensor #2 Feed/Return Circuit Open	B1989	6537	1989	Pedal Position Rearward Switch Circuit Short to Battery
B1943	6467	1943	Air Bag Crash Sensor #1 Ground Circuit Short To Ground	B1990	6544	1990	Pedal Forward / Rearward Potentiometer Feedback Circuit Failure
B1944	6468	1944	Air Bag Crash Sensor #1 Ground Circuit Open	B1991	6545	1991	Pedal Forward / Rearward Potentiometer Feedback Circuit Short to Battery
B1945	6469	1945	Air Bag Crash Sensor #2 Ground Circuit Open	B1992	6546	1992	Driver Side, Side mount Airbag Circuit Short to Vbatt
B1946	6470	1946	Climate Control A/C Post Evaporator Sensor Circuit Failure	B1993	6547	1993	Driver Sid, Side mount Airbag Circuit Short to Ground
B1947	6471	1947	Climate Control A/C Post Evaporator Sensor Circuit Short To Ground	B1994	6548	1994	Driver Sid, Side mount Airbag Circuit Open
B1948	6472	1948	Climate Control Water Temperature Sensor Circuit Failure	B1995	6549	1995	Driver Sid, Side mount Airbag Low resistance on Squib
B1949	6473	1949	Climate Control Water Temperature Sensor Circuit Short To Ground	B1996	6550	1996	Passenger Sid, Side mount Airbag Circuit Short to Vbatt
B1950	6480	1950	Seat Rear Up/Down Potentiometer Feedback Circuit Failure	B1997	6551	1997	Passenger Sid, Side mount Airbag Circuit Short to Ground
B1951	6481	1951	Seat Rear Up/Down Potentiometer Feedback Circuit Open	B1998	6552	1998	Passenger Sid, Side mount Airbag Circuit Open
B1952	6482	1952	Seat Rear Up/Down Potentiometer Feedback Circuit Short To Battery	B1999	6553	1999	Passenger Sid, Side mount Airbag Low resistance on Squib
B1953	6483	1953	Seat Rear Up/Down Potentiometer Feedback Circuit Short To Ground	B2100	8448	2100	Door Driver Key Cylinder Switch Failure
B1954	6484	1954	Seat Front Up/Down Potentiometer Feedback Circuit Failure	B2101	8449	2101	Head Rest Switch Circuit Failure
B1955	6485	1955	Seat Front Up/Down Potentiometer Feedback Circuit Open	B2102	8450	2102	Antenna Circuit Short to Ground
B1956	6486	1956	Seat Front Up/Down Potentiometer Feedback Circuit Short To Battery	B2103	8451	2103	Antenna Not Connected
B1957	6487	1957	Seat Front Up/Down Potentiometer Feedback Circuit Short To Ground	B2104	8452	2104	Door Passenger Key Cylinder Switch Failure
B1958	6488	1958	Seat Recline Forward/Backward Potentiometer Feedback Circuit Failure	B2105	8453	2105	Throttle Position Input Out of Range Low
B1959	6489	1959	Seat Recline Forward/Backward Potentiometer Feedback Circuit Open	B2106	8454	2106	Throttle Position Input Out of Range High
B1960	6496	1960	Seat Recline Forward/Backward Potentiometer Feedback Circuit Short To	B2107	8455	2107	Front Wiper Motor Relay Circuit Short to Vbatt
Battery				B2108	8456	2108	Trunk Key Cylinder Switch Failure

B2109	8457	2109	Heated Wind Shield Relay Short to Vbatt (changed from Failure 2/6/97)	B2168	8552	2168	Unable to confirm Unlock Condition
B2110	8464	2110	Front Wiper Motor Relay Circuit Open (changed from Failure 2/6/97)	B2169	8553	2169	Unable to confirm lock Condition
B2111	8465	2111	All Door Lock Input Short to Ground	B2170	8560	2170	Steering Column Lock Switch Circuit Failure
B2112	8466	2112	Door Driver Set Switch Stuck Failure	B2172	8562	2172	Inertia Switch input Circuit Open
B2113	8467	2113	Heated Windshield Input Short to Ground	B2174	8564	2174	Window Driver Rear Remote Up Switch Short to Battery
B2114	8468	2114	Front Washer Input Short to Ground	B2175	8565	2175	A/C Request Signal Circuit Short to Ground
B2115	8469	2115	Rear Washer Input Short to Ground	B2176	8566	2176	Overdrive switch circuit short to Vbatt
B2116	8470	2116	Door Driver Reset Switch Stuck Failure	B2177	8567	2177	Interior Scanning Sensor Circuit Failure
B2117	8471	2117	Driver Side, Side mount Airbag Low capacitance on Squib	B2178	8568	2178	Window Driver Rear Remote Down Switch Short to Battery
B2118	8472	2118	Passenger Sid, Side mount Airbag Low capacitance on Squib	B2179	8569	2179	Front Wiper Select Switch "A" Short to Ground
B2119	8473	2119	Compressor Failure	B2180	8576	2180	Front Wiper Select Switch "B" Short to Ground
B2120	8480	2120	Door Passenger Set Switch Stuck Failure	B2181	8577	2181	Front Wiper Select Switch "C" Short to Ground
B2122	8482	2122	Driver Side Satellite Communication Circuit Short to Ground	B2182	8578	2182	Window Passenger Front Remote Up Switch Short to Battery
B2123	8483	2123	Passenger Side Satellite Communication Circuit Short to Ground	B2183	8579	2183	Front Wiper Select Switch "H" Short to Ground
B2124	8484	2124	Door Passenger Reset Switch Stuck Failure	B2184	8580	2184	Front Wiper Select Switch "W" Short to Ground
B2128	8488	2128	Central Lock Motor Failure	B2185	8581	2185	Rear Wiper Select Switch "D" Short to Ground
B2129	8489	2129	Central Lock Feedback Failure	B2186	8582	2186	Window Passenger Front Remote Down Switch Short to Battery
B2130	8496	2130	Double Lock Timeout Failure	B2187	8583	2187	Rear Wiper Select Switch "B" Short to Ground
B2131	8497	2131	Double Lock Feedback Failure	B2188	8584	2188	Rear Wiper Select Switch "E" Short to Ground
B2132	8498	2132	Dimmer switch Circuit Short to Gnd	B2190	8592	2190	Window Passenger Rear Remote Up Switch Short to Battery
B2133	8499	2133	Brake Motor Warning lamp Circuit Failure	B2194	8596	2194	Window Passenger Rear Remote Down Switch Short to Battery
B2134	8500	2134	Brake Motor Warning lamp Circuit Short to Vbatt	B2195	8597	2195	Driver Window Up / Down Power Circuit Short to Ground
B2135	8501	2135	Park Brake Applied Warning Lamp Circuit Failure	B2196	8598	2196	Passenger Window Up / Down Power Circuit Short to Ground
B2136	8502	2136	Park Brake Applied Warning Lamp Circuit Short To Battery	B2197	8599	2197	TV Module Error
B2139	8505	2139	Data Mismatch (receive data does not match what was expected)	B2198	8600	2198	TrafficMaster Module Error
B2141	8513	2141	NVM Configuration Failure	B2199	8601	2199	VICS Module Error
B2142	8514	2142	NVM TIC Failure	B2200	8704	2200	No Communication to TV Module (No Fitting of TV)
B2143	8515	2143	NVM Memory Failure	B2201	8705	2201	No Communication With Traffic MasterModule
B2144	8516	2144	NVM Alarm Data Failure	B2202	8706	2202	No Communication to VICS Module (No Fitting of VICS)
B2145	8517	2145	NVM RF HR Failure	B2203	8707	2203	CD-ROM Error
B2146	8518	2146	Seat Recline Motor Position Out of Range	B2204	8708	2204	GPS Antenna Connection Open or Short
B2148	8520	2148	PWM Input Circuit Failure	B2205	8709	2205	GPS Receiver Error
B2149	8521	2149	Seat Front Vertical Motor Position Out of Range	B2206	8710	2206	Gyroscope Error
B2150	8528	2150	Power Supply #1 Circuit Short to Ground	B2207	8711	2207	ECU ROM Checksum Error
B2151	8529	2151	Power Supply #2 Circuit Short to Ground	B2208	8712	2208	Communication Link to Display and Switch Module Error
B2152	8530	2152	Seat Rear Vertical Motor Position Out of Range	B2209	8713	2209	Interior Lamp Override Switch Open Circuit
B2153	8531	2153	Rear Echo Sensor Circuit Failure	B2210	8720	2210	Interior Lamp Override Switch Short to Ground
B2154	8532	2154	Front Echo Sensor Circuit Failure	B2211	8721	2211	Low Coolant Lamp Output Circuit Short to Battery
B2155	8533	2155	Seat Horizontal Motor Position Out of Range	B2214	8724	2214	Window Passenger Front Up Switch Short to Battery
B2156	8534	2156	Rear Doppler Sensor Circuit Failure	B2215	8725	2215	Window Passenger Front Down Switch Short to Battery
B2157	8535	2157	Front Doppler Sensor Circuit Failure	B2219	8729	2219	Window Driver Front Current Feedback Exceeded
B2158	8536	2158	Seat Recline Motor Memory Position Out of Range	B2220	8736	2220	Window Driver Rear Current Feedback Exceeded
B2159	8537	2159	Memory #1 output Short to Ground	B2221	8737	2221	Window Passenger Front Current Feedback Exceeded
B2160	8544	2160	Memory #1 output Short to VBatt	B2222	8738	2222	Window Passenger Rear Current Feedback Exceeded
B2161	8545	2161	Seat Front Vertical Motor Memory Position Out of Range	B2223	8739	2223	Mirror Driver Drive Circuit Failure
B2162	8546	2162	Data Mismatch #2 (receive data does not match what was expected)	B2224	8740	2224	Mirror Passenger Drive Circuit Failure
B2163	8547	2163	Clutch Position Fault	B2225	8741	2225	Front Crash Sensor Mount Fault
B2164	8548	2164	Seat Rear Vertical Motor Memory Position Out of Range	B2226	8742	2226	Front Crash Sensor Internal Fault
B2165	8549	2165	Gear shift position Fault	B2227	8743	2227	Front Crash Sensor Driver Communications Fault
B2166	8550	2166	Gear select position Fault	B2228	8744	2228	Air Bag Driver Circuit Short to Ground - Loop #2
B2167	8551	2167	Seat Horizontal Motor Memory Position Out of Range	B2229	8745	2229	Air Bag Passenger Circuit Short to Ground - Loop #2

B2230	8752	2230	Air Bag Driver Circuit Short to Battery - Loop #2	B2331	9009	2331	Column Reach Feedback Potentiometer Circuit Short to Ground
B2231	8753	2231	Air Bag Passenger Circuit Short to Battery - Loop #2	B2332	9010	2332	Column Tilt Feedback Potentiometer Circuit Failure
B2232	8754	2232	Air Bag Driver Circuit Open - Loop #2	B2333	9011	2333	Column Tilt Feedback Potentiometer Circuit Open
B2233	8755	2233	Air Bag passenger Circuit Open - Loop #2	B2334	9012	2334	Column Tilt Feedback Potentiometer Circuit Short to Battery
B2234	8756	2234	Air Bag Driver Inflator Circuit Resistance Low on Squib - Loop #2	B2335	9013	2335	Column Tilt Feedback Potentiometer Circuit Short to Ground
B2235	8757	2235	Air Bag Passenger Inflator Circuit	B2336	9014	2336	Mirror Switch Assembly Circuit Failure
B2236	8758	2236	Weak or Defected Electric Vehicle Battery Module Fault	B2337	9015	2337	Mirror Switch Assembly Circuit Open
B2237	8759	2237	Vehicle Signal indicating Park While VSS Present	B2338	9016	2338	Mirror Switch Assembly Circuit Short to Battery
B2238	8760	2238	Power Cable For Power Sliding Door Broken	B2339	9017	2339	Mirror Switch Assembly Circuit Short to Ground
B2239	8761	2239	Rear Cargo Door Set Switch Stuck (Short to Ground)	B2340	9024	2340	Column Reach Motor Stalled
B2240	8768	2240	Rear Cargo Door Reset Switch Stuck (Short to Ground)	B2341	9025	2341	Column Tilt Motor Stalled
B2241	8769	2241	Rear Cargo Door Lock Circuit Short to Ground	B2342	9026	2342	Seat Switch Reference Voltage Positive Common Open Circuit
B2242	8770	2242	Rear Cargo Door Unlock Circuit Open	B2343	9027	2343	Seat Switch Reference Voltage Positive Common Supply Low Voltage
B2243	8771	2243	Driver Rear Door Ajar Circuit Open	B2344	9028	2344	Seat Switch Reference Voltage Positive Common Supply Voltage Fault
B2244	8772	2244	Driver Sliding Door Ajar Circuit Short to GND	B2345	9029	2345	Seat Switch Reference Voltage Negative Common Open Circuit
B2245	8773	2245	Passenger Rear Door Ajar Circuit Open	B2346	9030	2346	Mirror Switch Reference Voltage Positive Common Open Circuit
B2246	8774	2246	Passenger Sliding Door Ajar Circuit Short to GND	B2347	9031	2347	Mirror Switch Reference Voltage Positive Common Supply Low Voltage
B2247	8775	2247	EV Battery Pack Temperature Fault	B2348	9032	2348	Mirror Switch Reference Voltage Positive Common Supply Voltage Fault
B2248	8776	2248	Heated Windshield Relay Coil Circuit Failure	B2349	9033	2349	Mirror Switch Reference Voltage Negative Common Open Circuit
B2249	8777	2249	Head Lamp Relay Coil Short to Battery	B2350	9040	2350	Steering Column Switch Circuit Short to Battery
B2250	8784	2250	All Doors Unlock Relay Circuit Failure	B2351	9041	2351	Steering Column Switch Circuit Failure
B2251	8785	2251	Parklamp Output Relay Driver Circuit Failure	B2352	9042	2352	Driver Memory Power Switch Indicator Circuit Short to Battery
B2252	8786	2252	Parklamp Output Relay Dirver Short to Battery	B2353	9043	2353	Driver Mirror Power Driver Circuit Short Ground
B2300	8960	2300	Seat Driver Memory Position Error	B2354	9044	2354	Driver Mirror Horizontal / Vertical Feedback Potentiometer Circuit Open
B2301	8961	2301	Seat Passenger Memory Position Error	B2355	9045	2355	Passenger Mirror Horizontal / Vertical Feedback Potentiometer Circuit Open
B2302	8962	2302	Seat Headrest Feedback Potentiometer Circuit Failure	B2357	9047	2357	Driver Window Down Current Sense Low Circuit Failure
B2303	8963	2303	Seat Headrest Feedback Potentiometer Circuit Open	B2362	9058	2362	Remote Open/Close signal Circuit Short to Ground
B2304	8964	2304	Seat Headrest Feedback Potentiometer Circuit Short to Battery	B2363	9059	2363	Optical Sensor System Failure
B2305	8965	2305	Seat Headrest Feedback Potentiometer Circuit Short to Ground	B2364	9060	2364	Fuel Filler Door Circuit Open
B2306	8966	2306	Seat Headrest Motor Stalled	B2365	9061	2365	B-pillar Power Sliding Door Open/Close Switch Input Ckt Short to Gnd
B2310	8976	2310	Mirror Driver Memory Position Error	B2366	9062	2366	IP Power Sliding Door Open/Close switch Ckt Short to Gnd
B2311	8977	2311	Mirror Passenger Memory Position Error	B2367	9063	2367	Power Sliding Door Override Switch Input Ckt Short to Gnd
B2312	8978	2312	Mirror Passenger Horizontal Feedback Potentiometer Circuit Failure	B2368	9064	2368	Steering Column Switch Circuit Out of Range
B2313	8979	2313	Mirror Passenger Horizontal Feedback Potentiometer Circuit Open	B2369	9065	2369	Chime OUTPUT Request Ckt Short to Ground
B2314	8980	2314	Mirror Passenger Horizontal Feedback Potentiometer Circuit Short to Battery	B2373	9075	2373	LED #1 Circuit Short to Battery
B2315	8981	2315	Mirror Passenger Horizontal Feedback Potentiometer Circuit Short to Ground	B2374	9076	2374	Power Sliding Detent (Latch) Circuit Failure
B2316	8982	2316	Mirror Passenger Vertical Feedback Potentiometer Circuit Failure	B2380	9088	2380	Heater Coolant Temp sensor circuit Short to GND
B2317	8983	2317	Mirror Passenger Vertical Feedback Potentiometer Circuit Open	B2381	9089	2381	Heater Coolant Temp sensor circuit Open
B2318	8984	2318	Mirror Passenger Vertical Feedback Potentiometer Circuit Short to Battery	B2384	9092	2384	Audio Reverse Aid Mute Input Ckt Failure
B2319	8985	2319	Mirror Passenger Vertical Feedback Potentiometer Circuit Short to Ground	B2385	9093	2385	Audio Navigation Mute Input Ckt Failure
B2320	8992	2320	Mirror Driver Horizontal Feedback Potentiometer Circuit Failure	B2401	9217	2401	Audio Tape Deck Mechanism Fault
B2321	8993	2321	Mirror Driver Horizontal Feedback Potentiometer Circuit Open	B2402	9218	2402	Audio CD/DJ Thermal Shutdown Fault
B2322	8994	2322	Mirror Driver Horizontal Feedback Potentiometer Circuit Short to Battery	B2403	9219	2403	Audio CD/DJ Internal Fault
B2323	8995	2323	Mirror Driver Horizontal Feedback Potentiometer Circuit Short to Ground	B2404	9220	2404	Audio Steering Wheel Switch Circuit Fault
B2324	8996	2324	Mirror Driver Vertical Feedback Potentiometer Circuit Failure	B2405	9221	2405	Audio Single-Disc CD Player Thermal Shutdown Fault
B2325	8997	2325	Mirror Driver Vertical Feedback Potentiometer Circuit Open	B2406	9222	2406	Audio Single-Disc CD Player Internal Fault
B2326	8998	2326	Mirror Driver Vertical Feedback Potentiometer Circuit Short to Battery	B2416	9238	2416	Climate Control Recirculation Actuator Out of Limits
B2327	8999	2327	Mirror Driver Vertical Feedback Potentiometer Circuit Short to Ground	B2425	9253	2425	Remote Keyless Entry Out of Synchronization
B2328	9000	2328	Column Reach Feedback Potentiometer Circuit Failure	B2426	9254	2426	Passenger Solar Radiation Sensor Circuit Open
B2329	9001	2329	Column Reach Feedback Potentiometer Circuit Open	B2427	9255	2427	Passenger Solar Radiation Sensor Circuit Short to Ground
B2330	9008	2330	Column Reach Feedback Potentiometer Circuit Short to Battery	B2428	9256	2428	A/C Post Heater Sensor #2 Circuit Failure

B2429	9257	2429	A/C Post Heater Sensor #2 Circuit Short to Ground	B2481	9345	2481	Convertible Top Up/Down switch Fault
B2431	9265	2431	Transponder Programming Failed	B2482	9346	2482	RF CORNER LAMP OUTPUT Ckt Short to Battery
B2432	9266	2432	Drivers Seat Belt Buckle Switch Circuit Open	B2483	9347	2483	Enable Signal Open Circuit
B2433	9267	2433	Drivers Seat Belt Buckle Switch Circuit Short to Battery	B2484	9348	2484	Disable Signal Short to Ground
B2434	9268	2434	Drivers Seat Belt Buckle Switch Circuit Short to Ground	B2485	9349	2485	LF SIDE REPEATER LAMP OUTPUT Ckt Short to Battery
B2435	9269	2435	Drivers Seat Belt Buckle Switch Resistance out of Range	B2487	9351	2487	RF SIDE REPEATER LAMP OUTPUT Ckt Short to Battery
B2436	9270	2436	Passengers Seat Belt Buckle Switch Circuit Open	B2489	9353	2489	UNDERHOOD LAMP OUTPUT CIRCUIT Failure
B2437	9271	2437	Passengers Seat Belt Buckle Switch Circuit Short to Battery	B2490	9360	2490	UNDERHOOD LAMP OUTPUT CIRCUIT Short to Battery
B2438	9272	2438	Passengers Seat Belt Buckle Switch Circuit Short to Ground	B2491	9361	2491	RF PARK LAMP OUTPUT CIRCUIT Short to Battery
B2439	9273	2439	Passengers Seat Belt Buckle Switch Resistance out of Range	B2492	9362	2492	Already Programmed (Test Mode DTC Only !!!)
B2440	9280	2440	Passenger Sid, Side crash sensor mount fault	B2493	9363	2493	LF PARK LAMP OUTPUT CIRCUIT Short to Battery
B2441	9281	2441	Driver Sid, Side crash sensor mount fault	B2494	9364	2494	ANTI THEFT HORN OUTPUT CIRCUIT Short to Batt
B2442	9282	2442	Intrusion Sensor Fault	B2495	9365	2495	ANTI THEFT HORN OUTPUT CIRCUIT Failure
B2443	9283	2443	Powertrain Performance Mode Switch Circuit failure	B2496	9366	2496	ANTI THEFT HORN OUTPUT CIRCUIT Short to Gnd
B2444	9284	2444	Driver Side Crash Sensor Internal Fault	B2499	9369	2499	COURTESY LAMP OUTPUT Failure
B2445	9285	2445	Passenger Side Crash Sensor Internal Fault	B2500	9472	2500	COURTESY LAMP OUTPUT Ckt Short to Battery
B2446	9286	2446	RESCU/VEMS Input Circuit Open	B2501	9473	2501	LF LAMP LOW BEAM CIRCUIT Failure
B2447	9287	2447	RESCU/VEMS Input Circuit Short to Battery	B2502	9474	2502	LF LAMP LOW BEAM CIRCUIT Short to Battery
B2448	9288	2448	RESCU/VEMS Input Circuit Short to Ground	B2503	9475	2503	RF LAMP LOW BEAM CIRCUIT Failure
B2449	9289	2449	Aux Heater Glow Plug Circuit Short to Ground	B2504	9476	2504	RF LAMP LOW BEAM CIRCUIT Short to Battery
B2450	9296	2450	Aux Heater Glow Plug Circuit Open	B2505	9477	2505	LF LAMP HIGH BEAM CIRCUIT Failure
B2451	9297	2451	Aux Heater Fuel Pump Circuit Short to Ground	B2506	9478	2506	LF LAMP HIGH BEAM CIRCUIT Short to Battery
B2452	9298	2452	Aux Heater Fuel Pump Circuit Open	B2507	9479	2507	RF LAMP HIGH BEAM CIRCUIT Failure
B2453	9299	2453	Aux Heater Blower Fan Circuit Short to Ground	B2508	9480	2508	RF LAMP HIGH BEAM CIRCUIT Short to Battery
B2454	9300	2454	Aux Heater Blower Fan Circuit Open	B2509	9481	2509	Rear Fog Lamp Switch Circuit Failure
B2455	9301	2455	Aux Heater Blower Faulted	B2510	9488	2510	Main Blower Motor Relay Circuit Short to Battery
B2456	9302	2456	Aux Heater Coolant Sensor Circuit Short to Ground	B2511	9489	2511	Horn Output Relay Circuit Short to Battery
B2457	9303	2457	Aux Heater Coolant Sensor Circuit Open	B2512	9490	2512	Front Fog Lamp Relay Ckt Short to Battery
B2458	9304	2458	Aux Heater Overheat Sensor Circuit Short to Ground	B2513	9491	2513	Blower (Fan) Circuit Failure
B2459	9305	2459	Aux Heater Overheat Sensor Circuit Open	B2514	9492	2514	Blower (Fan) Circuit Short to Vbatt
B2460	9312	2460	Aux Heater Flame Sensor Circuit Short to Ground	B2515	9493	2515	Heater Blower Relay Circuit Failure
B2461	9313	2461	Aux Heater Flame Sensor Circuit Open	B2516	9494	2516	Blower Control Circuit Failure
B2462	9314	2462	Aux Heater Flame Out Fault	B2517	9495	2517	Emergency Power Off System Faulted
B2463	9315	2463	Aux Heater Overheat Fault	B2518	9496	2518	Compressor Overtemp Fault
B2464	9316	2464	Aux Heater Start Time Exceeded	B2519	9497	2519	High Mount Stop Lamp Circuit Failure
B2465	9317	2465	Aux Heater Start Counter Overrun/System Locked (same as below ?)	B2520	9504	2520	High Mount Stop Lamp Circuit Short to Battery
B2466	9318	2466	Aux Heater Overheat Counter Overrun/System Locked	B2523	9507	2523	License Lamp Circuit Failure
B2467	9319	2467	Aux Heater Cool Down Time Exceeded (may be con to a453-5)	B2524	9508	2524	License Lamp Circuit Short to Battery
B2468	9320	2468	Aux Heater Coolant Pump Circuit Short to Ground	B2525	9509	2525	Left Rear Backup Lamp Circuit Failure
B2469	9321	2469	Aux Heater Coolant Pump Circuit Open	B2526	9510	2526	Left Rear Backup Lamp Circuit Short to Battery
B2470	9328	2470	Interior Fan Control Circuit Short to Ground	B2527	9511	2527	Left Rear Stop lamp Circuit Failure
B2471	9329	2471	Interior Fan Control Circuit Open	B2528	9512	2528	Left Rear Stop lamp Circuit Short to Battery
B2472	9330	2472	Fog Lamp Switch Failure	B2529	9513	2529	Left Rear Turn Lamp Circuit Failure
B2473	9331	2473	Passenger Door Disarm Switch ckt Short to Ground	B2530	9520	2530	Left Rear Turn Lamp Circuit Short to Battery
B2474	9332	2474	Passenger Door Lock Switch Circuit Shorted to Ground	B2531	9521	2531	Right Rear Backup Lamp Circuit Failure
B2475	9333	2475	Passenger Door Unlock Switch Circuit Shorted to Ground	B2532	9522	2532	Right Rear Backup Lamp Circuit Short to Battery
B2476	9334	2476	RADIO PRESENT SWITCH Ckt Failure	B2533	9523	2533	Right Rear Stop lamp Circuit Failure
B2477	9335	2477	Module Configuration Failure	B2534	9524	2534	Right Rear Stop lamp Circuit Short to Battery
B2478	9336	2478	ANTI THEFT INPUT SIGNAL SHORT TO GROUND	B2535	9525	2535	Right Rear Turn Lamp Circuit Failure
B2479	9337	2479	BRAKE PARK SWITCH CIRCUIT SHORT TO GROUND	B2536	9526	2536	Right Rear Turn Lamp Circuit Short to Battery
B2480	9344	2480	LF CORNER LAMP OUTPUT Ckt Short to Battery	B2539	9529	2539	Aux A/C Mode Position Reference Circuit Short to Ground



B2540	9536	2540	Aux A/C Mode Position Reference Circuit Short to Battery	B2606	9734	2606	A/C Temperature Sensor Out of Range
B2543	9539	2543	Aux A/C Control Switch Reference Circuit Short to Ground				
B2544	9540	2544	Aux A/C Control Switch Reference Circuit Short to Battery				
B2545	9541	2545	System Power Relay Circuit Short to Battery				
B2546	9542	2546	System Power Relay Circuit Failure				
B2550	9552	2550	LAMP DOME OUTPUT Circuit Short to Ground				
B2553	9555	2553	Disable Signal Output Circuit Short to Battery				
B2554	9556	2554	LAMP DOME OUTPUT Circuit Failure				
B2555	9557	2555	LAMP DOME OUTPUT Circuit Short to Battery				
B2556	9558	2556	Enable Signal Circuit Short to Battery				
B2557	9559	2557	Left Power Sliding Door Open/Close Output Circuit Short to Battery				
B2558	9560	2558	Right Power Sliding Door Open/Close Output Circuit Short to Battery				
B2559	9561	2559	Aux A/C Blower Motor Relay Circuit Short to Battery				
B2560	9568	2560	Aux A/C Blower Motor Relay Circuit Short to Ground				
B2561	9569	2561	Aux A/C Blower Speed 1 Circuit Failure				
B2562	9570	2562	Aux A/C Blower Speed 1 Circuit Short to Ground				
B2563	9571	2563	Aux A/C Blower Speed 2 Circuit Failure				
B2564	9572	2564	Aux A/C Blower Speed 2 Circuit Short to Ground				
B2565	9573	2565	Right Tail Lamp Circuit Failure				
B2566	9574	2566	Right Tail Lamp Circuit Short to Ground				
B2567	9575	2567	Reverse Mirror Output Circuit Failure				
B2568	9576	2568	Reverse Mirror Output Circuit Short to Ground				
B2569	9577	2569	Liftgate Disarm Switch Circuit Short to Ground				
B2570	9584	2570	Right Lamp Outage Signal Circuit Short to Ground				
B2571	9585	2571	Left Lamp Outage Signal Circuit Short to Ground				
B2580	9600	2580	Aux Blower Sense Switch Circuit Failure				
B2581	9601	2581	Passenger Seat Occupant Detection Circuit Short To Ground				
B2582	9602	2582	Passenger Seat Occupant Detection Circuit Open				
B2583	9603	2583	Child Seat Detection Circuit Short to Ground				
B2584	9604	2584	Child Seat Detection Circuit Open				
B2585	9605	2585	Anti Theft Input Signal Circuit Short To Battery				
B2586	9606	2586	Headlamp Mode Select Circuit Failure				
B2587	9607	2587	Passenger Seat Occupant Detection Circuit Short To Battery				
B2588	9608	2588	Child Seat Detection Circuit Short To Battery				
B2589	9609	2589	Unexpected Door Reversal During Close				
B2590	9616	2590	Vehicle Park/Speed Signal Circuit Failure				
B2591	9617	2591	Detent Signal Missing During Unlatch				
B2592	9618	2592	PSD Not Fully Closed (Module Commanded Successfully)				
B2593	9619	2593	Power Sliding Door Opened During Module Close Command				
B2594	9620	2594	No Movement Detected After an Unlatch During Power Open				
B2595	9621	2595	Anti Theft Input Signal Circuit Failure				
B2596	9622	2596	Headlamp Aim Output Relay Circuit Short To Battery				
B2597	9623	2597	Headlamp Aim Output Relay Circuit Failure				
B2598	9624	2598	Headlamp Relay Circuit Failure				
B2599	9625	2599	Tailgate Release Open Circuit				
B2600	9728	2600	Double Locking Door Motor Frozen				
B2601	9729	2601	No Latch Signal Sensed on Closing and Door Reversed				
B2602	9730	2602	Missing Latch Signal During Power Sliding Door Unlatch				
B2603	9731	2603	PSD Not Fully Closed During Self-Test				
B2604	9732	2604	Power Sliding Door On/Off Switch Open Circuit				
B2605	9733	2605	Disable Signal Open Circuit				

**Códigos C0:** En este caso encontramos los códigos exigidos por la norma

**Código Interpretación de la Avería**

**OBD**

C0035 - Left Front Wheel Speed Circuit Malfunction  
C0040 - Right Front Wheel Speed Circuit Malfunction  
C0041 - Right Front Wheel Speed Sensor Circuit Range/Performance (EBCM)  
C0045 - Left Rear Wheel Speed Circuit Malfunction  
C0046 - Left Rear Wheel Speed Sensor Circuit Range/Performance (EBCM)  
C0050 - Right Rear Wheel Speed Circuit Malfunction  
C0051 - LF Wheel Speed Sensor Circuit Range/Performance (EBCM)  
C0060 - Left Front ABS Solenoid #1 Circuit Malfunction  
C0065 - Left Front ABS Solenoid #2 Circuit Malfunction  
C0070 - Right Front ABS Solenoid #1 Circuit Malfunction  
C0075 - Right Front ABS Solenoid #2 Circuit Malfunction  
C0080 - Left Rear ABS Solenoid #1 Circuit Malfunction  
C0085 - Left Rear ABS Solenoid #2 Circuit Malfunction  
C0090 - Right Rear ABS Solenoid #1 Circuit Malfunction  
C0095 - Right Rear ABS Solenoid #2 Circuit Malfunction  
C0110 - Pump Motor Circuit Malfunction  
C0121 - Valve Relay Circuit Malfunction  
C0128 - Low Brake Fluid Circuit Low  
C0141 - Left TCS Solenoid #1 Circuit Malfunction  
C0146 - Left TCS Solenoid #2 Circuit Malfunction  
C0151 - Right TCS Solenoid #1 Circuit Malfunction  
C0156 - Right TCS Solenoid #2 Circuit Malfunction  
C0161 - ABS/TCS Brake Switch Circuit Malfunction  
C0221 - Right Front Wheel Speed Sensor Circuit Open  
C0222 - Right Front Wheel Speed Signal Missing  
C0223 - Right Front Wheel Speed Signal Erratic  
C0225 - Left Front Wheel Speed Sensor Circuit Open  
C0226 - Left Front Wheel Speed Signal Missing  
C0227 - Left Front Wheel Speed Signal Erratic  
C0229 - Drop Out of Front Wheel Speed Signals  
C0235 - Rear Wheel Speed Signal Circuit Open  
C0236 - Rear Wheel Speed Signal Circuit Missing  
C0237 - Rear Wheel Speed Signal Erratic  
C0238 - Wheel Speed Mismatch  
C0241 - EBCM Control Valve Circuit  
Electrónica del automóvil On Board Diagnostic II  
27  
C0245 - Wheel Speed Sensor Frequency Error  
C0254 - EBCM Control Valve Circuit  
C0265 - EBCM Relay Circuit  
C0266 - EBCM Relay Circuit  
C0267 - Pump Motor Circuit Open/Shorted  
C0268 - Pump Motor Circuit Open/Shorted  
C0269 - Excessive Dump/Isolation Time  
C0271 - EBCM Malfunction

C0272 - EBCM Malfunction  
C0273 - EBCM Malfunction  
C0274 - Excessive Dump/Isolation Time  
C0279 - Powertrain Configuration Not Valid  
C0281 - Brake Switch Circuit  
C0283 - Traction Switch Shorted to Ground  
C0284 - EBCM Malfunction  
C0286 - ABS Indicator Lamp Circuit Shorted to B+  
C0287 - Delivered Torque Circuit  
C0288 - Brake Warning Lamp Circuit Shorted to B+  
C0290 - Lost Communications With PCM  
C0292 - Lost Communications With PCM  
C0291 - Lost Communications With BCM  
C0297 - Powertrain Configuration Data Not Received  
C0298 - Powertrain Indicated Traction Control Malfunction  
C0300 - Rear Speed Sensor Malfunction  
C0305 - Front Speed Sensor Malfunction  
C0306 - Motor A or B Circuit  
C0308 - Motor A/B Circuit Low  
C0309 - Motor A/B Circuit High  
C0310 - Motor A/B Circuit Open  
C0315 - Motor Ground Circuit Open  
C0321 - Transfer Case Lock Circuit  
C0323 - T-Case Lock Circuit Low  
C0324 - T-Case Lock Circuit High  
C0327 - Encoder Circuit Malfunction  
C0357 - Park Switch Circuit High  
C0359 - Four Wheel Drive Low Range (4LO) Discrete Output Circuit  
C0362 - 4LO Discrete Output Circuit High  
C0367 - Front Axle Control Circuit High  
C0374 - General System Malfunction  
C0376 - Front/Rear Shaft Speed Mismatch  
C0379 - Front Axle System  
C0387 - Unable to Perform Shift  
C0472 - Steering Handwheel Speed Sensor Signal V Low  
C0473 - Steering Handwheel Speed Sensor Signal V High  
C0495 - EVO Tracking Error  
C0498 - Steering Assist Control Actuator Feed Circuit Low  
C0499 - Steering Assist Control Solenoid Feed Circuit High  
C0503 - Steering Assist Control Solenoid Return Circuit Low  
C0504 - Steering Assist Control Solenoid Return Circuit High  
C0550 - ECU Malfunction - internal write / checksum malfunction  
C0559 - EEPROM Checksum Error  
C0563 - Calibration ROM Checksum Error  
C0577 - Left Front Solenoid Circuit Low  
C0578 - Left Front Solenoid Circuit High  
C0579 - Left Front Solenoid Circuit Open  
C0582 - Right Front Solenoid Circuit Low  
C0583 - Right Front Solenoid Circuit High  
C0584 - Right Front Solenoid Circuit Open  
C0587 - Left Rear Solenoid Circuit Low

C0588 - Left Rear Solenoid Circuit High  
Electrónica del automóvil On Board Diagnostic II  
28  
C0589 - Left Rear Solenoid Circuit Open  
C0592 - Right Rear Solenoid Circuit Low  
C0593 - Right Rear Solenoid Circuit High  
C0594 - Right Rear Solenoid Circuit Open  
C0611 - VIN Information Error  
C0615 - Left Front Position Sensor Malfunction  
C0620 - Right Front Position Sensor Malfunction  
C0625 - Left Rear Position Sensor Malfunction  
C0628 - Level Control Position Sensor Circuit High  
C0630 - Right Rear Position Sensor Malfunction  
C0635 - Left Front Normal Force Circuit Malfunction  
C0638 - Left Front Normal Force Circuit High  
C0640 - Right Front Normal Force Circuit Malfunction  
C0643 - Right Front Normal Force Circuit High  
C0655 - Level Control Compressor Relay Malfunction  
C0657 - Level Control Compressor Circuit Low  
C0658 - Level Control Compressor Circuit High  
C0660 - Level Control Exhaust Valve Circuit Malfunction  
C0662 - Level Control Exhaust Valve Circuit Low  
C0663 - Level Control Exhaust Valve Circuit High  
C0665 - Chassis Pitch Signal Circuit  
C0690 - Damper Control Relay Circuit Malfunction  
C0691 - Damper Control Relay Circuit Range  
C0693 - Damper Control Relay Circuit High  
C0695 - Position Sensor Overcurrent (8 volt supply)  
C0696 - Position Sensor Overcurrent (5 volt supply)  
C0710 - Steering Position Signal Malfunction  
C0750 - Tire Pressure Monitor (TPM) system sensor not transmitting  
C0755 - Tire Pressure Monitor (TPM) system sensor not transmitting  
C0760 - Tire Pressure Monitor (TPM) system sensor not transmitting  
C0765 - Tire Pressure Monitor (TPM) system sensor not transmitting  
C0800 - Device Power #1 Circuit Malfunction  
C0896 - Electronic Suspension Control (ESC) voltage is outside the normal range of 9 to 15.5 volts

**Códigos C1:** En este caso se presentan los códigos C utilizados por Peugeot

**Código OBD**    **Código Avería**    **Código HEX**    **Interpretación de la Avería**

C1091	4241	1091	Speed Wheel Sensor All Coherency Failure
C1095	4245	1095	ABS Hydraulic Pump Motor Circuit Failure
C1096	4246	1096	ABS Hydraulic Pump Motor Circuit Open
C1097	4247	1097	ABS Hydraulic Pump Motor Circuit Short To Ground
C1098	4248	1098	ABS Hydraulic Pump Motor Circuit Short To Battery
C1100	4352	1100	ABS Pump Switch Circuit Failure
C1101	4353	1101	ABS Hydraulic Valve Circuit Failure
C1102	4354	1102	ABS Acceleration Switch Circuit Failure
C1103	4355	1103	ABS Hydraulic Brake Switch Circuit Failure
C1104	4356	1104	Traction Control Active Lamp - Circuit Short to Battery
C1105	4357	1105	Traction Control Disable Lamp - Circuit Short to Battery
C1106	4358	1106	Traction Control Disable Switch Circuit Short to Battery
C1107	4359	1107	ABS Function Enabled Input Circuit Failure
C1109	4361	1109	Speed Control Actuator Assembly Cable Release Failure
C1110	4368	1110	ABS Power Relay Coil Circuit Failure
C1111	4369	1111	ABS Power Relay Coil Open Circuit
C1112	4370	1112	ABS Power Relay Coil Short Circuit To Ground
C1113	4371	1113	ABS Power Relay Coil Short Circuit To Battery
C1114	4372	1114	ABS Power Relay Output Short Circuit To Ground
C1115	4373	1115	ABS Power Relay Output Short Circuit To Battery
C1116	4374	1116	Starter Motor Circuit Failure
C1117	4375	1117	RPM Input Circuit Failure
C1123	4387	1123	Vehicle Speed Sensor Input Short to Battery
C1124	4388	1124	Input shaft speed signal missing/faulted
C1125	4389	1125	Brake Fluid Level Sensor Input Circuit Failure
C1126	4390	1126	Cruise Control Command Switch Assembly Circuit Failure
C1127	4391	1127	Cruise Control Deactivator Brake Switch Circuit Failure
C1132	4402	1132	Clutch position ckt short to ground
C1133	4403	1133	Clutch position ckt short to battery
C1134	4404	1134	Gear Shift position short to ground
C1135	4405	1135	Gear Shift position short to battery
C1136	4406	1136	Gear Select position short to ground
C1137	4407	1137	ECU is Defective
C1138	4408	1138	Gear Select position short to Battery
C1139	4409	1139	Wheel Speed Sensor Center Tone Ring Missing Tooth Fault
C1140	4416	1140	Hydraulic Base Brake Failure
C1141	4417	1141	Wheel Speed Sensor LF Tone Ring Tooth Missing Fault
C1142	4418	1142	Wheel Speed Sensor RF Tone Ring Tooth Missing Fault
C1143	4419	1143	Wheel Speed Sensor LR Tone Ring Tooth Missing Fault
C1144	4420	1144	Wheel Speed Sensor RR Tone Ring Tooth Missing Fault
C1145	4421	1145	Speed Wheel Sensor RF Input Circuit Failure
C1146	4422	1146	Speed Wheel Sensor RF Circuit Open
C1148	4424	1148	Speed Wheel Sensor RF Coherency Fault
C1149	4425	1149	Hydraulic Fluid Pressure/ Flow Circuit Failure

C1150	4432	1150	Two Speed Rear Axle Input Switch Circuit Short to Vbatt
C1155	4437	1155	Speed Wheel Sensor LF Input Circuit Failure
C1156	4438	1156	Speed Wheel Sensor LF Circuit Open
C1157	4439	1157	Park Brake Actuator Assembly Switch Applied Circuit Failure
C1158	4440	1158	Speed Wheel Sensor LF Coherency Fault
C1159	4441	1159	Hydraulic Fluid Pressure/ Flow Circuit Short to Gnd
C1161	4449	1161	Air Pressure Low Circuit Short to Gnd
C1162	4450	1162	Park Brake Switch # 2 Released Circuit Failure
C1163	4451	1163	Park Brake Switch # 2 Applied Circuit Short to Gnd
C1164	4452	1164	Park Brake Actuator Assembly Switch Circuit Failure
C1165	4453	1165	Speed Wheel Sensor RR Input Circuit Failure
C1166	4454	1166	Speed Wheel Sensor RR Input Open Circuit
C1167	4455	1167	Park Brake Actuator Assembly Switch Released Circuit Short to Gnd
C1168	4456	1168	Speed Wheel Sensor RR Coherency Fault
C1169	4457	1169	ABS Fluid Dumping Exceeds Maximum Timing
C1170	4464	1170	PRNDL Switch Circuit Failure
C1172	4466	1172	Park Brake Switch # 1 Applied Circuit Failure
C1173	4467	1173	Park Brake Switch # 1 Released Circuit Short to Gnd
C1174	4468	1174	Park Brake Switch # 2 Applied Circuit Failure
C1175	4469	1175	Speed Wheel Sensor LR Input Circuit Failure
C1176	4470	1176	Speed Wheel Sensor LR Circuit Open
C1177	4471	1177	Park Brake Actuator Assembly Switch Released Circuit Failure
C1178	4472	1178	Speed Wheel Sensor LR Coherency Fault
C1179	4473	1179	Speed Control Actuator Assembly Cable Slack Failure
C1180	4480	1180	Park Brake Valve Solenoid #1 Sense Input Circuit Failure
C1181	4481	1181	Park Brake Valve Solenoid #1 Sense Input Circuit Short to Ground
C1182	4482	1182	Park Lamp Flash Relay Circuit Failure
C1183	4483	1183	Park Lamp Flash Relay Circuit Short to Battery
C1184	4484	1184	ABS System Is Not Operational
C1185	4485	1185	ABS Power Relay Output Circuit Failure
C1186	4486	1186	ABS Power Relay Output Open Circuit
C1187	4487	1187	Brake Fluid Level Sensor Input Open Circuit
C1188	4488	1188	Brake Fluid Level Sensor Input Short Circuit To Battery
C1189	4489	1189	Brake Fluid Level Sensor Input Short Circuit To Ground
C1190	4496	1190	Speed Wheel Sensor LF Input Short Circuit To Battery
C1191	4497	1191	Speed Wheel Sensor LF Input Short Circuit To Ground
C1192	4498	1192	Speed Wheel Sensor RF Input Short Circuit To Battery
C1193	4499	1193	Speed Wheel Sensor RF Input Short Circuit To Ground
C1194	4500	1194	ABS Outlet Valve Coil LF Circuit Failure
C1195	4501	1195	ABS Outlet Valve Coil LF Circuit Open
C1196	4502	1196	ABS Outlet Valve Coil LF Circuit Short To Battery
C1197	4503	1197	ABS Outlet Valve Coil LF Circuit Short To Ground
C1198	4504	1198	ABS Inlet Valve Coil LF Circuit Failure
C1199	4505	1199	ABS Inlet Valve Coil LF Circuit Open
C1200	4608	1200	ABS Inlet Valve Coil LF Circuit Short To Battery
C1201	4609	1201	ABS Inlet Valve Coil LF Circuit Short To Ground
C1202	4610	1202	ABS Outlet Valve Coil Rear Circuit Failure
C1203	4611	1203	ABS Outlet Valve Coil Rear Circuit Open
C1204	4612	1204	ABS Outlet Valve Coil Rear Circuit Short To Battery
C1205	4613	1205	ABS Outlet Valve Coil Rear Circuit Short To Ground
C1206	4614	1206	ABS Inlet Valve Coil Rear Circuit Failure

C1207	4615	1207	ABS Inlet Valve Coil Rear Circuit Open	C1258	4696	1258	Speed Wheel LF Comparison Failure
C1208	4616	1208	ABS Inlet Valve Coil Rear Circuit Short To Battery	C1259	4697	1259	Speed Wheel RF Comparison Failure
C1209	4617	1209	ABS Inlet Valve Coil Rear Circuit Short To Ground	C1260	4704	1260	Speed Wheel RR Comparison Failure
C1210	4624	1210	ABS Outlet Valve Coil RF Circuit Failure	C1261	4705	1261	Speed Wheel LR Comparison Failure
C1211	4625	1211	ABS Outlet Valve Coil RF Circuit Open	C1262	4706	1262	Lamp Warning Relay Circuit Failure
C1212	4626	1212	ABS Outlet Valve Coil RF Circuit Short To Battery	C1263	4707	1263	Lamp Warning Relay Circuit Open
C1213	4627	1213	ABS Outlet Valve Coil RF Circuit Short To Ground	C1264	4708	1264	Lamp Warning Relay Circuit Short To Battery
C1214	4628	1214	ABS Inlet Valve Coil RF Circuit Failure	C1265	4709	1265	Lamp Warning Relay Circuit Short To Ground
C1215	4629	1215	ABS Inlet Valve Coil RF Circuit Open	C1266	4710	1266	ABS Valve Power Relay Circuit Failure
C1216	4630	1216	ABS Inlet Valve Coil RF Circuit Short To Battery	C1267	4711	1267	ABS Functions Temporarily Disabled
C1217	4631	1217	ABS Inlet Valve Coil RF Circuit Short To Ground	C1268	4712	1268	Motor Relay # 1 Circuit Failure
C1218	4632	1218	Lamp ABS Warning Output Circuit Failure	C1269	4713	1269	Motor Relay # 1 Circuit Short to Battery
C1219	4633	1219	Lamp ABS Warning Output Circuit Open	C1270	4720	1270	Motor # 1 Input Circuit Failure
C1220	4640	1220	Lamp ABS Warning Output Circuit Short To Battery	C1271	4721	1271	Motor # 1 Input Circuit Short to Gnd
C1221	4641	1221	Lamp ABS Warning Output Circuit Short To Ground	C1272	4722	1272	Motor # 2 Input Circuit Failure
C1222	4642	1222	Speed Wheel Mismatch	C1273	4723	1273	Motor # 2 Input Circuit Short to Vbat
C1223	4643	1223	Lamp Brake Warning Output Circuit Failure	C1274	4724	1274	Solenoid Relay # 1 Circuit Failure
C1224	4644	1224	Lamp Brake Warning Output Circuit Open	C1275	4725	1275	Solenoid Relay # 1 Circuit Short to Vbatt
C1225	4645	1225	Lamp Brake Warning Output Circuit Short To Battery	C1276	4726	1276	Park Brake Actuator Assembly Switch Applied Circuit Short to Gnd
C1226	4646	1226	Lamp Brake Warning Output Circuit Short To Ground	C1277	4727	1277	STEERING Wheel Angle 1and 2 Circuit Failure
C1227	4647	1227	Speed Wheel Sensor LR Input Short Circuit To Battery	C1278	4728	1278	STEERING Wheel Angle 1and 2 Signal Faulted
C1228	4648	1228	Speed Wheel Sensor LR Input Short Circuit To Ground	C1279	4729	1279	Yaw Rate Sensor circuit Failure
C1229	4649	1229	Speed Wheel Sensor Rear Center Coherency Fault	C1280	4736	1280	Yaw Rate Sensor Signal Fault
C1230	4656	1230	Speed Wheel Sensor Rear Center Input Circuit Failure	C1281	4737	1281	Lateral Accelerometer circuit Failure
C1231	4657	1231	Speed Wheel Sensor Rear Center Circuit Open	C1282	4738	1282	Lateral Accelerometer Signal Fault
C1232	4658	1232	Speed Wheel Sensor Rear Center Input Short Circuit To Battery	C1283	4739	1283	Switch Test Signal Failure
C1233	4659	1233	Speed Wheel LF Input Signal Missing	C1284	4740	1284	Oil Pressure Switch Failure
C1234	4660	1234	Speed Wheel RF Input Signal Missing	C1285	4741	1285	Booster Solenoid circuit Failure
C1235	4661	1235	Speed Wheel RR Input Signal Missing	C1286	4742	1286	Booster Mechanical Failure
C1236	4662	1236	Speed Wheel LR Input Signal Missing	C1287	4743	1287	Booster Pedal Force switch circuit Failure
C1237	4663	1237	Speed Wheel Rear Input Signal Missing	C1288	4744	1288	Pressure Transducer Main / Primary Input Circuit Failure
C1238	4664	1238	ABS Hydraulic Pressure Differential Switch Input Circuit Failure	C1289	4745	1289	Pressure Transducer Redundant / Secondary Input Circuit Failure
C1239	4665	1239	ABS Hydraulic Pressure Differential Switch Input Open Circuit	C1400	5120	1400	Traction Control Valve RF Circuit Failure
C1240	4672	1240	ABS Hydraulic Pressure Differential Switch Input Short Circuit To Battery	C1401	5121	1401	Traction Control Valve RF Circuit Open
C1241	4673	1241	ABS Hydraulic Pressure Differential Switch Input Short Circuit To Ground	C1402	5122	1402	Traction Control Valve RF Circuit Short To Ground
C1242	4674	1242	ABS Outlet Valve Coil LR Circuit Failure	C1403	5123	1403	Traction Control Valve RF Circuit Short To Battery
C1243	4675	1243	ABS Outlet Valve Coil LR Circuit Open	C1404	5124	1404	Traction Control Valve Rear Circuit Failure
C1244	4676	1244	ABS Outlet Valve Coil LR Circuit Short To Battery	C1405	5125	1405	Traction Control Valve Rear Circuit Open
C1245	4677	1245	ABS Outlet Valve Coil LR Circuit Short To Ground	C1406	5126	1406	Traction Control Valve Rear Circuit Short To Ground
C1246	4678	1246	ABS Outlet Valve Coil RR Circuit Failure	C1407	5127	1407	Traction Control Valve Rear Circuit Short To Battery
C1247	4679	1247	ABS Outlet Valve Coil RR Circuit Open	C1410	5136	1410	Traction Control Valve LF Circuit Failure
C1248	4680	1248	ABS Outlet Valve Coil RR Circuit Short To Battery	C1411	5137	1411	Traction Control Valve LF Circuit Open
C1249	4681	1249	ABS Outlet Valve Coil RR Circuit Short To Ground	C1412	5138	1412	Traction Control Valve LF Circuit Short To Ground
C1250	4688	1250	ABS Inlet Valve Coil LR Circuit Failure	C1413	5139	1413	Traction Control Valve LF Circuit Short To Battery
C1251	4689	1251	ABS Inlet Valve Coil LR Circuit Open	C1414	5140	1414	Incorrect Module Design Level
C1252	4690	1252	ABS Inlet Valve Coil LR Circuit Short To Battery	C1415	5141	1415	Incorrect Module Configuration
C1253	4691	1253	ABS Inlet Valve Coil LR Circuit Short To Ground	C1416	5142	1416	Damper RF Circuit Short To Battery
C1254	4692	1254	ABS Inlet Valve Coil RR Circuit Failure	C1417	5143	1417	Damper RF Circuit Short to Ground
C1255	4693	1255	ABS Inlet Valve Coil RR Circuit Open	C1418	5144	1418	Damper RF Circuit Failure
C1256	4694	1256	ABS Inlet Valve Coil RR Circuit Short To Battery	C1419	5145	1419	Damper RF Circuit Open
C1257	4695	1257	ABS Inlet Valve Coil RR Circuit Short To Ground	C1420	5152	1420	Hydraulic Fluid Pressure/ Flow Circuit Short to Vbatt

C1421	5153	1421	Damper LF Circuit Short To Battery	C1498	5272	1498	Traction Control Motor Potentiometer Circuit Short to Ground
C1422	5154	1422	Damper LF Circuit Short to Ground	C1499	5273	1499	Transfer Case Contact Plate "A" Encoder Circuit Failure
C1423	5155	1423	Damper LF Circuit Failure	C1500	5376	1500	Transfer Case Contact Plate "B" Encoder Circuit Failure
C1424	5156	1424	Damper LF Circuit Open	C1501	5377	1501	Transfer Case Contact Plate "C" Encoder Circuit Failure
C1425	5157	1425	Damper RR Circuit Short to Ground	C1502	5378	1502	Transfer Case Contact Plate "D" Encoder Circuit Failure
C1426	5158	1426	Damper RR Circuit Short To Battery	C1503	5379	1503	Dynamic Stability Control Left Front Valve Malfunction
C1427	5159	1427	Damper RR Circuit Open	C1504	5380	1504	Dynamic Stability Control Right Front Valve Malfunction
C1428	5160	1428	Damper RR Circuit Failure	C1505	5381	1505	Dynamic Stability Control Left Rear Valve Malfunction
C1429	5161	1429	Input-shaft-speed input circuit failure	C1506	5382	1506	Dynamic Stability Control Right Rear Valve Malfunction
C1430	5168	1430	Damper LR Circuit Open	C1507	5383	1507	Traction Control of Brake Exceeds Time-Out
C1431	5169	1431	Damper LR Circuit Short To Battery	C1508	5384	1508	Traction Control of Engine Exceeds Time-Out
C1432	5170	1432	Damper LR Circuit Short to Ground	C1510	5392	1510	Right Front Wheel Pressure Reduction Performance Problem
C1433	5171	1433	Damper LR Circuit Failure	C1511	5393	1511	Left Front Wheel Pressure Reduction Performance Problem
C1435	5173	1435	Accelerometer Rear Circuit Failure	C1512	5394	1512	Right Rear Wheel Pressure Reduction Performance Problem
C1436	5174	1436	Accelerometer Rear Circuit Signal Is Not Sensed	C1513	5395	1513	Left rear Wheel Pressure Reduction Performance Problem
C1437	5175	1437	Accelerometer Rear Circuit Short To Ground	C1699	5785	1699	Left Rear Sensor Circuit Short to Vbat
C1438	5176	1438	Accelerometer Rear Circuit Short To Battery	C1700	5888	1700	Left Rear Sensor Circuit Failure
C1439	5177	1439	Vehicle Acceleration EEC-IV Circuit Failure	C1701	5889	1701	Left Rear Sensor Circuit Fault
C1440	5184	1440	Pressure Transducer Main / Primary signal Faulted	C1702	5890	1702	RightRear Sensor Circuit Short to Vbat
C1441	5185	1441	Steering Phase A Circuit Signal Is Not Sensed	C1703	5891	1703	Right Rear Sensor Circuit Failure
C1442	5186	1442	Steering Phase B Circuit Signal Is Not Sensed	C1704	5892	1704	Right Rear Sensor Circuit Fault
C1443	5187	1443	Steering Phase A Circuit Short To Ground	C1705	5893	1705	Left Rear Center Sensor Circuit Short to Vbat
C1444	5188	1444	Steering Phase B Circuit Short To Ground	C1706	5894	1706	Left Rear Center Sensor Circuit Failure
C1445	5189	1445	Speed Vehicle Signal Circuit Failure	C1707	5895	1707	Left Rear Center Sensor Circuit Fault
C1446	5190	1446	Brake Switch Circuit Failure	C1708	5896	1708	Right Rear Center Sensor Circuit Short to Vbat
C1447	5191	1447	Traction Control Module Request Circuit Failure	C1709	5897	1709	Right Rear Center Sensor Circuit Failure
C1448	5192	1448	Lamp Adaptive Damping Warning Circuit Failure	C1710	5904	1710	Right Rear Center Sensor Circuit Fault
C1449	5193	1449	Traction Control Motor Coherency Fault	C1711	5905	1711	Left Front Sensor Circuit Short to Vbat
C1450	5200	1450	Traction Control Motor Circuit Failure	C1712	5906	1712	Left Front Sensor Circuit Failure
C1451	5201	1451	Traction Control Motor Circuit Open	C1713	5907	1713	Left Front Sensor Circuit Fault
C1452	5202	1452	Traction Control Motor Circuit Short to Battery	C1714	5908	1714	Right Front Sensor Circuit Short to Vbat
C1453	5203	1453	Traction Control Motor Circuit Short to Ground	C1715	5909	1715	Right Front Sensor Circuit Failure
C1454	5204	1454	Front Lateral Accelerometer Circuit Failure	C1716	5910	1716	Right Front Sensor Circuit Fault
C1455	5205	1455	Accelerometer Front Circuit Failure	C1717	5911	1717	Left Front Center Sensor Circuit Short to Vbat
C1456	5206	1456	Accelerometer Front Circuit Is Not Sensed	C1718	5912	1718	Left Front Center Sensor Circuit Failure
C1457	5207	1457	Accelerometer Front Circuit Short To Ground	C1719	5913	1719	Left Front Center Sensor Circuit Fault
C1458	5208	1458	Accelerometer Front Circuit Short To Battery	C1721	5921	1721	Air Suspension Height Sensor Power Circuit Open
C1459	5209	1459	Adaptive Mode Switch Circuit Failure	C1722	5922	1722	Air Suspension Height Sensor Power Circuit Short To Battery
C1460	5216	1460	Vehicle Accelerometer Power Circuit Failure	C1723	5923	1723	Air Suspension Height Sensor Power Circuit Short To Ground
C1461	5217	1461	Vehicle Accelerometer Power Circuit Short to Battery	C1724	5924	1724	Air Suspension Height Sensor Power Circuit Failure
C1462	5218	1462	Left Front Vertical Accelerometer Circuit Failure	C1725	5925	1725	Air Suspension Front Pneumatic Failure
C1463	5219	1463	Right Front Vertical Accelerometer Circuit Failure	C1726	5926	1726	Air Suspension Rear Pneumatic Failure
C1464	5220	1464	Pressure Transducer Redundant / Secondary Signal Faulted	C1727	5927	1727	Air Suspension Reservoir Pneumatic Failure
C1465	5221	1465	Damper High Side Front Circuit Short To Battery	C1728	5928	1728	Transfer Case unable to transition between 2H and 4H
C1466	5222	1466	Damper Circuit Failure	C1729	5929	1729	Transfer Case unable to transition between 4H and 4L
C1467	5223	1467	Damper High Side Rear Circuit Short To Battery	C1730	5936	1730	Reference Voltage Out of Range (+5 v)
C1468	5224	1468	Damper Low Side Front Circuit Failure	C1731	5937	1731	Air Suspension LF Corner Up Timeout
C1469	5225	1469	Damper Low Side Rear Circuit Failure	C1732	5938	1732	Air Suspension LF Corner Down Timeout
C1495	5269	1495	Traction Control Motor Potentiometer Circuit Failure	C1733	5939	1733	Air Suspension RF Corner Up Timeout
C1496	5270	1496	Traction Control Motor Potentiometer Circuit Open	C1734	5940	1734	Air Suspension RF Corner Down Timeout
C1497	5271	1497	Traction Control Motor Potentiometer Circuit Short to Battery	C1735	5941	1735	Air Suspension LR Corner Up Timeout

C1736	5942	1736	Air Suspension LR Corner Down Timeout	C1805	6149	1805	Mismatched PCM and/or ABS-TC Module
C1737	5943	1737	Air Suspension RR Corner Up Timeout	C1813	6163	1813	Air Suspension LR Vent Request Exceeded Max Timing
C1738	5944	1738	Air Suspension RR Corner Down Timeout	C1814	6164	1814	Air Suspension RR Vent Request Exceeded Max Timing
C1739	5945	1739	Right Front Center Sensor Circuit Short to Vbat	C1818	6168	1818	Air Suspension LR Air Compress Request Exceeded Max Timing
C1740	5952	1740	Right Front Center Sensor Circuit Failure	C1819	6169	1819	Air Suspension RR Air Compress Request Exceeded Max Timing
C1741	5953	1741	Right Front Center Sensor Circuit Fault	C1820	6176	1820	Air Suspension RF Air Compress Request Exceeded Max Timing
C1742	5954	1742	Rear Sounder Circuit Failure	C1830	6192	1830	Air Suspension Compressor Relay Circuit Failure
C1743	5955	1743	Rear Sounder Circuit Short to Vbatt	C1831	6193	1831	Air Suspension Compressor Relay Circuit Open
C1744	5956	1744	Front Sounder Circuit Failure	C1832	6194	1832	Air Suspension Compressor Relay Circuit Short To Battery
C1745	5957	1745	Front Sounder Circuit Short to Vbatt	C1833	6195	1833	Air Suspension Compressor Relay Circuit Short To Ground
C1748	5960	1748	Switch input Circuit Short to Gnd	C1834	6196	1834	Gauge Drive Current Fault
C1749	5961	1749	Trailer Input Circuit Failure	C1835	6197	1835	Current Sense Circuit Failure
C1750	5968	1750	Accelerator Position Sensor Out of Range	C1836	6198	1836	Battery Temp out of Range
C1751	5969	1751	Vehicle Speed Sensor # 1 Output Circuit Short to Vbatt	C1837	6199	1837	Battery Heater Circuit Failure
C1752	5970	1752	Vehicle Speed Sensor # 1 Output Circuit Short to Gnd	C1838	6200	1838	Charging System Fault
C1753	5971	1753	Hydraulic Clutch Actuator Valve Signal Fault	C1839	6201	1839	Leakage Fault
C1754	5972	1754	Hydraulic Clutch Actuator Valve Circuit Failure	C1840	6208	1840	Air Suspension Disable Switch Circuit Failure
C1755	5973	1755	Power Limit Shutdown Fault	C1841	6209	1841	Air Suspension Disable Switch Circuit Open
C1756	5974	1756	Air Suspension Front Height Sensor High (SE) Signal Circuit Failure	C1842	6210	1842	Air Suspension Disable Switch Circuit Short To Battery
C1757	5975	1757	Air Suspension Front Height Sensor High (SE) Signal Circuit Open	C1843	6211	1843	Air Suspension Disable Switch Circuit Short To Ground
C1758	5976	1758	Air Suspension Front Height Sensor High (SE) Signal Circuit Short To Battery	C1844	6212	1844	Air Suspension Secondary Front Inflator Solenoid Output Circuit Failure
C1759	5977	1759	Air Suspension Front Height Sensor High (SE) Signal Circuit Short To Ground	C1845	6213	1845	Air Suspension Front Inflator Solenoid Output Circuit Failure
C1760	5984	1760	Air Suspension Rear Height Sensor High (SE) Signal Circuit Failure	C1846	6214	1846	Air Suspension Front Inflator Solenoid Output Circuit Open
C1761	5985	1761	Air Suspension Rear Height Sensor High (SE) Signal Circuit Open	C1847	6215	1847	Air Suspension Front Inflator Solenoid Output Circuit Short To Battery
C1762	5986	1762	Air Suspension Rear Height Sensor High (SE) Signal Circuit Short To Battery	C1848	6216	1848	Air Suspension Front Inflator Solenoid Output Circuit Short To Ground
C1763	5987	1763	Air Suspension Rear Height Sensor High (SE) Signal Circuit Short To Ground	C1849	6217	1849	Master Cylinder Pressure Out of Range
C1765	5989	1765	Air Suspension Rear Height Sensor Low Signal Circuit Failure	C1850	6224	1850	Air Suspension Warning Lamp Circuit Failure
C1766	5990	1766	Air Suspension Rear Height Sensor Low Signal Circuit Open	C1851	6225	1851	Air Suspension Warning Lamp Circuit Open
C1767	5991	1767	Air Suspension Rear Height Sensor Low Signal Circuit Short To Battery	C1852	6226	1852	Air Suspension Warning Lamp Circuit Short To Battery
C1768	5992	1768	Air Suspension Rear Height Sensor Low Signal Circuit Short To Ground	C1853	6227	1853	Air Suspension Warning Lamp Circuit Short To Ground
C1770	6000	1770	Air Suspension Vent Solenoid Output Circuit Failure	C1854	6228	1854	Motor Temperature Out of Range
C1771	6001	1771	Air Suspension Vent Solenoid Output Circuit Open	C1855	6229	1855	Acceleration Position Sensor Conflict
C1772	6002	1772	Air Suspension Vent Solenoid Output Circuit Short To Battery	C1856	6230	1856	Traction Motor Encoder circuit Failure
C1773	6003	1773	Air Suspension Vent Solenoid Output Circuit Short To Ground	C1859	6233	1859	PRNDL Input #2 Circuit Failure
C1774	6004	1774	Coolant Temp Out of Range	C1860	6240	1860	PRNDL Input #3 Circuit Failure
C1775	6005	1775	DC-DC Converter Failure	C1861	6241	1861	PRNDL Input #4 Circuit Failure
C1776	6006	1776	Heater System Failure	C1862	6242	1862	Contacto Circuit Failure
C1777	6007	1777	Vacuum Pressure Circuit Failure	C1863	6243	1863	External Charging Fault
C1778	6008	1778	Power Steering Failure	C1864	6244	1864	Battery Module Fault
C1779	6009	1779	Blower Switch Failure	C1865	6245	1865	Air Suspension Rear Inflator Solenoid Output Circuit Failure
C1780	6016	1780	Temperature Select Failure	C1866	6246	1866	Air Suspension Rear Inflator Solenoid Output Circuit Open
C1781	6017	1781	Engine Coolant Temperature Signal Missing/Fault	C1867	6247	1867	Air Suspension Rear Inflator Solenoid Output Circuit Short To Battery
C1790	6032	1790	Air Suspension LR Air Spring/Shock Solenoid Output Circuit Failure	C1868	6248	1868	Air Suspension Rear Inflator Solenoid Output Circuit Short To Ground
C1791	6033	1791	Air Suspension LR Air Spring/Shock Solenoid Output Circuit Open	C1869	6249	1869	Air Suspension Gate Solenoid Output Circuit Failure
C1792	6034	1792	Air Suspension LR Air Spring/Shock Solenoid Output Circuit Short To Battery	C1870	6256	1870	Air Suspension Gate Solenoid Output Circuit Open
C1793	6035	1793	Air Suspension LR Air Spring/Shock Solenoid Output Circuit Short To Ground	C1871	6257	1871	Air Suspension Gate Solenoid Output Circuit Short To Battery
C1795	6037	1795	Air Suspension RR Air Spring/Shock Solenoid Output Circuit Failure	C1872	6258	1872	Air Suspension Gate Solenoid Output Circuit Short To Ground
C1796	6038	1796	Air Suspension RR Air Spring/Shock Solenoid Output Circuit Open	C1873	6259	1873	Air Suspension RF Air Spring Solenoid Output Circuit Failure
C1797	6039	1797	Air Suspension RR Air Spring/Shock Solenoid Output Circuit Short To Battery	C1874	6260	1874	Air Suspension RF Air Spring Solenoid Output Circuit Open
C1798	6040	1798	Air Suspension RR Air Spring/Shock Solenoid Output Circuit Short To Ground	C1875	6261	1875	Air Suspension RF Air Spring Solenoid Output Circuit Short To Battery
C1800	6144	1800	Air Suspension Reservoir Solenoid Circuit Failure	C1876	6262	1876	Air Suspension RF Air Spring Solenoid Output Circuit Short To Ground

C1877	6263	1877	Air Suspension LF Air Spring Solenoid Output Circuit Failure	C1929	6441	1929	Air Suspension Front Compressor Relay Circuit Failure
C1878	6264	1878	Air Suspension LF Air Spring Solenoid Output Circuit Open	C1930	6448	1930	Air Suspension Front Compressor Relay Circuit Open
C1879	6265	1879	Air Suspension LF Air Spring Solenoid Output Circuit Short To Battery	C1931	6449	1931	Air Suspension Front Compressor Relay Circuit Short To Battery
C1880	6272	1880	Air Suspension LF Air Spring Solenoid Output Circuit Short To Ground	C1932	6450	1932	Air Suspension Front Compressor Relay Circuit Short To Ground
C1881	6273	1881	Air Suspension RF Height Sensor Circuit Failure	C1933	6451	1933	Solenoid Current Out Of Range
C1882	6274	1882	Air Suspension RF Height Sensor Circuit Open	C1934	6452	1934	HPU (Hydraulic Pump Unit) Pressurisation Failure
C1883	6275	1883	Air Suspension RF Height Sensor Circuit Short To Battery	C1935	6453	1935	Chime Circuit Failure
C1884	6276	1884	Air Suspension RF Height Sensor Circuit Short To Ground	C1936	6454	1936	Hydraulic Pump Relay Circuit Failure
C1885	6277	1885	Air Suspension RR Height Sensor Circuit Failure	C1937	6455	1937	Steering Wheel Angle Sensor Offset Failure
C1886	6278	1886	Air Suspension RR Height Sensor Circuit Open	C1938	6456	1938	Invalid Steering Wheel Angle Sensor ID
C1887	6279	1887	Air Suspension RR Height Sensor Circuit Short To Battery	C1939	6457	1939	Brake Pressure Switch Input Circuit Failure
C1888	6280	1888	Air Suspension RR Height Sensor Circuit Short To Ground	C1940	6464	1940	Brake Pressure Switch Mechanical Failure
C1889	6281	1889	Air Suspension LF Height Sensor Circuit Failure	C1942	6466	1942	Unrecognized Powertrain Configuration
C1890	6288	1890	Air Suspension LF Height Sensor Circuit Open	C1943	6467	1943	Airbag Deployment Indication Input Fault
C1891	6289	1891	Air Suspension LF Height Sensor Circuit Short To Battery	C1944	6468	1944	Gauge Driver Circuit Fault
C1892	6290	1892	Air Suspension LF Height Sensor Circuit Short To Ground	C1945	6469	1945	Park Switch Indicates Park with Vehicle Moving
C1893	6291	1893	Air Suspension LR Height Sensor Circuit Failure	C1946	6470	1946	Seat Track Position Switch Circuit Open
C1894	6292	1894	Air Suspension LR Height Sensor Circuit Open	C1947	6471	1947	Seat Track Position Switch Circuit Short to Ground
C1895	6293	1895	Air Suspension LR Height Sensor Circuit Short To Battery	C1948	6472	1948	Seat Track Position Switch Circuit Resistance Out of Range
C1896	6294	1896	Air Suspension LR Height Sensor Circuit Short To Ground	C1949	6473	1949	Accelerometer Sensor Circuit Open
C1897	6295	1897	Steering VAPS II Circuit Loop Failure	C1950	6480	1950	Accelerometer Sensor Circuit Failure
C1898	6296	1898	Steering VAPS II Circuit Loop Open	C1951	6481	1951	Lateral Accelerometer Sensor Circuit Open
C1899	6297	1899	Steering VAPS II Circuit Loop Short To Battery	C1952	6482	1952	Yaw Rate Sensor Circuit Open
C1900	6400	1900	Steering VAPS II Circuit Loop Short To Ground	C1953	6483	1953	Master Cylinder Pressure Sensor Circuit Open
C1901	6401	1901	Ride Control RR Shock Actuator Circuit Failure	C1954	6484	1954	Master Cylinder Pressure Sensor Circuit Failure
C1902	6402	1902	Ride Control RR Shock Actuator Circuit Open	C1955	6485	1955	Steering Angle Sensor Circuit Open
C1903	6403	1903	Ride Control RR Shock Actuator Circuit Short To Battery	C1956	6486	1956	Steering Angle Sensor Circuit Failure
C1904	6404	1904	Ride Control RR Shock Actuator Circuit Short To Ground	C1957	6487	1957	Dynamic Stability Control Valve RF Circuit Failure
C1905	6405	1905	Ride Control LR Shock Actuator Circuit Failure	C1958	6488	1958	Dynamic Stability Control Valve LF Circuit Failure
C1906	6406	1906	Ride Control LR Shock Actuator Circuit Open	C1959	6489	1959	Lateral Accelerometer Sensor Circuit Failure
C1907	6407	1907	Ride Control LR Shock Actuator Circuit Short To Battery	C1960	6496	1960	Driver Brake Apply Circuit Fault
C1908	6408	1908	Ride Control LR Shock Actuator Circuit Short To Ground	C1961	6497	1961	Park Lamp Relay Coil Circuit Failure
C1909	6409	1909	Ride Control RF Shock Actuator Circuit Failure	C1962	6498	1962	Park Lamp Relay Coil Short to Battery
C1910	6416	1910	Ride Control RF Shock Actuator Circuit Open	C1963	6499	1963	Stability Control Inhibit Warning
C1911	6417	1911	Ride Control RF Shock Actuator Circuit Short To Battery	C2767	10087	2767	Reserved – TBD
C1912	6418	1912	Ride Control RF Shock Actuator Circuit Short To Ground				
C1913	6419	1913	Ride Control LF Shock Actuator Circuit Failure				
C1914	6420	1914	Ride Control LF Shock Actuator Circuit Open				
C1915	6421	1915	Ride Control LF Shock Actuator Circuit Short To Battery				
C1916	6422	1916	Ride Control LF Shock Actuator Circuit Short To Ground				
C1917	6423	1917	Steering EVO Out-of-Range Fault				
C1918	6424	1918	Air Suspension Ride Height Select Switch Circuit Failure				
C1920	6432	1920	Led #1 Circuit Failure				
C1921	6433	1921	VAPS Solenoid Actuator Output Circuit Failure				
C1922	6434	1922	VAPS Solenoid Actuator Output Circuit Open				
C1923	6435	1923	VAPS Solenoid Actuator Output Circuit Short To Battery				
C1924	6436	1924	VAPS Solenoid Actuator Output Circuit Short To Ground				
C1925	6437	1925	VAPS Solenoid Actuator Return Circuit Failure				
C1926	6438	1926	VAPS Solenoid Actuator Return Circuit Open				
C1927	6439	1927	VAPS Solenoid Actuator Return Circuit Short To Battery				
C1928	6440	1928	VAPS Solenoid Actuator Return Circuit Short To Ground				



**Códigos U:** En este caso hay códigos exigido por norma y otros que el fabricante los realiza.

Código OBD	Código Avería	Código HEX	Interpretación de la Avería
U0001	1	0001	High Speed CAN Communication Bus
U0002	2	0002	High Speed CAN Communication Bus Performance
U0003	3	0003	High Speed CAN Communication Bus (+) Open
U0004	4	0004	High Speed CAN Communication Bus (+) Low
U0005	5	0005	High Speed CAN Communication Bus (+) High
U0006	6	0006	High Speed CAN Communication Bus (-) Open
U0007	7	0007	High Speed CAN Communication Bus (-) Low
U0008	8	0008	High Speed CAN Communication Bus (-) High
U0009	9	0009	High Speed CAN Communication Bus (-) shorted to Bus (+)
U0010	16	0010	Medium Speed CAN Communication Bus
U0011	17	0011	Medium Speed CAN Communication Bus Performance
U0012	18	0012	Medium Speed CAN Communication Bus (+) Open
U0013	19	0013	Medium Speed CAN Communication Bus (+) Low
U0014	20	0014	Medium Speed CAN Communication Bus (+) High
U0015	21	0015	Medium Speed CAN Communication Bus (-) Open
U0016	22	0016	Medium Speed CAN Communication Bus (-) Low
U0017	23	0017	Medium Speed CAN Communication Bus (-) High
U0018	24	0018	Medium Speed CAN Communication Bus (-) shorted to Bus (+)
U0019	25	0019	Low Speed CAN Communication Bus
U0020	32	0020	Low Speed CAN Communication Bus Performance
U0021	33	0021	Low Speed CAN Communication Bus (+) Open
U0022	34	0022	Low Speed CAN Communication Bus (+) Low
U0023	35	0023	Low Speed CAN Communication Bus (+) High
U0024	36	0024	Low Speed CAN Communication Bus (-) Open
U0025	37	0025	Low Speed CAN Communication Bus (-) Low
U0026	38	0026	Low Speed CAN Communication Bus (-) High
U0027	39	0027	Low Speed CAN Communication Bus (-) shorted to Bus (+)
U0028	40	0028	Vehicle Communication Bus A
U0029	41	0029	Vehicle Communication Bus A Performance
U0030	48	0030	Vehicle Communication Bus A (+) Open
U0031	49	0031	Vehicle Communication Bus A (+) Low
U0032	50	0032	Vehicle Communication Bus A (+) High
U0033	51	0033	Vehicle Communication Bus A (-) Open
U0034	52	0034	Vehicle Communication Bus A (-) Low
U0035	53	0035	Vehicle Communication Bus A (-) High
U0036	54	0036	Vehicle Communication Bus A (-) shorted to Bus A (+)
U0037	55	0037	Vehicle Communication Bus B
U0038	56	0038	Vehicle Communication Bus B Performance
U0039	57	0039	Vehicle Communication Bus B (+) Open
U0040	64	0040	Vehicle Communication Bus B (+) Low
U0041	65	0041	Vehicle Communication Bus B (+) High
U0042	66	0042	Vehicle Communication Bus B (-) Open
U0043	67	0043	Vehicle Communication Bus B (-) Low
U0044	68	0044	Vehicle Communication Bus B (-) High
U0045	69	0045	Vehicle Communication Bus B (-) shorted to Bus B (+)
U0046	70	0046	Vehicle Communication Bus C
U0047	71	0047	Vehicle Communication Bus C Performance
U0048	72	0048	Vehicle Communication Bus C (+) Open
U0049	73	0049	Vehicle Communication Bus C (+) Low
U0050	80	0050	Vehicle Communication Bus C (+) High
U0051	81	0051	Vehicle Communication Bus C (-) Open
U0052	82	0052	Vehicle Communication Bus C (-) Low
U0053	83	0053	Vehicle Communication Bus C (-) High
U0054	84	0054	Vehicle Communication Bus C (-) shorted to Bus C (+)
U0055	85	0055	Vehicle Communication Bus D
U0056	86	0056	Vehicle Communication Bus D Performance
U0057	87	0057	Vehicle Communication Bus D (+) Open
U0058	88	0058	Vehicle Communication Bus D (+) Low
U0059	89	0059	Vehicle Communication Bus D (+) High
U0060	96	0060	Vehicle Communication Bus D (-) Open
U0061	97	0061	Vehicle Communication Bus D (-) Low
U0062	98	0062	Vehicle Communication Bus D (-) High
U0063	99	0063	Vehicle Communication Bus D (-) shorted to Bus D (+)
U0064	100	0064	Vehicle Communication Bus E
U0065	101	0065	Vehicle Communication Bus E Performance
U0066	102	0066	Vehicle Communication Bus E (+) Open
U0067	103	0067	Vehicle Communication Bus E (+) Low
U0068	104	0068	Vehicle Communication Bus E (+) High
U0069	105	0069	Vehicle Communication Bus E (-) Open
U0070	112	0070	Vehicle Communication Bus E (-) Low
U0071	113	0071	Vehicle Communication Bus E (-) High
U0072	114	0072	Vehicle Communication Bus E (-) shorted to Bus E (+)
U0073	115	0073	Control Module Communication Bus Off
U0100	256	0100	Lost Communication with ECM/PCM "A"
U0101	257	0101	Lost Communication with TCM
U0102	258	0102	Lost Communication with Transfer Case Control Module
U0103	259	0103	Lost Communication with Gear Shift Module
U0104	260	0104	Lost Communication with Cruise Control Module
U0105	261	0105	Lost Communication with Fuel Injector Control Module
U0106	262	0106	Lost Communication with Glow Plug Control Module
U0107	263	0107	Lost Communication with Throttle Actuator Control Module
U0108	264	0108	Lost Communication with Alternative Fuel Control Module
U0109	265	0109	Lost Communication with Fuel Pump Control Module
U0110	272	0110	Lost Communication with Drive Motor Control Module
U0111	273	0111	Lost Communication With Battery Energy Control Module "A"
U0112	274	0112	Lost Communication With Battery Energy Control Module "B"
U0113	275	0113	Lost Communication With Emissions Critical Control Information
U0114	276	0114	Lost Communication With Four-Wheel Drive Clutch Control Module
U0115	277	0115	Lost Communication With ECM/PCM "B"
U0121	289	0121	Lost Communication With Anti-Lock Brake System (ABS) Control Module
U0122	290	0122	Lost Communication With Vehicle Dynamics Control Module
U0123	291	0123	Lost Communication With Yaw Rate Sensor Module
U0124	292	0124	Lost Communication With Lateral Acceleration Sensor Module
U0125	293	0125	Lost Communication With Multi-axis Acceleration Sensor Module
U0126	294	0126	Lost Communication With Steering Angle Sensor Module
U0127	295	0127	Lost Communication With Tire Pressure Monitor Module

U0128	296	0128	Lost Communication With Park Brake Control Module	U0186	390	0186	Lost Communication With Audio Amplifier
U0129	297	0129	Lost Communication With Brake System Control Module	U0187	391	0187	Lost Communication With Digital Disc Player/Changer Module "A"
U0130	304	0130	Lost Communication With Steering Effort Control Module	U0188	392	0188	Lost Communication With Digital Disc Player/Changer Module "B"
U0131	305	0131	Lost Communication With Power Steering Control Module	U0189	393	0189	Lost Communication With Digital Disc Player/Changer Module "C"
U0132	306	0132	Lost Communication With R ide Level Control Module	U0190	400	0190	Lost Communication with Digital Disc Player/Changer Module "D"
U0140	320	0140	Lost Communication With Body Control Module	U0191	401	0191	Lost Communication With Television
U0141	321	0141	Lost Communication With Body Control Module "A "	U0192	402	0192	Lost Communication With Personal Computer
U0142	322	0142	Lost Communication With Body Control Module "B "	U0193	403	0193	Lost Communication With "Digital Audio Control Module A"
U0143	323	0143	Lost Communication With Body Control Module "C"	U0194	404	0194	Lost Communication With "Digital Audio Control Module B"
U0144	324	0144	Lost Communication With Body Control Module "D"	U0195	405	0195	Lost Communication With Subscription Entertainment Receiver Module
U0145	325	0145	Lost Communication With Body Control Module "E "	U0196	406	0196	Lost Communication With Rear Seat Entertainment Control Module
U0146	326	0146	Lost Communication With Gateway "A"	U0197	407	0197	Lost Communication With Telephone Control Module
U0147	327	0147	Lost Communication With Gateway "B"	U0198	408	0198	Lost Communication With Telematic Control Module
U0148	328	0148	Lost Communication With Gateway "C"	U0199	409	0199	Lost Communication With "Door Control Module A"
U0149	329	0149	Lost Communication With Gateway "D"	U0200	512	0200	Lost Communication With "Door Control Module B"
U0150	336	0150	Lost Communication With Gateway "E"	U0201	513	0201	Lost Communication With "Door Control Module C"
U0151	337	0151	Lost Communication With Restraints Control Module	U0202	514	0202	Lost Communication With "Door Control Module D"
U0152	338	0152	Lost Communication With Side Restraints Control Module (Left)	U0203	515	0203	Lost Communication With "Door Control Module E"
U0153	339	0153	Lost Communication With Side Restraints Control Module (Right)	U0204	516	0204	Lost Communication With "Door Control Module F"
U0154	340	0154	Lost Communication With Restraints Occupant Sensing Control Module	U0205	517	0205	Lost Communication With "Door Control Module G"
U0155	341	0155	Lost Communication With Instrument Panel Cluster (IPC) Control Module	U0206	518	0206	Lost Communication With Folding Top Control Module
U0156	342	0156	Lost Communication With Information Center "A"	U0207	519	0207	Lost Communication With Moveable Roof Control Module
U0157	343	0157	Lost Communication With Information Center "B"	U0208	520	0208	Lost Communication With "Seat Control Module A"
U0158	344	0158	Lost Communication With Head Up Display	U0209	521	0209	Lost Communication With "Seat Control Module B"
U0159	345	0159	Lost Communication With Parking Assist Control Module	U0210	528	0210	Lost Communication With "Seat Control Module C"
U0160	352	0160	Lost Communication With Audible Alert Control Module	U0211	529	0211	Lost Communication With "Seat Control Module D"
U0161	353	0161	Lost Communication With Compass Module	U0212	530	0212	Lost Communication With Steering Column Control Module
U0162	354	0162	Lost Communication With Navigation Display Module	U0213	531	0213	Lost Communication With Mirror Control Module
U0163	355	0163	Lost Communication With Navigation Control Module	U0214	532	0214	Lost Communication With Remote Function Actuation
U0164	356	0164	Lost Communication With HVAC Control Module	U0215	533	0215	Lost Communication With "Door Switch A"
U0165	357	0165	Lost Communication With HVAC Control Module (Rear)	U0216	534	0216	Lost Communication With "Door Switch B"
U0166	358	0166	Lost Communication With Auxiliary Heater Control Module	U0217	535	0217	Lost Communication With "Door Switch C "
U0167	359	0167	Lost Communication With Vehicle Immobilizer Control Module	U0218	536	0218	Lost Communication With "Door Switch D "
U0168	360	0168	Lost Communication With Vehicle Security Control Module	U0219	537	0219	Lost Communication With "Door Switch E"
U0169	361	0169	Lost Communication With Sunroof Control Module	U0220	544	0220	Lost Communication With "Door Switch F"
U0170	368	0170	Lost Communication With "Restraints System Sensor A"	U0221	545	0221	Lost Communication With "Door Switch G "
U0171	369	0171	Lost Communication With "Restraints System Sensor B"	U0222	546	0222	Lost Communication With "Door Window Motor A"
U0172	370	0172	Lost Communication With "Restraints System Sensor C"	U0223	547	0223	Lost Communication With "Door Window Motor B"
U0173	371	0173	Lost Communication With "Restraints System Sensor D"	U0224	548	0224	Lost Communication With "Door Window Motor C"
U0174	372	0174	Lost Communication With "Restraints System Sensor E"	U0225	549	0225	Lost Communication With "Door Window Motor D"
U0175	373	0175	Lost Communication With "Restraints System Sensor F"	U0226	550	0226	Lost Communication With "Door Window Motor E"
U0176	374	0176	Lost Communication With "Restraints System Sensor G"	U0227	551	0227	Lost Communication With "Door Window Motor F"
U0177	375	0177	Lost Communication With "Restraints System Sensor H"	U0228	552	0228	Lost Communication With "Door Window Motor G"
U0178	376	0178	Lost Communication With "Restraints System Sensor I"	U0229	553	0229	Lost Communication With Heated Steering Wheel Module
U0179	377	0179	Lost Communication With "Restraints System Sensor J"	U0230	560	0230	Lost Communication With Rear Gate Module
U0180	384	0180	Lost Communication With Automatic Lighting Control Module	U0231	561	0231	Lost Communication With Rain Sensing Module
U0181	385	0181	Lost Communication With Headlamp Leveling Control Module	U0232	562	0232	Lost Communication With Side Obstacle Detection Control Module (Left)
U0182	386	0182	Lost Communication With Lighting Control Module (Front)	U0233	563	0233	Lost Communication With Side Obstacle Detection Control Module (Right)
U0183	387	0183	Lost Communication With Lighting Control Module (Rear)	U0234	564	0234	Lost Communication With Convenience Recall Module
U0184	388	0184	Lost Communication With Radio	U0235	565	0235	Lost Communication With Cruise Control Front Distance Range Sensor
U0185	389	0185	Lost Communication With Antenna Control Module	U0300	768	0300	Internal Control Module Software Incompatibility

U0301	769	0301	Software Incompatibility with ECM/PCM	U1024	4132	1024	SCP (J1850) Invalid or Missing Data for Primary Id
U0302	770	0302	Software Incompatibility with Transmission Control Module	U1025	4133	1025	SCP (J1850) Invalid or Missing Data for Primary Id
U0303	771	0303	Software Incompatibility with Transfer Case Control Module	U1026	4134	1026	SCP (J1850) Invalid or Missing Data for Engine RPM
U0304	772	0304	Software Incompatibility with G ear Shift Control Module	U1027	4135	1027	SCP (J1850) Invalid or Missing Data for Engine RPM
U0305	773	0305	Software Incompatibility with Cruise Control Module	U1028	4136	1028	SCP (J1850) Invalid or Missing Data for Primary Id
U0306	774	0306	Software Incompatibility with Fuel Injector Control Module	U1029	4137	1029	SCP (J1850) Invalid or Missing Data for Primary Id
U0307	775	0307	Software Incompatibility with G low Plug Control Module	U1030	4144	1030	SCP (J1850) Invalid or Missing Data for Experimental #1
U0308	776	0308	Software Incompatibility with Throttle Actuator Control Module	U1031	4145	1031	SCP (J1850) Invalid or Missing Data for Experimental #1
U0309	777	0309	Software Incompatibility with Alternative Fuel Control Module	U1032	4146	1032	SCP (J1850) Invalid or Missing Data for Primary Id
U0310	784	0310	Software Incompatibility with Fuel Pump Control Module	U1033	4147	1033	SCP (J1850) Invalid or Missing Data for Primary Id
U0311	785	0311	Software Incompatibility with Drive Motor Control Module	U1034	4148	1034	SCP (J1850) Invalid or Missing Data for Primary Id
U0312	786	0312	Software Incompatibility with Battery Energy Control Module A	U1035	4149	1035	SCP (J1850) Invalid or Missing Data for Primary Id
U0313	787	0313	Software Incompatibility with Battery Energy Control Module B	U1036	4150	1036	SCP (J1850) Invalid or Missing Data for Wheels
U0314	788	0314	Software Incompatibility with Four-Wheel Drive Clutch Control Module	U1037	4151	1037	SCP (J1850) Invalid or Missing Data for Wheels
U0315	789	0315	Software Incompatibility with Anti-Lock Brake System Control Module	U1038	4152	1038	SCP (J1850) Invalid or Missing Data for Primary Id
U0316	790	0316	Software Incompatibility with Vehicle Dynamics Control Module	U1039	4153	1039	SCP (J1850) Invalid or Missing Data for Primary Id / Vehicle Speed
U0317	791	0317	Software Incompatibility with Park Brake Control Module	U1040	4160	1040	SCP (J1850) Invalid or Missing Data for Vehicle Speed
U0318	792	0318	Software Incompatibility with Brake System Control Module	U1041	4161	1041	SCP (J1850) Invalid or Missing Data for Vehicle Speed
U0319	793	0319	Software Incompatibility with Steering Effort Control Module	U1042	4162	1042	SCP (J1850) Invalid or Missing Data for Traction Control
U0320	800	0320	Software Incompatibility with Power Steering Control Module	U1043	4163	1043	SCP (J1850) Invalid or Missing Data for Traction Control
U0321	801	0321	Software Incompatibility with Ride Level Control Module	U1044	4164	1044	SCP (J1850) Invalid or Missing Data for Traction Motor
U0322	802	0322	Software Incompatibility with Body Control Module	U1045	4165	1045	SCP (J1850) Invalid or Missing Data for Traction Motor
U0323	803	0323	Software Incompatibility with Instrument Panel Control Module	U1046	4166	1046	SCP (J1850) Invalid or Missing Data for Primary Id
U0324	804	0324	Software Incompatibility with HVAC Control Module	U1047	4167	1047	SCP (J1850) Invalid or Missing Data for Primary Id
U0325	805	0325	Software Incompatibility with Auxiliary Heater Control Module	U1048	4168	1048	SCP (J1850) Invalid or Missing Data for Primary Id
U0326	806	0326	Software Incompatibility with Vehicle Immobilizer Control Module	U1049	4169	1049	SCP (J1850) Invalid or Missing Data for Primary Id
U0327	807	0327	Software Incompatibility with Vehicle Security Control Module	U1050	4176	1050	SCP (J1850) Invalid or Missing Data for Brakes
U1000	4096	1000	SCP (J1850) Invalid or Missing Data for Primary Id	U1051	4177	1051	SCP (J1850) Invalid or Missing Data for Brakes
U1001	4097	1001	SCP (J1850) Invalid or Missing Data for Primary Id	U1052	4178	1052	SCP (J1850) Invalid or Missing Data for Steering / Steering Wheel
U1002	4098	1002	SCP (J1850) Invalid or Missing Data for Primary Id	U1053	4179	1053	SCP (J1850) Invalid or Missing Data for Steering / Steering Wheel
U1003	4099	1003	SCP (J1850) Invalid or Missing Data for Primary Id	U1054	4180	1054	SCP (J1850) Invalid or Missing Data for Primary Id
U1004	4100	1004	SCP (J1850) Invalid or Missing Data for EEC Programming	U1055	4181	1055	SCP (J1850) Invalid or Missing Data for Primary Id
U1005	4101	1005	SCP (J1850) Invalid or Missing Data for EEC Programming	U1056	4182	1056	SCP (J1850) Invalid or Missing Data for Vehicle Configuration
U1006	4102	1006	SCP (J1850) Invalid or Missing Data for Primary Id	U1057	4183	1057	SCP (J1850) Invalid or Missing Data for Vehicle Configuration
U1007	4103	1007	SCP (J1850) Invalid or Missing Data for Primary Id	U1058	4184	1058	SCP (J1850) Invalid or Missing Data for Transmission / Transaxle / PRNDL
U1008	4104	1008	SCP (J1850) Invalid or Missing Data for Engine Torque	U1059	4185	1059	SCP (J1850) Invalid or Missing Data for Transmission / Transaxle / PRNDL
U1009	4105	1009	SCP (J1850) Invalid or Missing Data for Engine Torque	U1060	4192	1060	SCP (J1850) Invalid or Missing Data for Primary Id
U1010	4112	1010	SCP (J1850) Invalid or Missing Data for Engine Air Intake	U1061	4193	1061	SCP (J1850) Invalid or Missing Data for Primary Id
U1011	4113	1011	SCP (J1850) Invalid or Missing Data for Engine Air Intake	U1062	4194	1062	SCP (J1850) Invalid or Missing Data for Primary Id
U1012	4114	1012	SCP (J1850) Invalid or Missing Data for Primary Id	U1063	4195	1063	SCP (J1850) Invalid or Missing Data for Primary Id
U1013	4115	1013	SCP (J1850) Invalid or Missing Data for Primary Id	U1064	4196	1064	SCP (J1850) Invalid or Missing Data for Primary Id
U1014	4116	1014	SCP (J1850) Invalid or Missing Data for Primary Id	U1065	4197	1065	SCP (J1850) Invalid or Missing Data for Primary Id
U1015	4117	1015	SCP (J1850) Invalid or Missing Data for Primary Id	U1066	4198	1066	SCP (J1850) Invalid or Missing Data for Primary Id
U1016	4118	1016	SCP (J1850) Invalid or Missing Data for Primary Id	U1067	4199	1067	SCP (J1850) Invalid or Missing Data for Primary Id
U1017	4119	1017	SCP (J1850) Invalid or Missing Data for Primary Id	U1068	4200	1068	SCP (J1850) Invalid or Missing Data for Primary Id
U1018	4120	1018	SCP (J1850) Invalid or Missing Data for Throttle	U1069	4201	1069	SCP (J1850) Invalid or Missing Data for Primary Id
U1019	4121	1019	SCP (J1850) Invalid or Missing Data for Throttle	U1070	4208	1070	SCP (J1850) Invalid or Missing Data for Engine Sensors
U1020	4128	1020	SCP (J1850) Invalid or Missing Data for Air Conditioning Clutch	U1071	4209	1071	SCP (J1850) Invalid or Missing Data for Engine Sensors
U1021	4129	1021	SCP (J1850) Invalid or Missing Data for Air Conditioning Clutch	U1072	4210	1072	SCP (J1850) Invalid or Missing Data for Engine Coolant
U1022	4130	1022	SCP (J1850) Invalid or Missing Data for Primary Id	U1073	4211	1073	SCP (J1850) Invalid or Missing Data for Engine Coolant
U1023	4131	1023	SCP (J1850) Invalid or Missing Data for Primary Id	U1074	4212	1074	SCP (J1850) Invalid or Missing Data for Engine Oil

U1075	4213	1075	SCP (J1850) Invalid or Missing Data for Engine Oil Temp	U1126	4390	1126	SCP (J1850) Invalid or Missing Data for Primary Id
U1076	4214	1076	SCP (J1850) Invalid or Missing Data for Primary Id	U1127	4391	1127	SCP (J1850) Invalid or Missing Data for Primary Id
U1077	4215	1077	SCP (J1850) Invalid or Missing Data for Primary Id	U1128	4392	1128	SCP (J1850) Invalid or Missing Data for Primary Id
U1078	4216	1078	SCP (J1850) Invalid or Missing Data for Primary Id	U1129	4393	1129	SCP (J1850) Invalid or Missing Data for Primary Id
U1079	4217	1079	SCP (J1850) Invalid or Missing Data for Primary Id	U1130	4400	1130	SCP (J1850) Invalid or Missing Data for Fuel System
U1080	4224	1080	SCP (J1850) Invalid or Missing Data for Primary Id	U1131	4401	1131	SCP (J1850) Invalid or Missing Data for Fuel System
U1081	4225	1081	SCP (J1850) Invalid or Missing Data for Primary Id	U1132	4402	1132	SCP (J1850) Invalid or Missing Data for Vehicle Motion
U1082	4226	1082	SCP (J1850) Invalid or Missing Data for Engine Systems Other	U1133	4403	1133	SCP (J1850) Invalid or Missing Data for Vehicle Motion
U1083	4227	1083	SCP (J1850) Invalid or Missing Data for Engine Systems Other	U1134	4404	1134	SCP (J1850) Invalid or Missing Data for Ignition Switch / Starter
U1084	4228	1084	SCP (J1850) Invalid or Missing Data for Powertrain Status Request	U1135	4405	1135	SCP (J1850) Invalid or Missing Data for Ignition Switch / Starter
U1085	4229	1085	SCP (J1850) Invalid or Missing Data for Powertrain Status Request	U1136	4406	1136	SCP (J1850) Invalid or Missing Data for Telltales
U1086	4230	1086	SCP (J1850) Invalid or Missing Data for Primary Id	U1137	4407	1137	SCP (J1850) Invalid or Missing Data for Telltales
U1087	4231	1087	SCP (J1850) Invalid or Missing Data for Primary Id	U1138	4408	1138	SCP (J1850) Invalid or Missing Data for Primary Id
U1088	4232	1088	SCP (J1850) Invalid or Missing Data for Suspension	U1139	4409	1139	SCP (J1850) Invalid or Missing Data for Primary Id
U1089	4233	1089	SCP (J1850) Invalid or Missing Data for Suspension	U1140	4416	1140	SCP (J1850) Invalid or Missing Data for Gateway
U1090	4240	1090	SCP (J1850) Invalid or Missing Data for Non-Legislated Diagnostics	U1141	4417	1141	SCP (J1850) Invalid or Missing Data for Gateway
U1091	4241	1091	SCP (J1850) Invalid or Missing Data for Non-Legislated Diagnostics	U1142	4418	1142	SCP (J1850) Invalid or Missing Data for Primary Id
U1092	4242	1092	SCP (J1850) Invalid or Missing Data for Primary Id	U1143	4419	1143	SCP (J1850) Invalid or Missing Data for Primary Id
U1093	4243	1093	SCP (J1850) Invalid or Missing Data for Primary Id	U1144	4420	1144	SCP (J1850) Invalid or Missing Data for Primary Id
U1094	4244	1094	SCP (J1850) Invalid or Missing Data for Experimental #2	U1145	4421	1145	SCP (J1850) Invalid or Missing Data for Primary Id
U1095	4245	1095	SCP (J1850) Invalid or Missing Data for Experimental #2	U1146	4422	1146	SCP (J1850) Invalid or Missing Data for Vehicle Security
U1096	4246	1096	SCP (J1850) Invalid or Missing Data for Primary Id	U1147	4423	1147	SCP (J1850) Invalid or Missing Data for Vehicle Security
U1097	4247	1097	SCP (J1850) Invalid or Missing Data for Primary Id	U1148	4424	1148	SCP (J1850) Invalid or Missing Data for Audio Control
U1098	4248	1098	SCP (J1850) Invalid or Missing Data for Vehicle Speed Control	U1149	4425	1149	SCP (J1850) Invalid or Missing Data for Audio Control
U1099	4249	1099	SCP (J1850) Invalid or Missing Data for Vehicle Speed Control	U1150	4432	1150	SCP (J1850) Invalid or Missing Data for Audible Warnings
U1100	4352	1100	SCP (J1850) Invalid or Missing Data for Primary Id	U1151	4433	1151	SCP (J1850) Invalid or Missing Data for Audible Warnings
U1101	4353	1101	SCP (J1850) Invalid or Missing Data for Primary Id	U1152	4434	1152	SCP (J1850) Invalid or Missing Data for Experimental #3
U1102	4354	1102	SCP (J1850) Invalid or Missing Data for Primary Id	U1153	4435	1153	SCP (J1850) Invalid or Missing Data for Experimental #3
U1103	4355	1103	SCP (J1850) Invalid or Missing Data for Primary Id	U1154	4436	1154	SCP (J1850) Invalid or Missing Data for Compact Disc
U1104	4356	1104	SCP (J1850) Invalid or Missing Data for Chassis Status Request	U1155	4437	1155	SCP (J1850) Invalid or Missing Data for Compact Disc
U1105	4357	1105	SCP (J1850) Invalid or Missing Data for Chassis Status Request	U1156	4438	1156	SCP (J1850) Invalid or Missing Data for Digital Signal Processing
U1106	4358	1106	SCP (J1850) Invalid or Missing Data for Legislated Diagnostics	U1157	4439	1157	SCP (J1850) Invalid or Missing Data for Digital Signal Processing
U1107	4359	1107	SCP (J1850) Invalid or Missing Data for Legislated Diagnostics	U1158	4440	1158	SCP (J1850) Invalid or Missing Data for Antenna
U1108	4360	1108	SCP (J1850) Invalid or Missing Data for Electric Traction Drive (Inverter)	U1159	4441	1159	SCP (J1850) Invalid or Missing Data for Antenna
U1109	4361	1109	SCP (J1850) Invalid or Missing Data for Electric Traction Drive (Inverter)	U1160	4448	1160	SCP (J1850) Invalid or Missing Data for Primary Id
U1110	4368	1110	SCP (J1850) Invalid or Missing Data for Primary Id	U1161	4449	1161	SCP (J1850) Invalid or Missing Data for Primary Id
U1111	4369	1111	SCP (J1850) Invalid or Missing Data for Primary Id	U1162	4450	1162	SCP (J1850) Invalid or Missing Data for Digital Audio Tape
U1112	4370	1112	SCP (J1850) Invalid or Missing Data for Primary Id	U1163	4451	1163	SCP (J1850) Invalid or Missing Data for Digital Audio Tape
U1113	4371	1113	SCP (J1850) Invalid or Missing Data for Primary Id	U1164	4452	1164	SCP (J1850) Invalid or Missing Data for Tuner / Receiver
U1114	4372	1114	SCP (J1850) Invalid or Missing Data for Charging System	U1165	4453	1165	SCP (J1850) Invalid or Missing Data for Tuner / Receiver
U1115	4373	1115	SCP (J1850) Invalid or Missing Data for Charging System	U1166	4454	1166	SCP (J1850) Invalid or Missing Data for Cassette Tape
U1116	4374	1116	SCP (J1850) Invalid or Missing Data for Electrical Energy Management	U1167	4455	1167	SCP (J1850) Invalid or Missing Data for Cassette Tape
U1117	4375	1117	SCP (J1850) Invalid or Missing Data for Electrical Energy Management	U1168	4456	1168	SCP (J1850) Invalid or Missing Data for Primary Id
U1118	4376	1118	SCP (J1850) Invalid or Missing Data for Primary Id	U1169	4457	1169	SCP (J1850) Invalid or Missing Data for Primary Id
U1119	4377	1119	SCP (J1850) Invalid or Missing Data for Primary Id	U1170	4464	1170	SCP (J1850) Invalid or Missing Data for Cellular Phone / Paging System
U1120	4384	1120	SCP (J1850) Invalid or Missing Data for Primary Id	U1171	4465	1171	SCP (J1850) Invalid or Missing Data for Cellular Phone / Paging System
U1121	4385	1121	SCP (J1850) Invalid or Missing Data for Primary Id	U1172	4466	1172	SCP (J1850) Invalid or Missing Data for Remote Button Control
U1122	4386	1122	SCP (J1850) Invalid or Missing Data for Odometer	U1173	4467	1173	SCP (J1850) Invalid or Missing Data for Remote Button Control
U1123	4387	1123	SCP (J1850) Invalid or Missing Data for Odometer	U1174	4468	1174	SCP (J1850) Invalid or Missing Data for Primary Id
U1124	4388	1124	SCP (J1850) Invalid or Missing Data for Primary Id	U1175	4469	1175	SCP (J1850) Invalid or Missing Data for Primary Id
U1125	4389	1125	SCP (J1850) Invalid or Missing Data for Primary Id	U1176	4470	1176	SCP (J1850) Invalid or Missing Data for Primary Id

U1177	4471	1177	SCP (J1850) Invalid or Missing Data for Primary Id	U1228	4648	1228	SCP (J1850) Invalid or Missing Data for Tires
U1178	4472	1178	SCP (J1850) Invalid or Missing Data for Climate Control (HVAC)	U1229	4649	1229	SCP (J1850) Invalid or Missing Data for Tires
U1179	4473	1179	SCP (J1850) Invalid or Missing Data for Climate Control (HVAC)	U1230	4656	1230	SCP (J1850) Invalid or Missing Data for Electric Defrost
U1180	4480	1180	SCP (J1850) Invalid or Missing Data for Personalization (Memory) Features	U1231	4657	1231	SCP (J1850) Invalid or Missing Data for Electric Defrost
U1181	4481	1181	SCP (J1850) Invalid or Missing Data for Personalization (Memory) Features	U1232	4658	1232	SCP (J1850) Invalid or Missing Data for Navigation
U1182	4482	1182	SCP (J1850) Invalid or Missing Data for Primary Id	U1233	4659	1233	SCP (J1850) Invalid or Missing Data for Navigation
U1183	4483	1183	SCP (J1850) Invalid or Missing Data for Primary Id	U1234	4660	1234	SCP (J1850) Invalid or Missing Data for Displays
U1184	4484	1184	SCP (J1850) Invalid or Missing Data for Window Wiper / Washer	U1235	4661	1235	SCP (J1850) Invalid or Missing Data for Displays
U1185	4485	1185	SCP (J1850) Invalid or Missing Data for Window Wiper / Washer	U1236	4662	1236	SCP (J1850) Invalid or Missing Data for Memory Storage
U1186	4486	1186	SCP (J1850) Invalid or Missing Data for Primary Id	U1237	4663	1237	SCP (J1850) Invalid or Missing Data for Memory Storage
U1187	4487	1187	SCP (J1850) Invalid or Missing Data for Primary Id	U1238	4664	1238	SCP (J1850) Invalid or Missing Data for Experimental #4
U1188	4488	1188	SCP (J1850) Invalid or Missing Data for Primary Id	U1239	4665	1239	SCP (J1850) Invalid or Missing Data for Experimental #4
U1189	4489	1189	SCP (J1850) Invalid or Missing Data for Primary Id	U1240	4672	1240	SCP (J1850) Invalid or Missing Data for Primary Id
U1190	4496	1190	SCP (J1850) Invalid or Missing Data for Primary Id	U1241	4673	1241	SCP (J1850) Invalid or Missing Data for Primary Id
U1191	4497	1191	SCP (J1850) Invalid or Missing Data for Primary Id	U1242	4674	1242	SCP (J1850) Invalid or Missing Data for Exterior Environment
U1192	4498	1192	SCP (J1850) Invalid or Missing Data for Primary Id	U1243	4675	1243	SCP (J1850) Invalid or Missing Data for Exterior Environment
U1193	4499	1193	SCP (J1850) Invalid or Missing Data for Primary Id	U1244	4676	1244	SCP (J1850) Invalid or Missing Data for Interior Environment
U1194	4500	1194	SCP (J1850) Invalid or Missing Data for Mirrors	U1245	4677	1245	SCP (J1850) Invalid or Missing Data for Interior Environment
U1195	4501	1195	SCP (J1850) Invalid or Missing Data for Mirrors	U1246	4678	1246	SCP (J1850) Invalid or Missing Data for Primary Id
U1196	4502	1196	SCP (J1850) Invalid or Missing Data for Door Locks	U1247	4679	1247	SCP (J1850) Invalid or Missing Data for Primary Id
U1197	4503	1197	SCP (J1850) Invalid or Missing Data for Door Locks	U1248	4680	1248	SCP (J1850) Invalid or Missing Data for Time / Date
U1198	4504	1198	SCP (J1850) Invalid or Missing Data for External Access (Doors)	U1249	4681	1249	SCP (J1850) Invalid or Missing Data for Time / Date
U1199	4505	1199	SCP (J1850) Invalid or Missing Data for External Access (Doors)	U1250	4688	1250	SCP (J1850) Invalid or Missing Data for Vehicle Id (VIN)
U1200	4608	1200	SCP (J1850) Invalid or Missing Data for Seat Motion / Control	U1251	4689	1251	SCP (J1850) Invalid or Missing Data for Vehicle Id (VIN)
U1201	4609	1201	SCP (J1850) Invalid or Missing Data for Seat Motion / Control	U1252	4690	1252	SCP (J1850) Invalid or Missing Data for Class A Functions
U1202	4610	1202	SCP (J1850) Invalid or Missing Data for Windows	U1253	4691	1253	SCP (J1850) Invalid or Missing Data for Class A Functions
U1203	4611	1203	SCP (J1850) Invalid or Missing Data for Windows	U1254	4692	1254	SCP (J1850) Invalid or Missing Data for Network Control
U1204	4612	1204	SCP (J1850) Invalid or Missing Data for Steering Column	U1255	4693	1255	SCP (J1850) Invalid or Missing Data for Network Control
U1205	4613	1205	SCP (J1850) Invalid or Missing Data for Steering Column	U1260	4704	1260	SCP (J1850) Single Ended (+) Circuit Failure
U1206	4614	1206	SCP (J1850) Invalid or Missing Data for Primary Id	U1261	4705	1261	SCP (J1850) Single Ended (-) Circuit Failure
U1207	4615	1207	SCP (J1850) Invalid or Missing Data for Primary Id	U1262	4706	1262	SCP (J1850) Communication Bus Fault
U1208	4616	1208	SCP (J1850) Invalid or Missing Data for Seat Switches	U1308	4872	1308	SCP (J1850) Invalid or Missing Data for Function Read Engine Torque
U1209	4617	1209	SCP (J1850) Invalid or Missing Data for Seat Switches	U1341	4929	1341	SCP (J1850) Invalid or Missing Data for Function Read Vehicle Speed
U1210	4624	1210	SCP (J1850) Invalid or Missing Data for Restraints	U1430	5168	1430	SCP (J1850) Invalid or Missing Data for Function Read Fuel System
U1211	4625	1211	SCP (J1850) Invalid or Missing Data for Restraints	U1451	5201	1451	SCP (J1850) Invalid or Missing Data for Function Read Audible Warnings / Anti-
U1212	4626	1212	SCP (J1850) Invalid or Missing Data for Primary Id				Theft Module, Vehicle Immobilized
U1213	4627	1213	SCP (J1850) Invalid or Missing Data for Primary Id	U1612	5650	1612	SCP (J1850) Lack of Acknowledgment for Primary Id
U1214	4628	1214	SCP (J1850) Invalid or Missing Data for Primary Id	U1736	5942	1736	SCP (J1850) Lack of Acknowledgment for Telltales
U1215	4629	1215	SCP (J1850) Invalid or Missing Data for Primary Id	U1750	5968	1750	SCP (J1850) Lack of Acknowledgment for Audible Warnings
U1216	4630	1216	SCP (J1850) Invalid or Missing Data for External Lamp Outage	U1794	6036	1794	SCP (J1850) Lack of Acknowledgment for Mirrors
U1217	4631	1217	SCP (J1850) Invalid or Missing Data for External Lamp Outage	U1797	6039	1797	SCP (J1850) Lack of Acknowledgment for Door Locks
U1218	4632	1218	SCP (J1850) Invalid or Missing Data for External Lamps	U1798	6040	1798	SCP (J1850) Lack of Acknowledgment for External Access (Doors)
U1219	4633	1219	SCP (J1850) Invalid or Missing Data for External Lamps	U1806	6150	1806	SCP (J1850) Lack of Acknowledgment for Primary Id
U1220	4640	1220	SCP (J1850) Invalid or Missing Data for Interior Lamp Outage	U1900	6400	1900	CAN Communication Bus Fault
U1221	4641	1221	SCP (J1850) Invalid or Missing Data for Interior Lamp Outage	U1950	6480	1950	UPB Communication Bus Fault
U1222	4642	1222	SCP (J1850) Invalid or Missing Data for Interior Lamps	U2000	8192	2000	Audio Rear Control Unit is Not Responding
U1223	4643	1223	SCP (J1850) Invalid or Missing Data for Interior Lamps	U2001	8193	2001	Audio Tape Deck Unit is Not Responding
U1224	4644	1224	SCP (J1850) Invalid or Missing Data for Primary Id	U2002	8194	2002	Audio Bezel is Not Responding
U1225	4645	1225	SCP (J1850) Invalid or Missing Data for Primary Id	U2003	8195	2003	Audio Compact Disk / Disk Jockey Unit is Not Responding
U1226	4646	1226	SCP (J1850) Invalid or Missing Data for Body Status Request	U2004	8196	2004	Audio Steering Wheel Control Unit is Not Responding
U1227	4647	1227	SCP (J1850) Invalid or Missing Data for Body Status Request	U2005	8197	2005	Audio Rear Integrated Control Panel Unit is Not Responding

U2006	8198	2006	Audio Remote Climate Control Unit is Not Responding
U2007	8199	2007	Audio Navigation Unit is Not Responding
U2008	8200	2008	Audio Phone is Not Responding
U2009	8201	2009	Audio Front Control Module (ACM) is Not Responding
U2010	8208	2010	Module is Not Responding (Non SCP)
U2011	8209	2011	Module Transmitted Invalid Data (Non SCP)
U2012	8210	2012	Communication Bus Error (Non SCP)
U2013	8211	2013	Compass Module is not Responding
U2014	8212	2014	Audio Subwoofer Unit is Not Responding
U2015	8213	2015	Signal Link Fault (Non SCP)
U2016	8214	2016	Signal Link Short to Ground (Non SCP) / From NGV Module
U2017	8215	2017	Driver Side Crash Sensor Communication Fault (Non SCP)
U2018	8216	2018	Passenger Side Crash Sensor Communication Fault (Non SCP)
U2019	8217	2019	Audio Voice Module Not Responding
U2020	8224	2020	Audio Center Amp is not responding
U2021	8225	2021	Invalid /fault data received (Non SCP)
U2150	8528	2150	SCP (J1850) Invalid Data from REM
U2152	8530	2152	SCP (J1850) Invalid Data from GEM
U2160	8544	2160	SCP (J1850) Invalid Data from IC
U2195	8597	2195	SCP (J1850) Invalid Data from SCLM

